

MM1-1140HS

GaAs Double-Balanced Mixer

DEVICE OVERVIEW

General Description

The MM1-1140H is a passive double balanced MMIC mixer. It features excellent conversion loss, superior isolations and spurious performance across a broad bandwidth, in a highly miniaturized form factor. Accurate, nonlinear simulation models are available for Microwave Office® through the Marki Microwave PDK. The MM1-1140H is available as a wire bondable chip or in a connectorized package. The MM1-1140H is a superior alternative to Marki Microwave carrier and packaged M1 and M9 mixers.

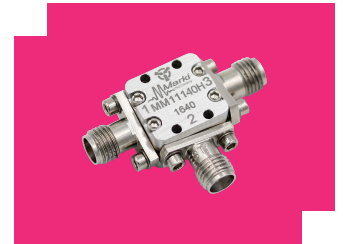

Features

- CAD Optimized for Superior Isolation and Spurious Response
- Broadband Performance
- Excellent Unit-to-Unit Repeatability
- Fully nonlinear software models available with Marki PDK for Microwave Office®
- RoHS Compliant

Applications

- Mobile test and measurement equipment
- 5G transceivers

Functional Block Diagram

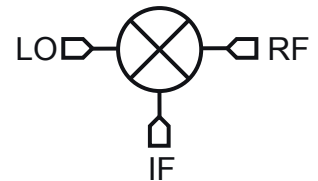

Part Ordering Options

Part Number	Description	Package	Connectors	Green Status	Product Lifecycle	Export Classification
MM1-1140HS	GaAs Double-Balanced Mixer	S	<u>Standard</u>	REACH RoHS	Released	EAR99

Table Of Contents

- **Device Overview**
 - General Description
 - Features
 - Applications
 - Functional Block Diagram
- **Port Configuration and Functions**
 - Port Diagram
 - Port Functions
- **Revision History**
- **Specifications**
 - Absolute Maximum Ratings
 - Package Information
 - Recommended Operating Conditions
 - Electrical Specifications
 - Typical Performance Plots
 - Spur Tables
- **Mechanical Data**
 - Outline Drawing
- **Notes**

Revision History

Revision Code	Revision Date	Comment
A	2017-10-01	Die shrunk from 1.48 x 1.18 micron to 1.37 x 1.17 micron. Die tolerance added.

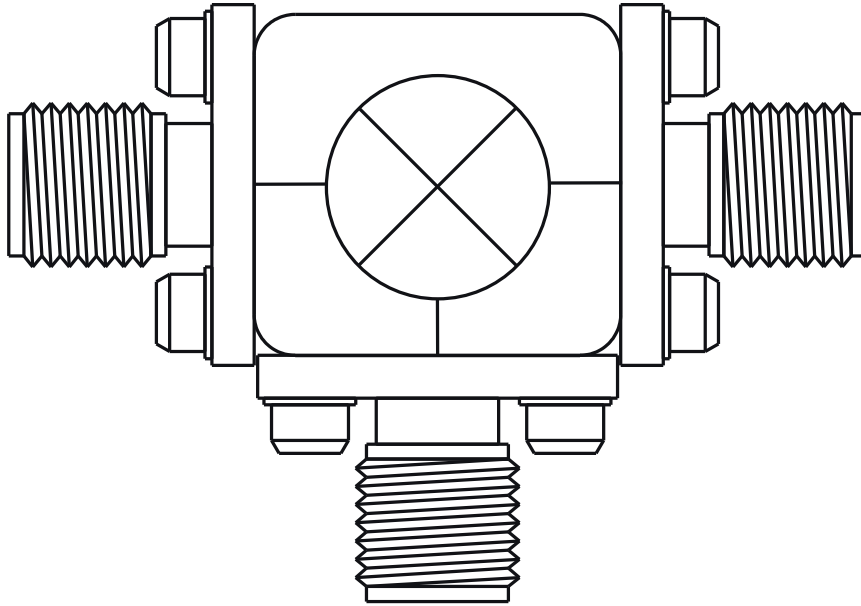

Port Configuration and Functions

Port Diagram



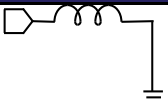
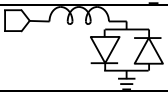

Port Functions

Configuration A

Port	Function	Connector Type	Description	Equivalent Circuit for Package
Port 1	LO	2.92F	Port 1 is DC short to ground and AC matched to 50 Ohms from 11 to 40 GHz. Blocking capacitor is optional.	
Port 2	IF	SMAF	Port 2 is DC coupled to the diodes. Blocking capacitor is optional.	
Port 3	RF	2.92F	Port 3 is DC open and AC matched to 50 Ohms from 11 to 40 GHz. Blocking capacitor is optional.	

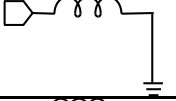
Configuration B

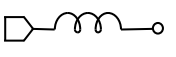
Port	Function	Connector Type	Description	Equivalent Circuit for Package
Port 1	RF	2.92F	Port 1 is DC short to ground and AC matched to 50 Ohms from 11 to 40 GHz. Blocking capacitor is optional.	
Port 2	IF	SMAF	Port 2 is DC coupled to the diodes. Blocking capacitor is optional.	
Port 3	LO	2.92F	Port 3 is DC open and AC matched to 50 Ohms from 11 to 40 GHz. Blocking capacitor is optional.	

Specifications

Absolute Maximum Ratings

Parameter	Maximum Rating	Unit
Maximum Operating Temperature	100	°C
Maximum Storage Temperature	125	°C
Minimum Operating Temperature	-55	°C
Minimum Storage Temperature	-65	°C
Port 1 DC Current	15	mA
Port 2 DC Current	24	mA
RF Power Handling (RF+LO), 100°C	21	dBm
RF Power Handling (RF+LO), 25°C	25	dBm

Package Information

Parameter	Details	Rating
Dimensions	-	14.22 x 13.21mm

Recommended Operating Conditions

Parameter	Min	Nominal	Max	Unit
LO Input Power	12	-	20	-

Electrical Specifications

Specifications guaranteed from -55 to +100°C, measured in a 50Ω system. All bare die are 100% DC tested and 100% visual inspected. RF testing is performed on a sample basis to verify conformance to datasheet guaranteed specifications. Consult factory for more information.

Parameter	Port Configuration	Test Conditions	Min	Typ	Max	Unit
Conversion Loss	A	LO/RF=11-40 GHz IF=DC-12 GHz LO drive level=15 dBm	-	8	14	dB
Input 1 dB Compression	A	LO/RF=11-40 GHz IF=DC-12 GHz LO drive level=13-20 dBm	-	9	-	dBm
Input IP3	A	LO/RF=11-40 GHz IF=DC-12 GHz LO drive level=13-20 dBm	-	21	-	dBm
Isolation, LO to RF	A	-	-	47	-	dB
Conversion Loss	B	LO/RF=11-40 GHz IF=DC-12 GHz LO drive level=15 dBm	-	9	16	dB
Input 1 dB Compression	B	LO/RF=11-40 GHz IF=DC-12 GHz LO Drive level=12-17 dBm	-	9	-	dBm
Input IP3	B	LO/RF=11-40 GHz IF=DC-12 GHz LO drive level=12-17 dBm	-	23	-	dBm
IF Frequency Range	-	-	0	-	12	GHz
LO Frequency Range	-	-	11	-	40	GHz
RF Frequency Range	-	-	11	-	40	GHz

Typical Performance Plots

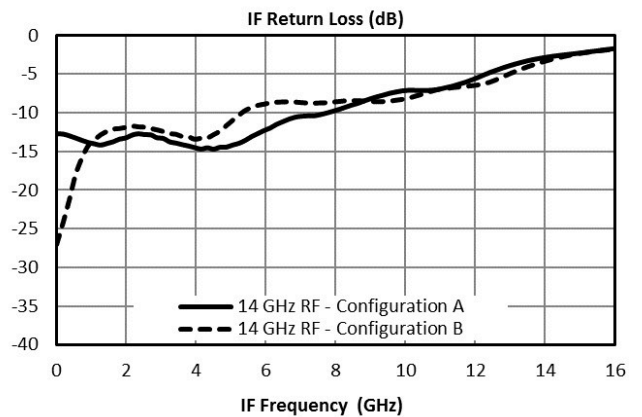
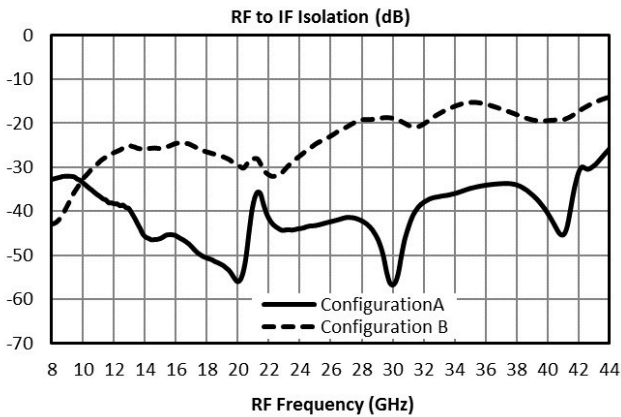
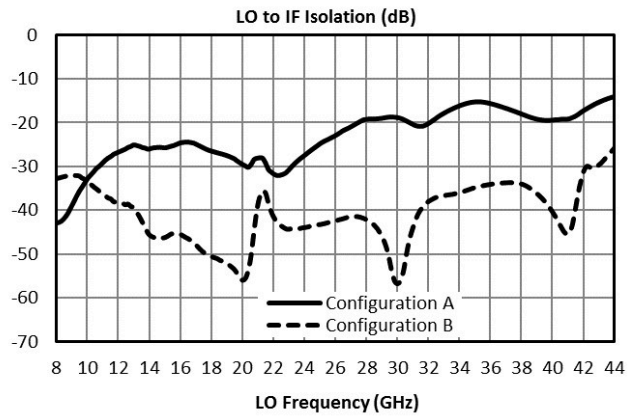
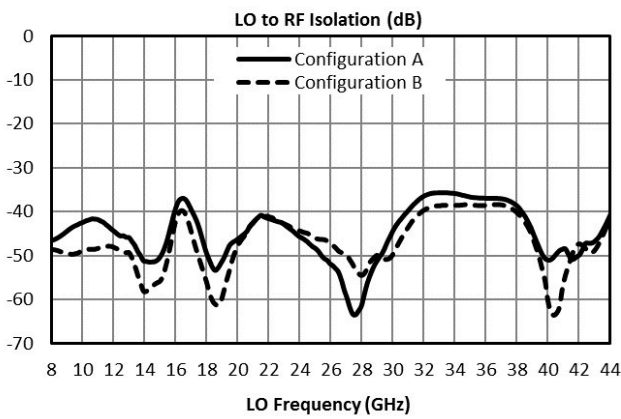
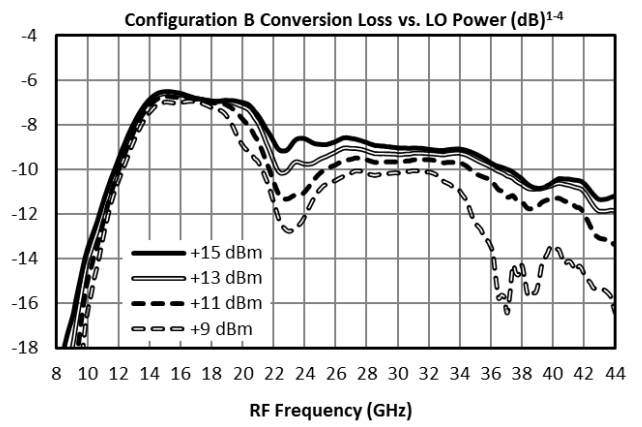
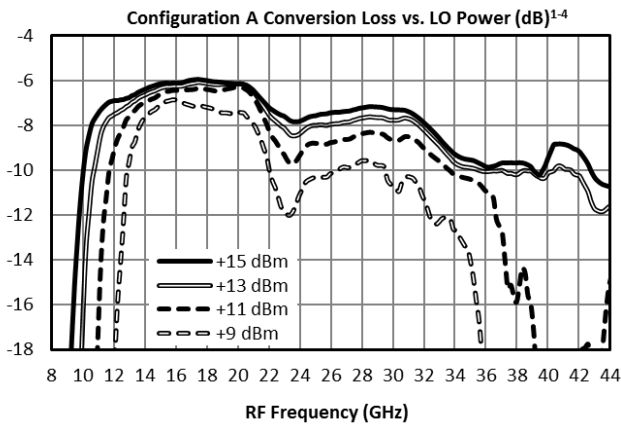
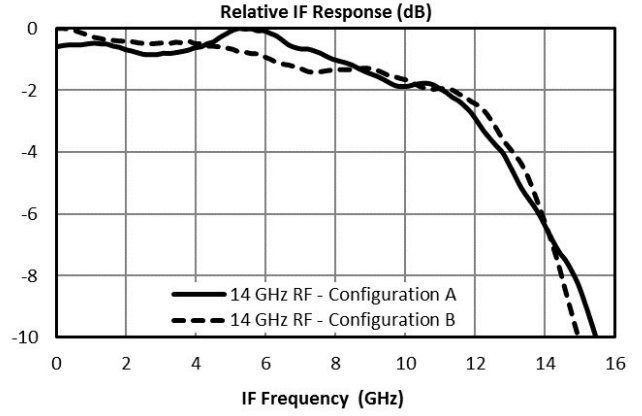
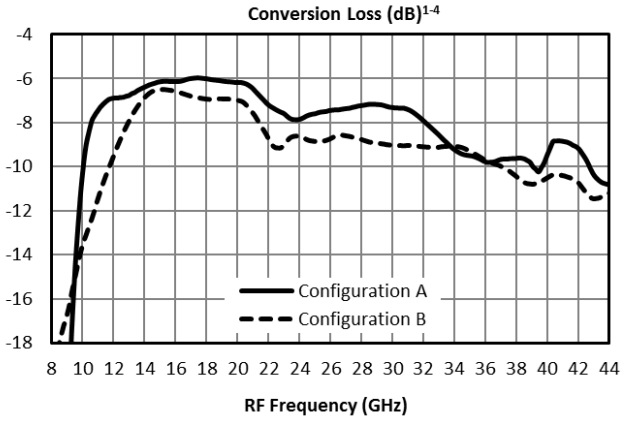

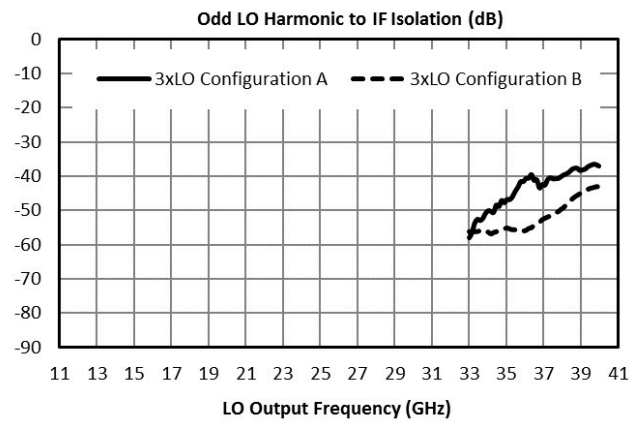
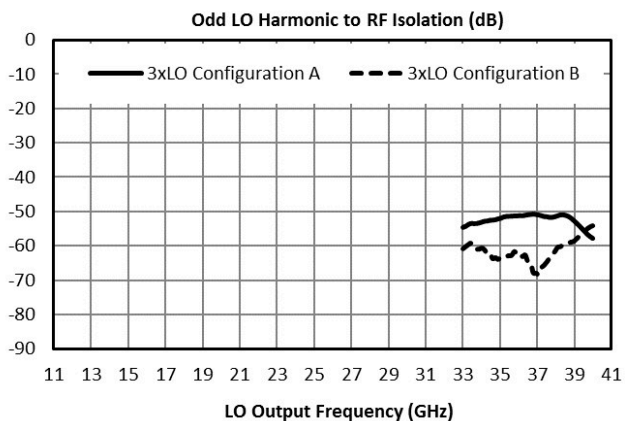
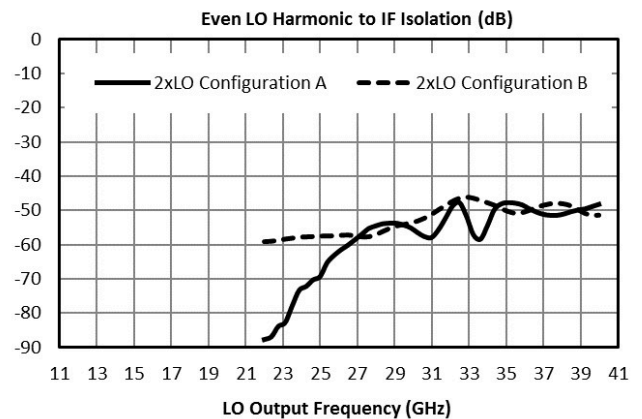
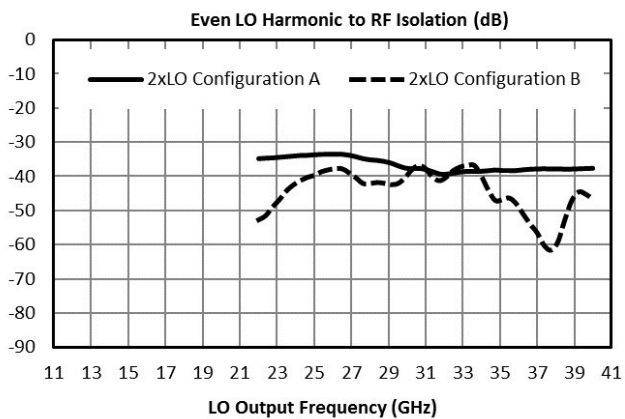
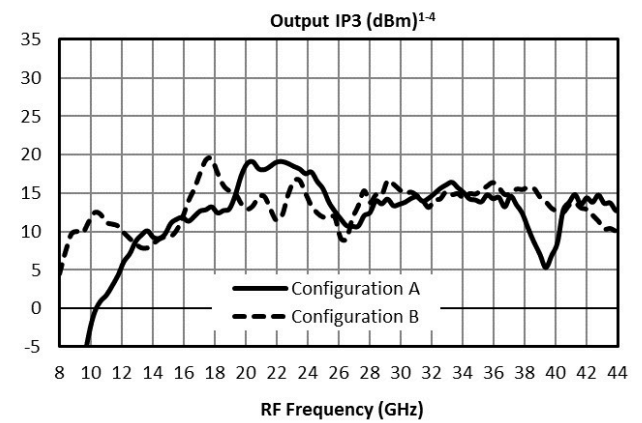
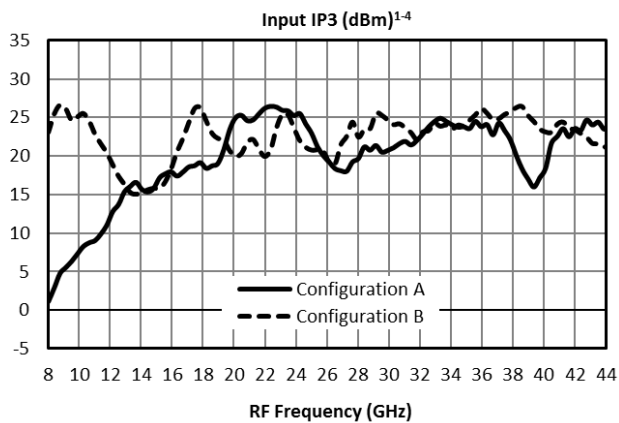
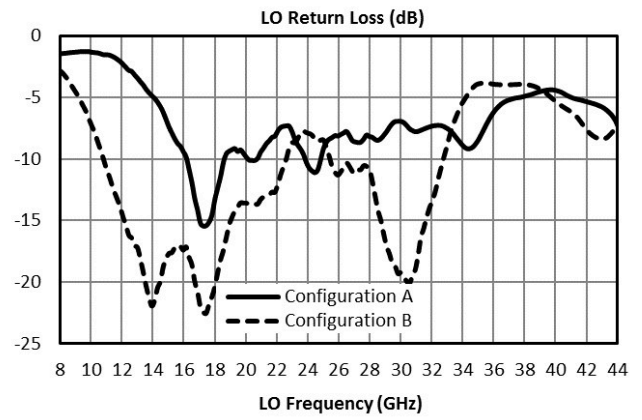
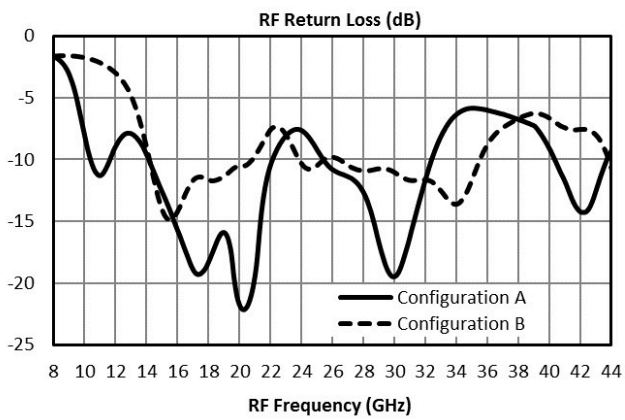

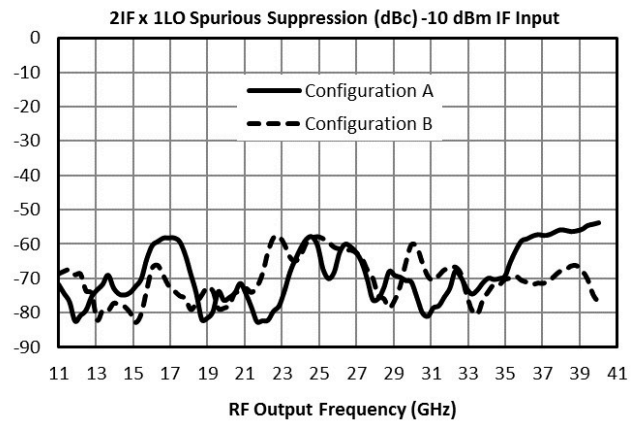
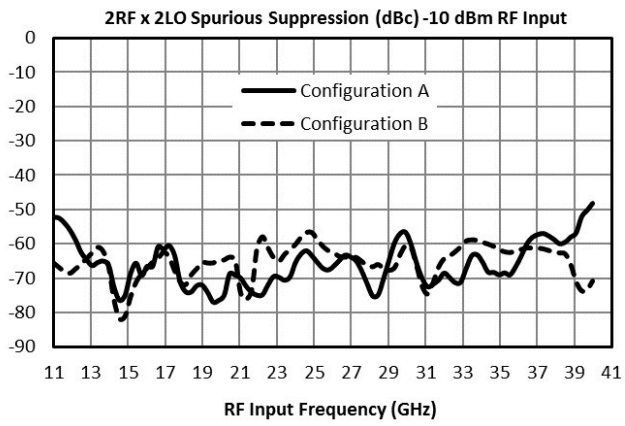

Spur Table

Downconversion Spurious Suppression

Spurious data is taken by selecting RF and LO frequencies (+mLO+nRF) within the RF/LO bands, to create a spurious output within the IF output band. The mixer is swept across the full spurious band and the mean is calculated. The numbers shown in the table below are for a -10 dBm RF input. Spurious suppression is scaled for different RF power levels by (n-1), where “n” is the RF spur order. For example, the 2RFx2LO spur is 66 dBc for the A configuration for a -10 dBm input, so a -20 dBm RF input creates a spur that is (2-1) x (-10 dB) dB lower, or 76 dBc.

Typical Downconversion Spurious Suppression (dBc): A Configuration (B Configuration)⁴

-10 dBm RF Input	0xLO	1xLO	2xLO	3xLO	4xLO	5xLO
1xRF	34 (15)	Reference	33 (36)	15 (11)	37 (34)	N/A
2xRF	73 (71)	53 (57)	66 (65)	62 (56)	62 (69)	61 (56)
3xRF	85 (79)	57 (68)	78 (83)	69 (71)	77 (87)	63 (69)
4xRF	N/A	88 (116)	102 (105)	101 (101)	108 (111)	105 (104)
5xRF	N/A	106 (124)	111 (123)	115 (124)	117 (128)	114 (118)

Upconversion Spurious Suppression

Spurious data is taken by mixing an input within the IF band, with LO frequencies (+mLO+nIF), to create a spurious output within the RF output band. The mixer is swept across the full spurious output band and the mean is calculated. The numbers shown in the table below are for a -10 dBm IF input. Spurious suppression is scaled for different IF input power levels by (n-1), where “n” is the IF spur order. For example, the 2IFx1LO spur is typically 69 dBc for the A configuration for a -10 dBm input, so a -20 dBm IF input creates a spur that is (2-1) x (-10 dB) dB lower, or 79 dBc.

Typical Upconversion Spurious Suppression (dBc): A Configuration (B Configuration)⁴

-10 dBm IF Input	0xLO	1xLO	2xLO	3xLO	4xLO	5xLO
1xIF	33 (20)	Reference	42 (38)	15 (10)	36 (35)	19 (26)
2xIF	60 (64)	69 (70)	59 (57)	63 (64)	55 (54)	62 (70)
3xIF	93 (91)	70 (64)	79 (81)	67 (62)	74 (83)	63 (70)
4xIF	114 (106)	104 (103)	101 (95)	108 (103)	100 (91)	97 (110)
5xIF	125 (122)	113 (108)	118 (119)	117 (111)	115 (117)	98 (107)

Mechanical Data

Outline Drawing

Download : [Outline 2D Drawing](#) | [Outline 3D Drawing](#) | [Outline 3D STP](#)

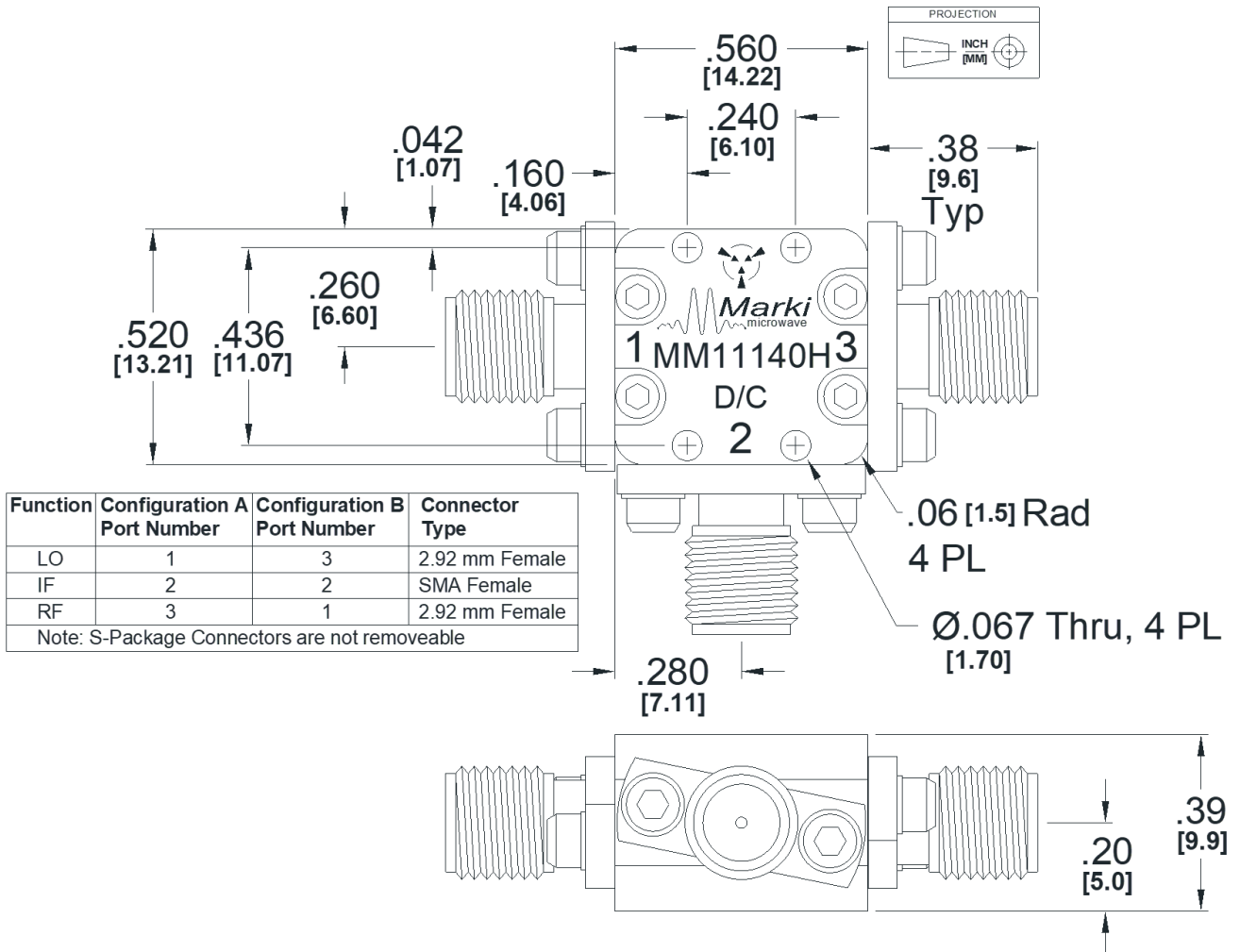

Notes

1. Mixer Conversion Loss Plot IF frequency is 91 MHz.
2. Mixer Noise Figure typically measures within 0.5 dB of conversion loss for IF frequencies greater than 5 MHz.
3. Conversion Loss typically degrades less than 0.5 dB at +100°C and improves less than 0.5 dB at -55°C.
4. Unless otherwise specified, data is taken with +15 dBm LO drive.
5. Specifications are subject to change without notice. Contact Marki Microwave for the most recent specifications and data sheets.
6. Catalog mixer circuits are continually improved. Configuration control requires custom mixer model numbers and specifications.

DISCLAIMER

MARKI MICROWAVE, INC., ("MARKI") PROVIDES TECHNICAL SPECIFICATIONS AND DATA (INCLUDING DATASHEETS), APPLICATION OR OTHER DESIGN ADVICE, WEB TOOLS, AND OTHER INFORMATION AND RESOURCES "AS IS" AND WITH ALL FAULTS. MARKI DISCLAIMS ALL WARRANTIES, EXPRESS OR IMPLIED, INCLUDING, WITHOUT LIMITATION, ANY IMPLIED WARRANTIES OF MERCHANTABILITY, FITNESS FOR A PARTICULAR PURPOSE, OR NON-INFRINGEMENT. These resources are intended for developers skilled in the art designing with Marki products. You are solely responsible for (1) selecting the appropriate products for your application, (2) designing, validating, and testing your application, and (3) ensuring your application meets applicable standards and other requirements. Marki makes no guarantee regarding the suitability of its products for any particular purpose, nor does Marki assume any liability whatsoever arising out of your use or application of any Marki product.

Marki grants you permission to use these resources only for development of an application that uses Marki products. Other reproduction or use of these resources is strictly prohibited. No license is granted to any other Marki intellectual property or to any third-party intellectual property. Marki reserves the right to make changes to the product(s) or information contained herein without notice.

MARKI MICROWAVE and T3 MIXER are trademarks or registered trademarks of Marki Microwave, Inc. All other trademarks used are the property of their respective owners.

© 2017, Marki Microwave, Inc