

MM1-1044LS

Low Power GaAs MMIC Double Balanced Mixer

DEVICE OVERVIEW

General Description

The MM1-1044L is a low power GaAs MMIC double balanced mixer that is designed for and operates at the K and Ka band 5G frequencies. MM1-1044L is a low power Ka band mixer that works well as both an up and down converter. This mixer offers low conversion loss and high LO to RF isolations over a broadband Ku to Ka band. The sister MM1-1044H is recommended for high linearity applications. The MM1-1044L is available as both wire bondable die and as connectorized modules.

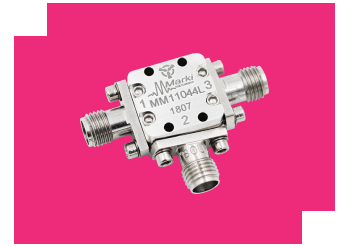

Features

- Low +7 dBm minimum input drive
- Low cost Ka band mixer
- 5G band coverage

Applications

- Test and Measurement Equipment
- 5G
- Power efficient modules

Functional Block Diagram

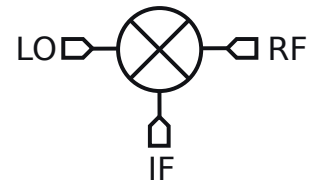

Part Ordering Options

Part Number	Description	Package	Connectors	Green Status	Product Lifecycle	Export Classification
MM1-1044LS-KKS	Low Power GaAs MMIC Double Balanced Mixer	S	<u>Standard</u>	REACH RoHS	Released	EAR99
MM1-1044LS	Low Power GaAs MMIC Double Balanced Mixer	S	<u>Standard</u>	REACH RoHS	Released	EAR99

MM1-1044LS

Low Power GaAs MMIC Double Balanced Mixer

Table Of Contents

- **Device Overview**

- General Description
- Features
- Applications
- Functional Block Diagram

- **Port Configuration and Functions**

- Port Diagram
- Port Functions

- **Revision History**

- **Specifications**

- Absolute Maximum Ratings
- Package Information
- Recommended Operating Conditions
- Sequencing Requirements
- Electrical Specifications
- Typical Performance Plots
- Typical Performance Plots: IP3
- Typical Performance Plots: LO Harmonic Isolation
- Spur Tables

- **Mechanical Data**

- Outline Drawing

Revision History

Revision Code	Revision Date	Comment
-	2018-02-01	Datasheet Initial Release
A	2020-02-01	Correction to Spur Chart
B	2020-03-01	Power Handling Updated

Port Configuration and Functions

Port Diagram

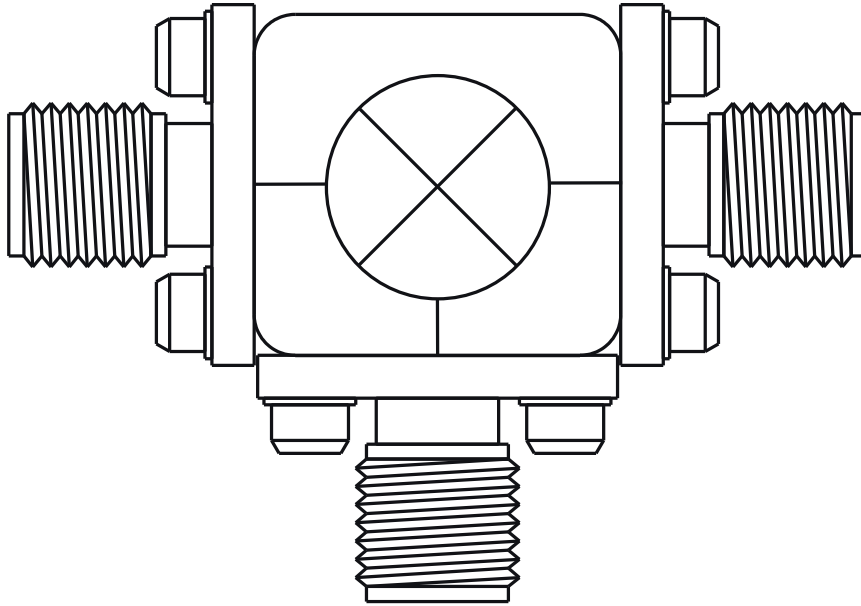



The MM1-1044L has the input and output ports given in Port Functions. The MM1-1044L can be used in either an up or down conversion. For configuration A, input the LO into port 1, use port 3 for the RF, and port 2 for the IF. For configuration B, input the LO into port 3, use port 1 for the RF, and port 2 for the IF.

Port Functions

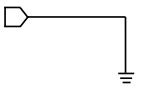
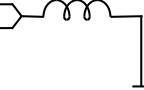
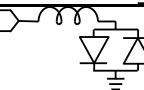
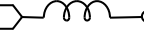
Configuration A

Port	Function	Connector Type	Description	DC Equivalent Circuit
GND	Ground	-	S package ground provided through metal housing and outer coax conductor.	
Port 1	LO	2.4F	Port 1 is DC short for the CH and S packages.	
Port 2	IF	SMAF	Port 2 is diode connected for the CH and S package.	
Port 3	RF	2.4F	Port 3 is DC open for the CH and S packages.	

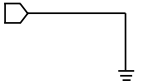
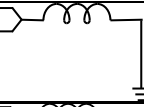
Configuration B

Port	Function	Connector Type	Description	DC Equivalent Circuit
GND	Ground	-	S package ground provided through metal housing and outer coax conductor.	
Port 1	RF	2.4F	Port 1 is DC short for the CH and S packages.	
Port 2	IF	SMAF	Port 2 is diode connected for the CH and S package.	
Port 3	LO	-	Port 3 is DC open for the CH and S packages.	

Specifications

Absolute Maximum Ratings

The Absolute Maximum Ratings indicate limits beyond which damage may occur to the device. If these limits are exceeded, the device may be inoperable or have a reduced lifetime.

Parameter	Maximum Rating	Unit
Maximum Operating Temperature	100	°C
Maximum Storage Temperature	125	°C
Minimum Operating Temperature	-55	°C
Minimum Storage Temperature	-65	°C
RF Power Handling (RF+LO)	30	dBm

Package Information

Parameter	Details	Rating
Weight	Package name: S	12g
Dimensions	-	14.22 x 13.21 mm

Recommended Operating Conditions

The Recommended Operating Conditions indicate the limits, inside which the device should be operated, to guarantee the performance given in Electrical Specifications. Operating outside these limits may not necessarily cause damage to the device, but the performance may degrade outside the limits of the electrical specifications. For limits, above which damage may occur, see Absolute Maximum Ratings.

Parameter	Min	Nominal	Max	Unit
Ambient Temperature	-55	25	100	°C
LO Input Power	7	-	15	dBm

Sequencing Requirements

There is no requirement to apply power to the ports in a specific order. However, it is recommended to provide a 50Ω termination to each port before applying power. This is a passive diode mixer that requires no DC bias.

Electrical Specifications

The electrical specifications apply at TA=+25°C in a 50Ω system. Typical data shown is for the connectorized S package mixer used in the forward direction with a +9 dBm sine wave input. Min and Max limits apply only to our connectorized units and are guaranteed at TA=+25°C. All bare die are 100% DC tested and visually inspected. RF testing of our die is performed on a sample basis to verify conformance to datasheet guaranteed specifications.

Parameter	Port Configuration	Test Conditions	Min	Typ	Max	Unit
Conversion Loss ¹	A	RF/LO = 9 - 44 GHz I = 4 - 14 GHz	-	9.5	-	dB
Conversion Loss ²	A	RF/LO = 9 - 44 GHz I = DC - 4 GHz	-	7.6	13.5	dB
Input 1 dB Gain Compression Point (P1dB)	A	-	-	5	-	dBm
Input IP3	A	RF/LO = 9 - 44 GHz I = DC - 0.2 GHz	-	12.5	-	dBm
Conversion Loss ³	B	RF/LO = 9 - 44 GHz I = 4 - 14 GHz	-	10	-	dB
Conversion Loss ⁴	B	RF/LO = 9 - 44 GHz I = DC - 4 GHz	-	8.6	14.5	dB
Input 1 dB Gain Compression Point (P1dB)	B	-	-	6	-	dBm
Input IP3	B	RF/LO = 9 - 44 GHz I = DC - 0.2 GHz	-	13.7	-	dBm
IF Frequency Range	-	-	0	-	14	GHz
Isolation, LO to IF	-	IF/LO = 9 - 44 GHz	-	49	-	dB
Isolation, LO to RF	-	RF/LO = 9 - 44 GHz	-	47	-	dB
Isolation, RF to IF	-	RF/IF = 9 - 44 GHz	-	39	-	dB
LO Frequency Range	-	-	10	-	44	GHz
Noise Figure ⁵	-	RF/LO = 9 - 44 GHz I = DC - 0.2 GHz	-	7.6	-	dB
RF Frequency Range	-	-	10	-	44	GHz

[1][2][3][4] Measured as a down converter to a fixed 91MHz IF.

[5] Mixer Noise Figure typically measures within 0.5 dB of conversion loss for IF frequencies greater than 5 MHz.

Typical Performance Plots

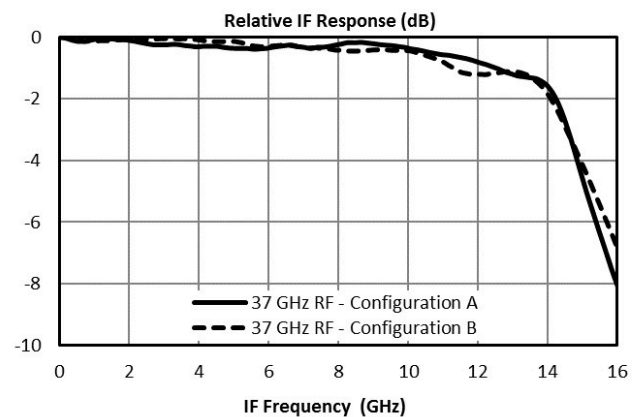
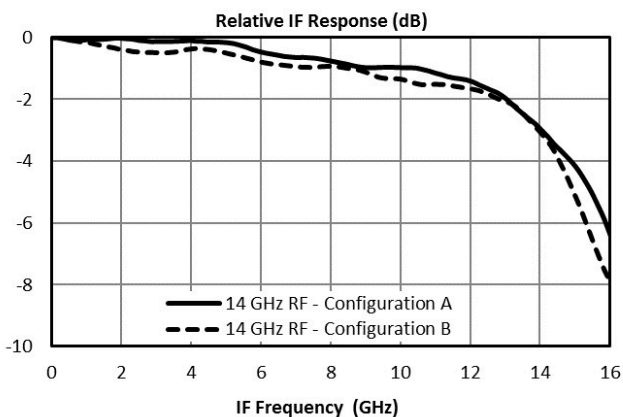
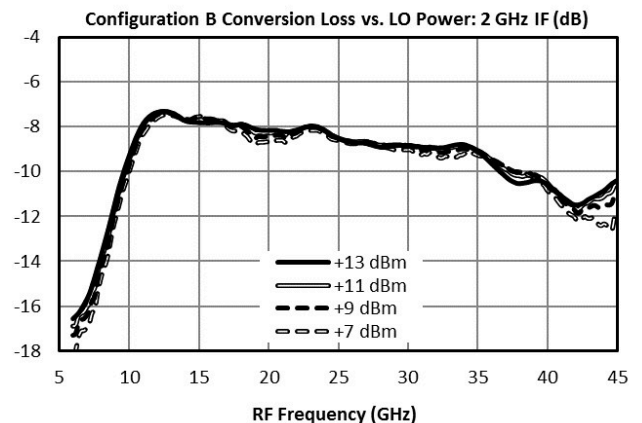
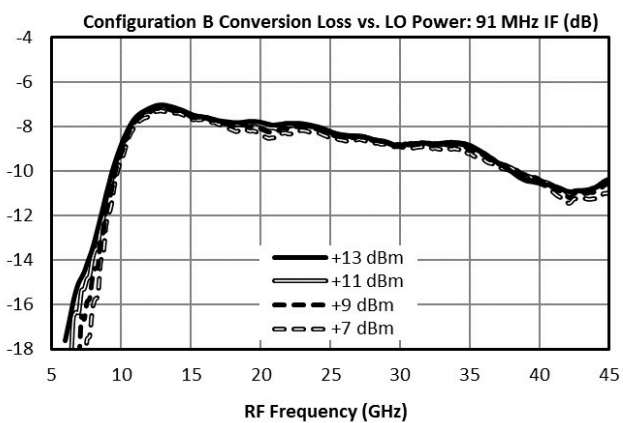
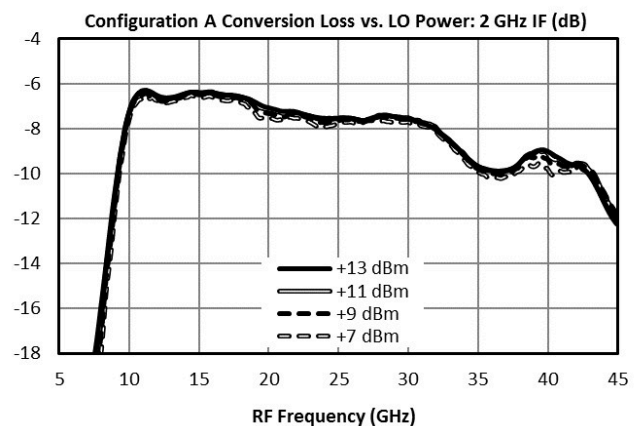
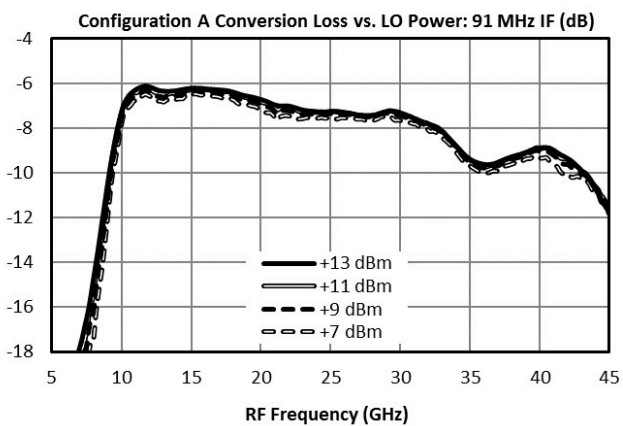
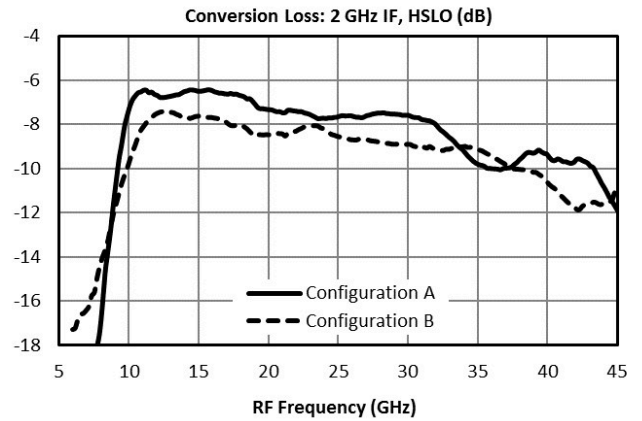
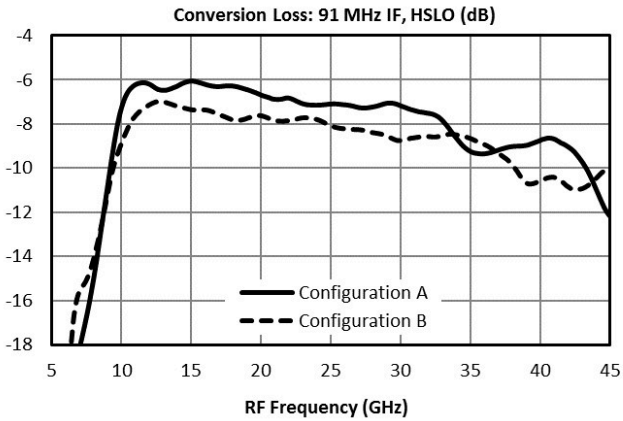

MM1-1044LS

Low Power GaAs MMIC Double Balanced Mixer

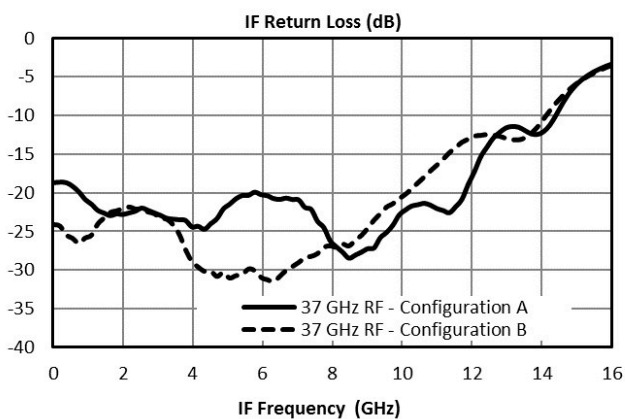
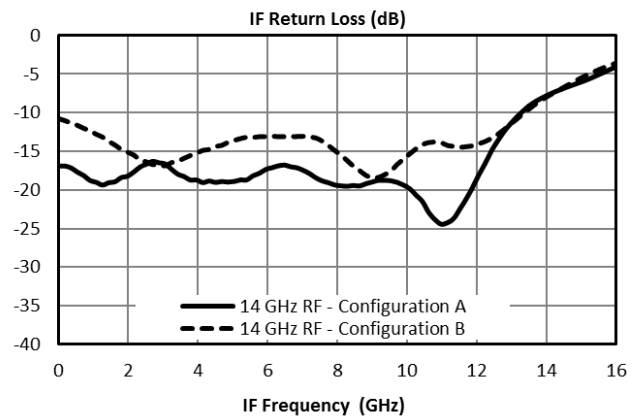
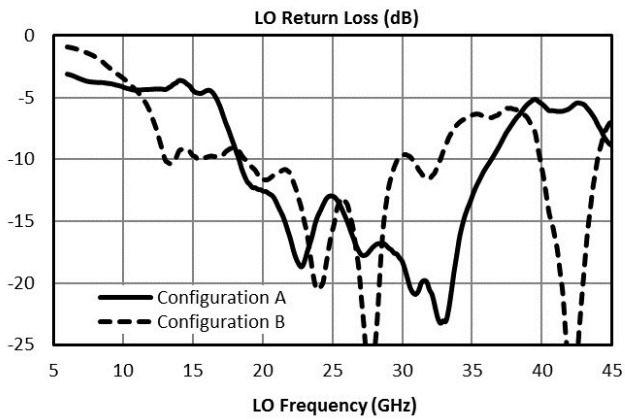
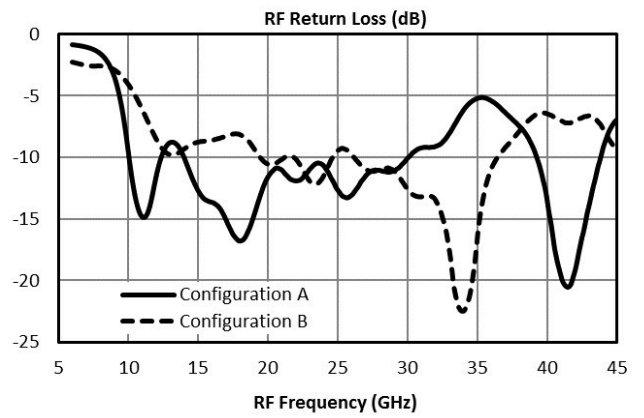
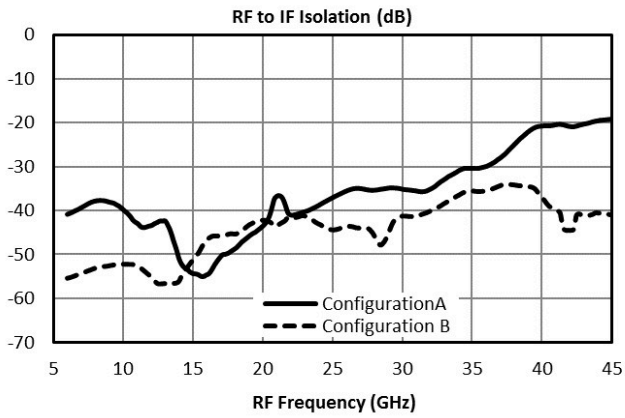
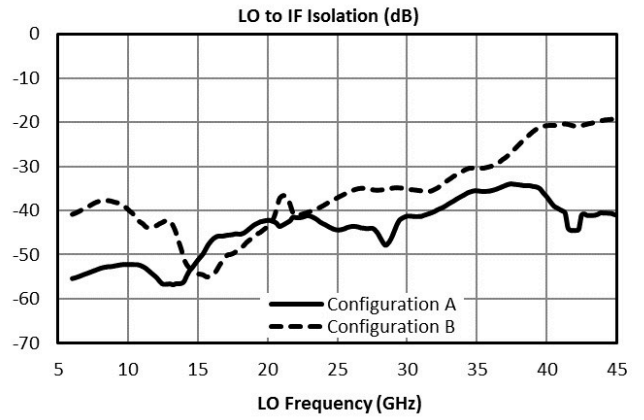
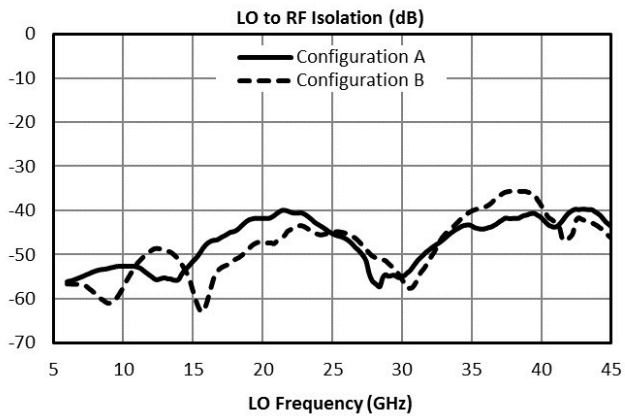

Typical Performance Plots: IP3

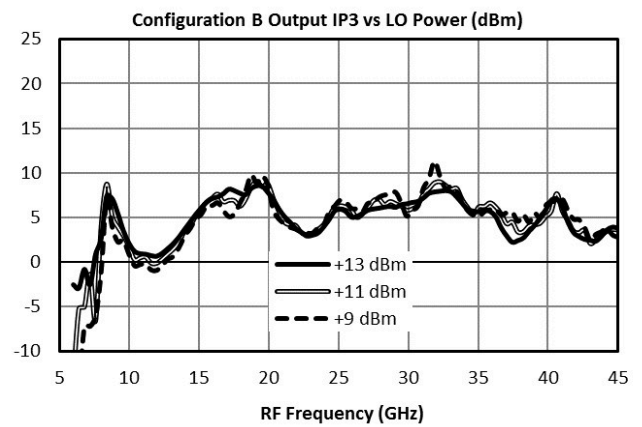
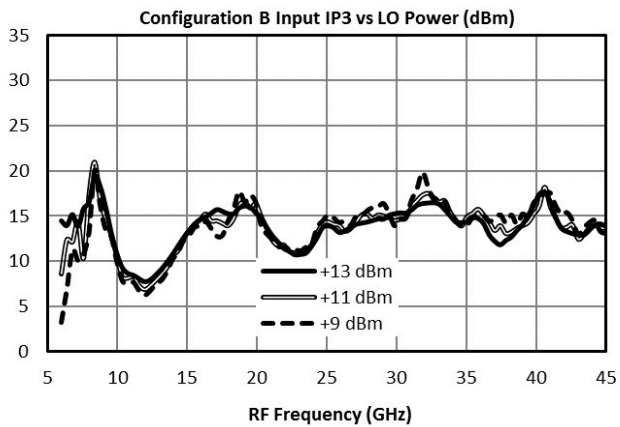
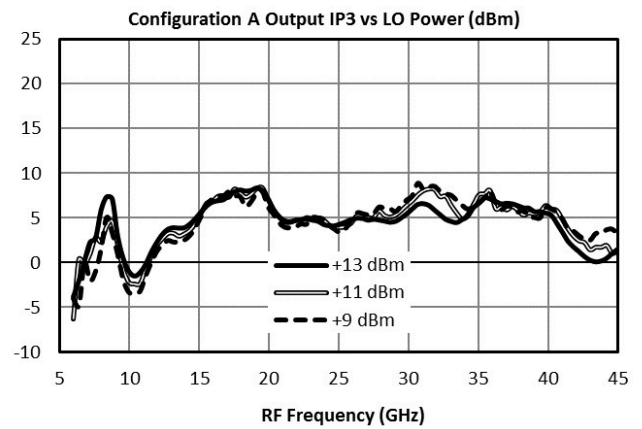
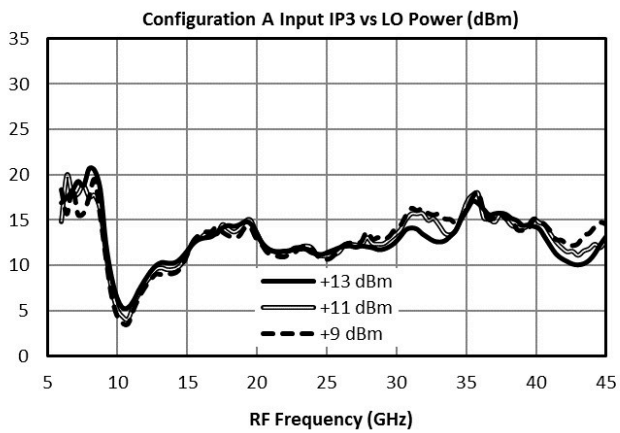
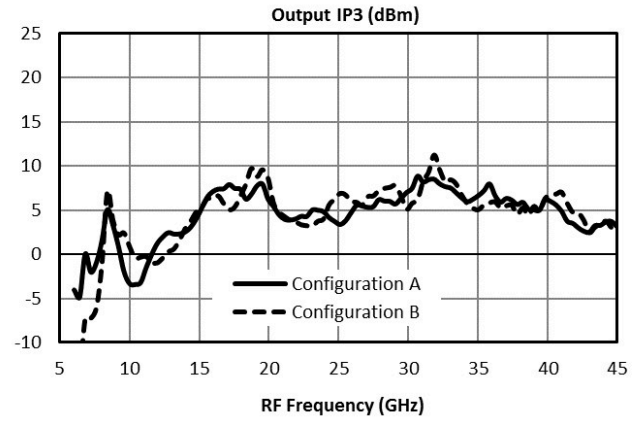
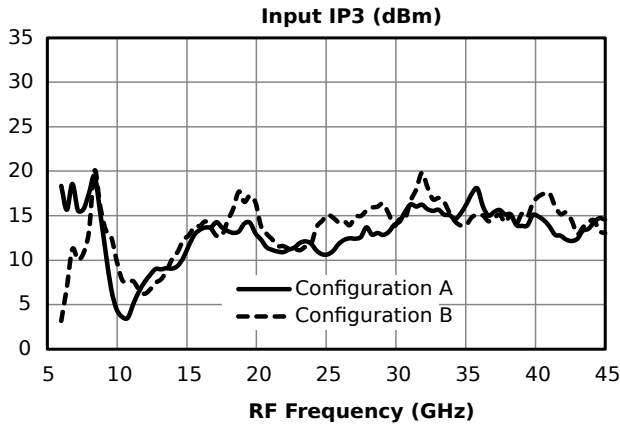

Typical Performance Plots: LO Harmonic Isolation

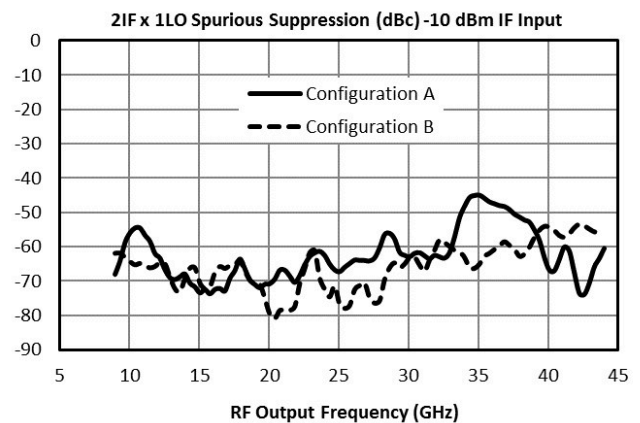
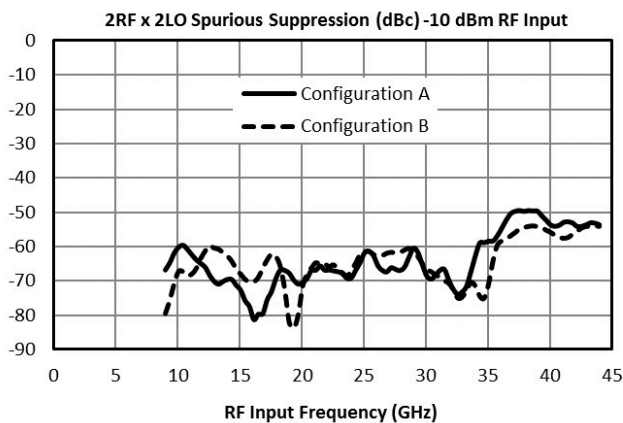
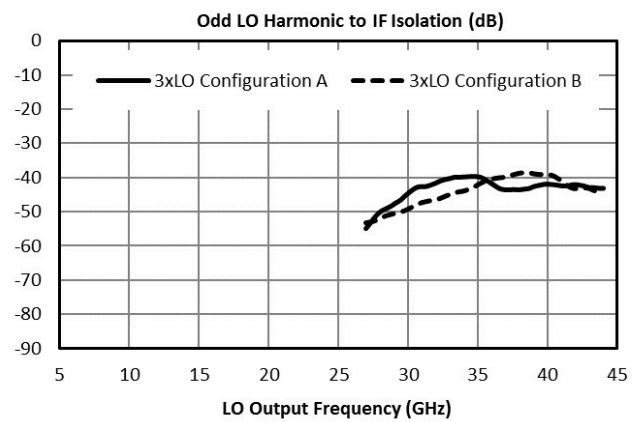
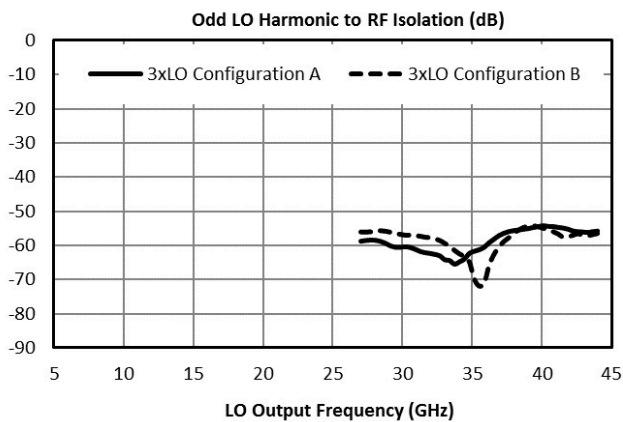
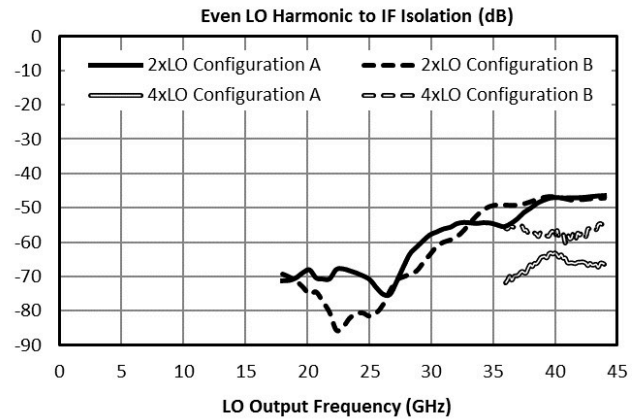
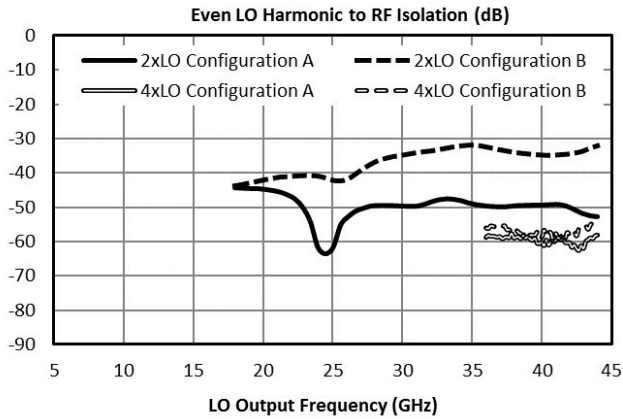

Spur Table

Typical Spurious Performance: Down-Conversion

Typical spurious data is provided by selecting RF and LO frequencies ($\pm m \cdot LO \pm n \cdot RF$) within the RF/LO bands, to create a spurious output within the IF band. The mixer is swept across the full spurious band and the mean is calculated. The numbers shown in the table below are for a -10 dBm RF input. Spurious suppression is scaled for different RF power levels by (n-1), where "n" is the RF spur order. For example, the 2RF x 2LO spur is 64 dBc for a -10 dBm input, so a -20 dBm RF input creates a spur that is (2-1) x (-10 dB) lower, or 74 dBc. Data is shown for the frequency plan in 3.6 Typical Performance.

Typical Down-conversion spurious suppression (dBc): Config A (B)

-10 dBm RF Input	0xLO	1xLO	2xLO	3xLO	4xLO	5xLO
1xRF	24 (21)	Reference	26 (40)	14 (14)	46 (40)	38 (32)
2xRF	74 (68)	52 (46)	64 (64)	61 (48)	68 (68)	59 (53)
3xRF	84 (83)	46 (49)	68 (82)	56 (58)	66 (79)	55 (56)
4xRF	107 (104)	92 (84)	93 (98)	93 (85)	100 (101)	97 (86)
5xRF	N/A	107 (103)	88 (105)	90 (94)	100 (114)	93 (96)

Typical Spurious Performance: Up-Conversion

Typical spurious data is taken by mixing an input within the IF band, with LO frequencies ($\pm m \cdot LO \pm n \cdot IF$), to create a spurious output within the RF output band. The mixer is swept across the full spurious output band and the mean is calculated. The numbers shown in the table below are for a -10 dBm IF input. Spurious suppression is scaled for different IF input power levels by (n-1), where “n” is the IF spur order. For example, the 2IFx1LO spur is typically 62 dBc for a -10 dBm input with a sine-wave LO, so a -20 dBm IF input creates a spur that is (2-1) x (-10 dB) lower, or 72 dBc. Data is shown for the frequency plan in 3.6 Typical Performance.

Typical Up-conversion spurious suppression (dBc): Config A (B)

-10 dBm RF Input	0xLO	1xLO	2xLO	3xLO	4xLO	5xLO
1xIF	24 (21)	Reference	28 (40)	15 (14)	46 (45)	20 (21)
2xIF	65 (58)	62 (66)	62 (46)	64 (69)	57 (49)	66 (75)
3xIF	73 (83)	53 (55)	61 (73)	50 (51)	62 (66)	58 (55)
4xIF	93 (90)	94 (99)	94 (84)	101 (99)	86 (86)	101 (103)
5xIF	116 (124)	87 (91)	99 (110)	84 (84)	101 (103)	81 (84)

MM1-1044LS

Low Power GaAs MMIC Double Balanced Mixer

Mechanical Data

Outline Drawing

Download : [Outline 2D Drawing](#) | [Outline 3D Drawing](#) | [Outline 3D STP](#)

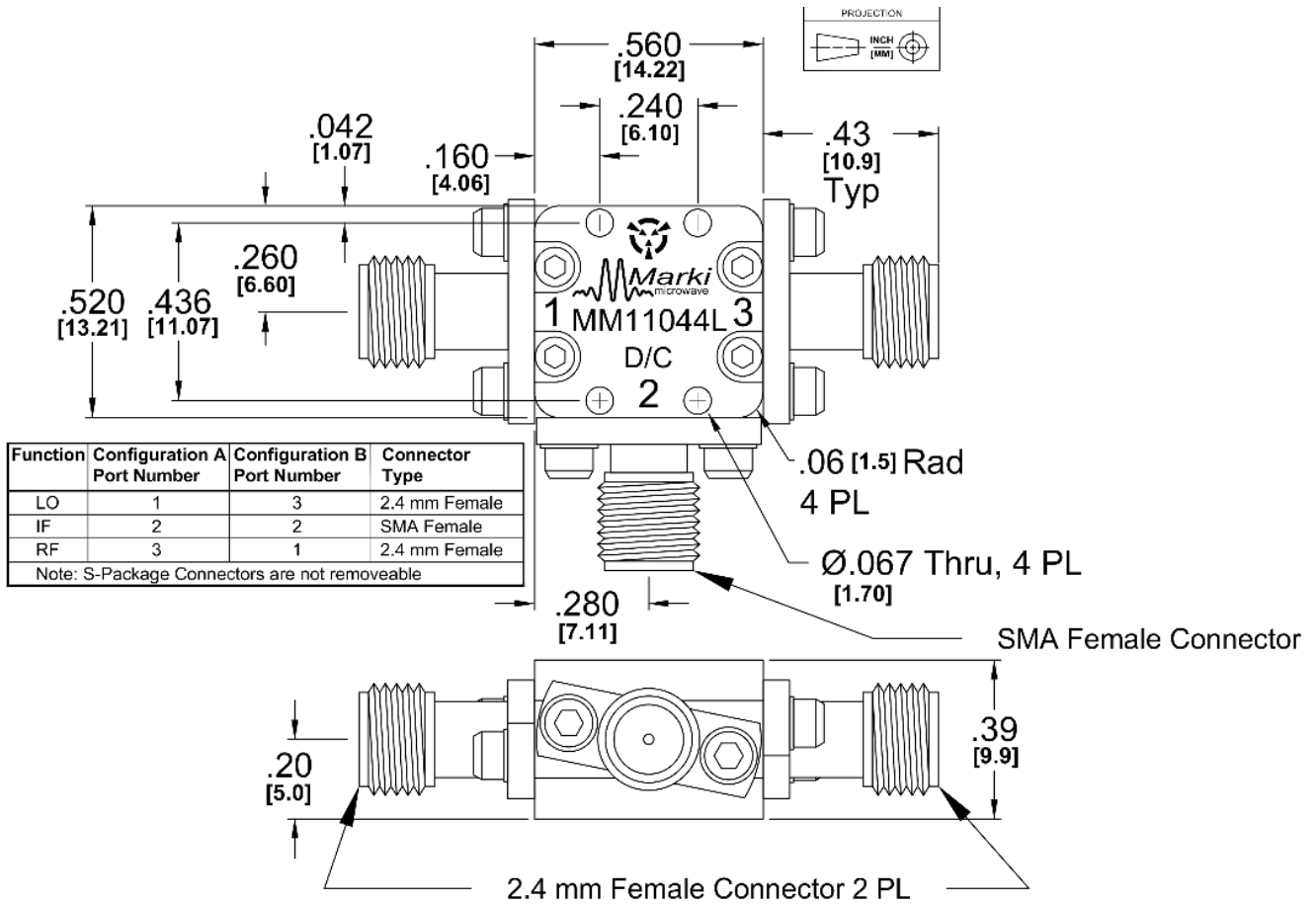

DISCLAIMER

MARKI MICROWAVE, INC., ("MARKI") PROVIDES TECHNICAL SPECIFICATIONS AND DATA (INCLUDING DATASHEETS), APPLICATION OR OTHER DESIGN ADVICE, WEB TOOLS, AND OTHER INFORMATION AND RESOURCES "AS IS" AND WITH ALL FAULTS. MARKI DISCLAIMS ALL WARRANTIES, EXPRESS OR IMPLIED, INCLUDING, WITHOUT LIMITATION, ANY IMPLIED WARRANTIES OF MERCHANTABILITY, FITNESS FOR A PARTICULAR PURPOSE, OR NON-INFRINGEMENT.

These resources are intended for developers skilled in the art designing with Marki products. You are solely responsible for (1) selecting the appropriate products for your application, (2) designing, validating, and testing your application, and (3) ensuring your application meets applicable standards and other requirements. Marki makes no guarantee regarding the suitability of its products for any particular purpose, nor does Marki assume any liability whatsoever arising out of your use or application of any Marki product.

Marki grants you permission to use these resources only for development of an application that uses Marki products. Other reproduction or use of these resources is strictly prohibited. No license is granted to any other Marki intellectual property or to any third-party intellectual property. Marki reserves the right to make changes to the product(s) or information contained herein without notice.

MARKI MICROWAVE and T3 MIXER are trademarks or registered trademarks of Marki Microwave, Inc. All other trademarks used are the property of their respective owners.

© 2018, 2020, Marki Microwave, Inc