

DPX-M50-1

Diplexer

DEVICE OVERVIEW

General Description

Available in either a connectorized or miniature surface mount package (0.240 inch x 0.150 inch), the DPX-M50 is a low cost, high performance diplexer. The unique design offers high pass/low pass signal routing/multiplexing with excellent isolation. Passband insertion loss is less than 1.2 dB with rejection typically exceeding 25 dB. Besides being ideal for transmitter/receiver applications, the DPX-M50 can also be used as an excellent non-reflective low pass (or high pass) filter for systems requiring broadband 50Ω impedance match (such as mixers).



[Download s-parameters here](#)

Features

- Low Insertion Loss
- Superior Repeatability
- Low Profile Miniaturized, Reflow Solderable Package Option
- User defined cross over frequencies available

Applications

- Reflectionless Filter Applications
- RF Transceivers

Functional Block Diagram

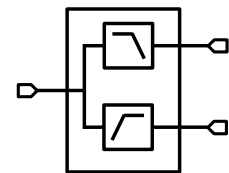

Part Ordering Options

Part Number	Description	Package	Green Status	Product Lifecycle	Export Classification
DPX-M50-1	Diplexer	DPX	RoHS REACH	Released	EAR99
<u>DPX-M50-2</u>	Diplexer	DPX	RoHS REACH	Released	EAR99

Table Of Contents

- **Device Overview**
 - General Description
 - Features
 - Applications
 - Functional Block Diagram
- **Port Configuration and Functions**
 - Port Diagram
 - Port Functions
- **Revision History**
- **Specifications**
 - Package Information
 - Electrical Specifications
 - Typical Performance Plots from DC - 1GHz
 - Typical Performance Plots from 1-10GHz
- **Mechanical Data**
 - Outline Drawing
- **Footprint Image**

Revision History

Revision Code	Revision Date	Comment
-	2013-01-01	Datasheet initial Release
A	2019-10-01	Maximum DC Voltage Rating Added

Port Configuration and Functions

Port Diagram

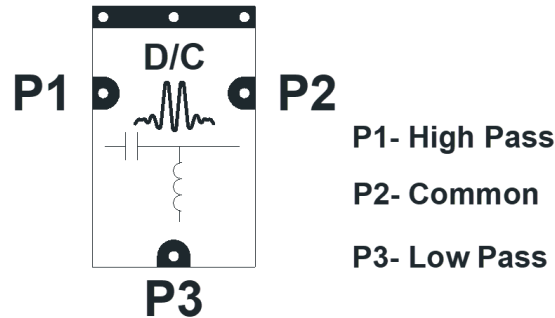

Port Functions

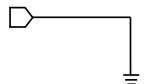
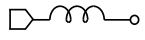
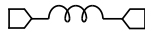
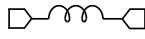
Port	Function	Description	Equivalent Circuit for Package
GND	Ground	DPX package ground is provided through the substrate and ground bond pads.	
Pin 1	High Pass Filter	Pin 1 is DC open to Pin 2 and Pin 3.	
Pin 2	Common/Input	Pin 2 is DC open to Pin 1 and short to Pin 3.	
Pin 3	Low Pass Filter	Pin 3 is DC open to Pin 1 and short to Pin 2.	

Specifications

Package Information

Parameter	Details	Rating
Dimensions	-	3.81 x 6.10 mm
Moisture Sensitivity Level	-	MSL 3

Electrical Specifications

Specifications guaranteed from -55 to +100°C, measured in a 50Ω system.

Parameter	Test Conditions	Minimum Frequency (GHz)	Maximum Frequency (GHz)	Min	Typ	Max	Unit
30 dBc Low Pass Rejection Point	<0.015 GHz	-	0.015	25	35	-	dB
30 dBc Low Pass Rejection Point	<0.035 GHz	-	0.035	-	20	-	dB
Common Port Return Loss	0.07 to 10 GHz	0.07	10	-	18	-	dB
Common Port Return Loss	DC to 0.035 GHz	0	0.035	-	18	-	dB
Cross Over Frequency	0.05 GHz	0.05	0.05	-	5	-	%
DC Voltage	-	-	-	-	-	25	V
High Frequency Passband	-	-	-	0.07	-	10	GHz
High Pass Filter, Pass Band Insertion Loss	0.07 - 10 GHz	0.07	10	-	0.7	1.4	dB
High Pass Filter, Pass Band Return Loss	0.07 - 10 GHz	0.07	10	-	18	-	dB
Isolation	<0.03 GHz	-	0.03	14	24	-	dB
Isolation	0.075 - 10 GHz	0.075	10	14	24	-	dB
Low Frequency Passband	-	-	-	0	-	0.035	GHz
Low Pass Filter, Pass Band Insertion Loss	DC to 0.035 GHz	0	0.035	-	0.7	1.4	dB
Low Pass Filter, Pass Band Return Loss	DC to 0.035 GHz	0	0.035	-	18	-	dB
Low Pass Filter, Stop Band Rejection	0.07 - 3 GHz	0.07	3	-	24	-	dB
Low Pass Filter, Stop Band Rejection	3 - 10 GHz	3	10	20	30	-	dB
RF Power	-	-	-	-	-	1	W

Typical Performance Plots from DC - 1GHz

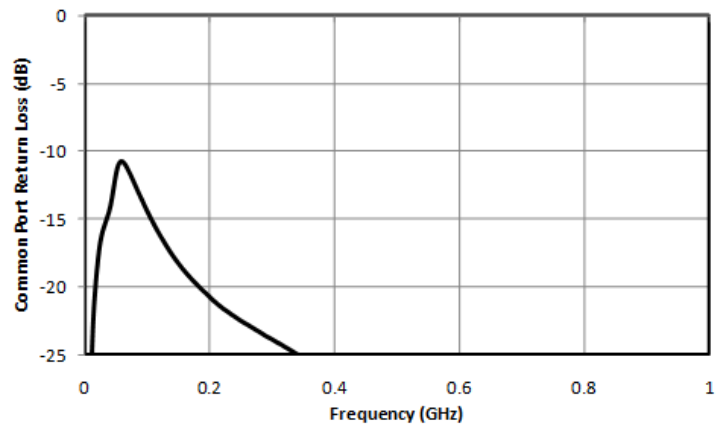
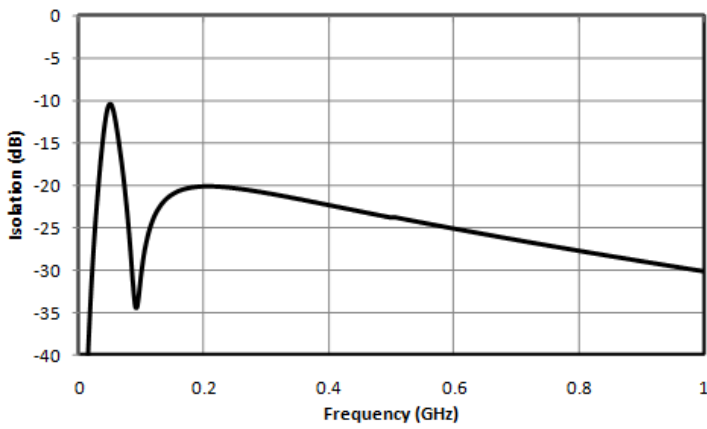
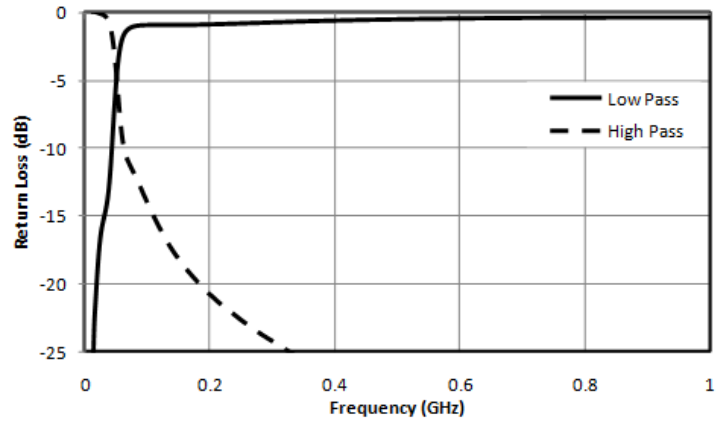
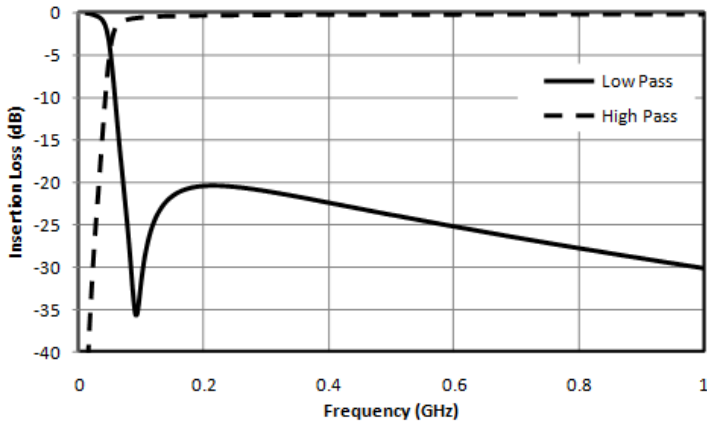

Typical Performance Plots from 1-10GHz

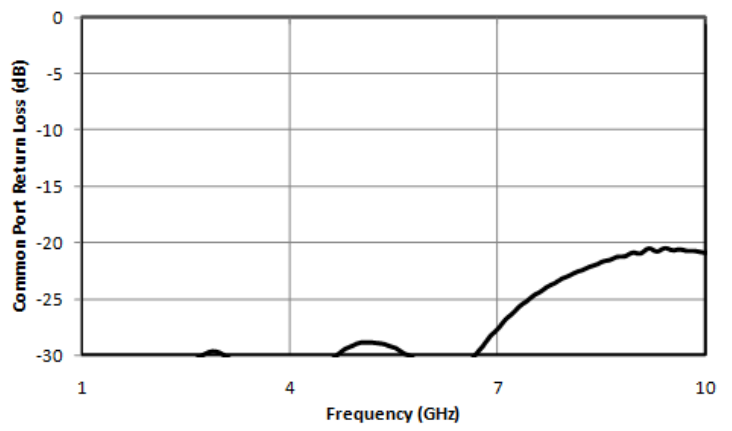
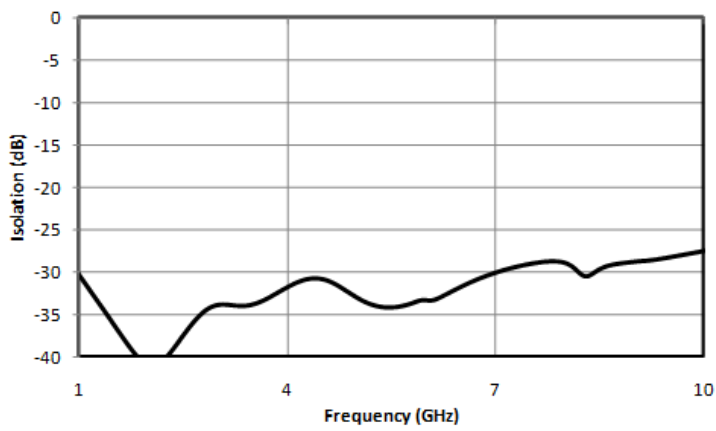
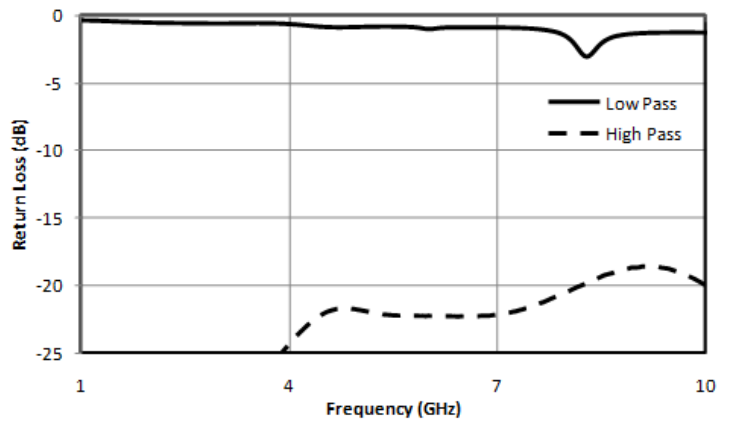
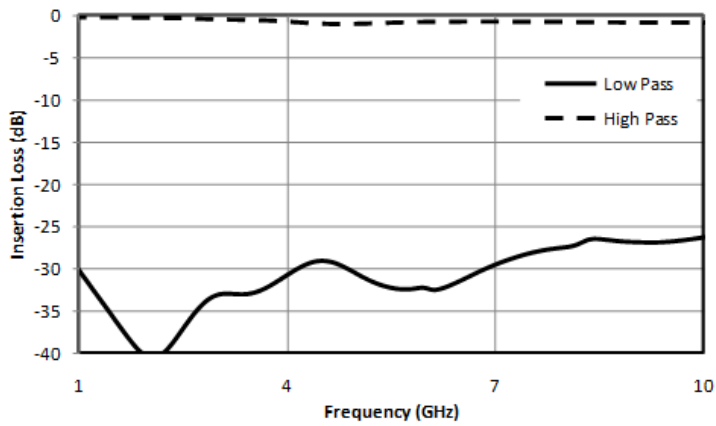

Mechanical Data

Outline Drawing

Download : [Outline 2D Drawing](#) | [Outline 3D Drawing](#) | [Outline 3D STP](#)

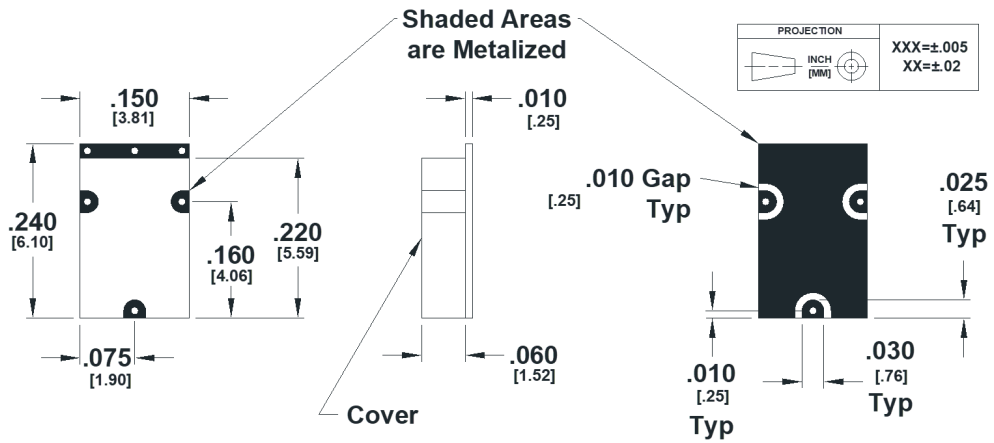

Footprint Image

Download: [Footprint Drawing](#)

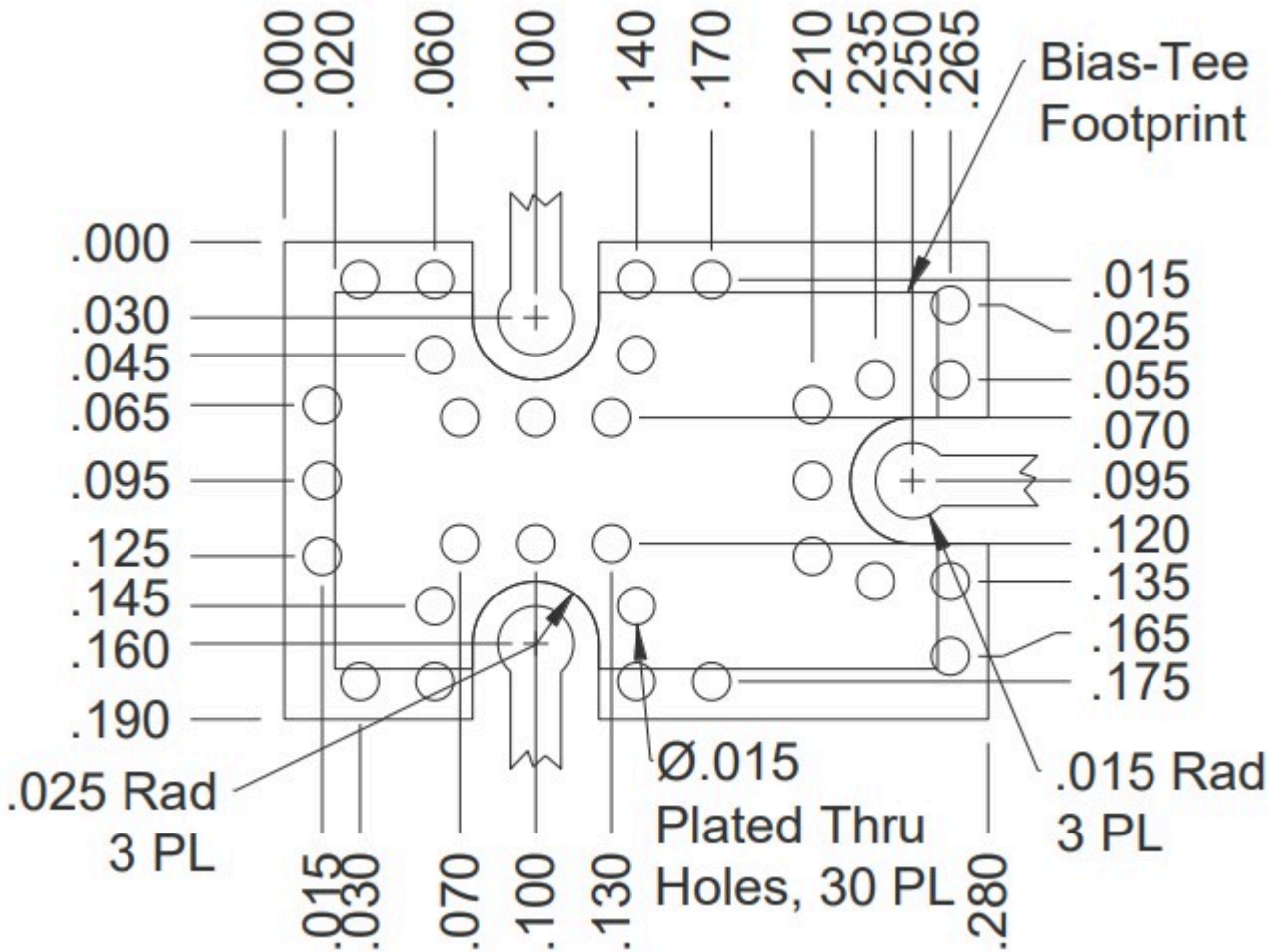

DISCLAIMER

MARKI MICROWAVE, INC., ("MARKI") PROVIDES TECHNICAL SPECIFICATIONS AND DATA (INCLUDING DATASHEETS), APPLICATION OR OTHER DESIGN ADVICE, WEB TOOLS, AND OTHER INFORMATION AND RESOURCES "AS IS" AND WITH ALL FAULTS. MARKI DISCLAIMS ALL WARRANTIES, EXPRESS OR IMPLIED, INCLUDING, WITHOUT LIMITATION, ANY IMPLIED WARRANTIES OF MERCHANTABILITY, FITNESS FOR A PARTICULAR PURPOSE, OR NON-INFRINGEMENT.

These resources are intended for developers skilled in the art designing with Marki products. You are solely responsible for (1) selecting the appropriate products for your application, (2) designing, validating, and testing your application, and (3) ensuring your application meets applicable standards and other requirements. Marki makes no guarantee regarding the suitability of its products for any particular purpose, nor does Marki assume any liability whatsoever arising out of your use or application of any Marki product.

Marki grants you permission to use these resources only for development of an application that uses Marki products. Other reproduction or use of these resources is strictly prohibited. No license is granted to any other Marki intellectual property or to any third-party intellectual property. Marki reserves the right to make changes to the product(s) or information contained herein without notice.

MARKI MICROWAVE and T3 MIXER are trademarks or registered trademarks of Marki Microwave, Inc. All other trademarks used are the property of their respective owners.

© 2013, 2019, Marki Microwave, Inc