

MMIQA-1040HPSM

Integrated Drive GaAs MMIC IQ Mixer

DEVICE OVERVIEW

General Description

The MMIQA-1040HPSM is a versatile, robust, and broadband IQ mixer with an integrated broadband LO driver amplifier. The MMIQA-1040HPSM is ideal for IQ, single sideband, and image reject mixing applications with wide bandwidths and operation at mmWave frequencies. The integrated LO driver amplifier allows for operation with LO powers as low as +0dBm while retaining exceptional conversion loss and linearity.

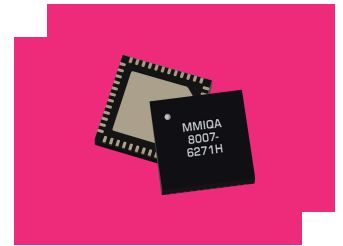

Features

RF/LO response: 10GHz - 40GHz
 IF response: DC – 10GHz
 I+Q Conversion Loss: 9 dB
 Image Rejection: 29dBc
 Minimum LO drive: +0dBm

Applications

- Single Sideband and Image Rejection Mixing
- IQ Modulation / Demodulation
- Vector Amplitude Modulation
- Band Shifting
- 5G Band Support

Functional Block Diagram

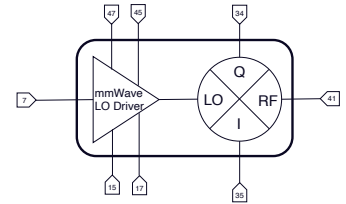

Part Ordering Options

Part Number	Description	Package	Packing Size	Green Status	Product Lifecycle	Export Classification
MMIQA-1040HPSM	Integrated Drive GaAs MMIC IQ Mixer	QFN	-	REACH RoHS	Released	EAR99
EVB-MMIQA-1040H	Integrated Drive GaAs MMIC IQ Mixer	EVB	-	RoHS REACH	Released	EAR99
MMIQA-1040HP-TR	Tape and Reel, Integrated Drive GaAs MMIC IQ Mixer	QFN	13"	REACH RoHS	Released	EAR99

Table Of Contents

- **Device Overview**
 - General Description
 - Features
 - Applications
 - Functional Block Diagram
- **Port Configuration and Functions**
 - Port Diagram
 - Port Functions
- **Revision History**
- **Specifications**
 - Absolute Maximum Ratings
 - Package Information
 - Recommended Operating Conditions
 - Sequencing Requirements
 - Electrical Specifications
 - Typical Performance Plots
 - Typical Performance Plots: IP3
 - Typical Performance Plots: Harmonic Leakage
 - Spur Tables
- **Operation**
 - Application Information
 - Application Circuit
 - Application Circuit Description
- **Mechanical Data**
 - Outline Drawing
- **Footprint Image**
- **Evaluation Board**
 - Evaluation Board Outline Drawing

Revision History

Revision Code	Revision Date	Comment
-	2023-11-27	Datasheet Initial Release
A	2024-11-21	Updated 2D outline drawing per ECN#24129. Corrected number of decimal places in dimensions.



Port Configuration and Functions

Port Diagram

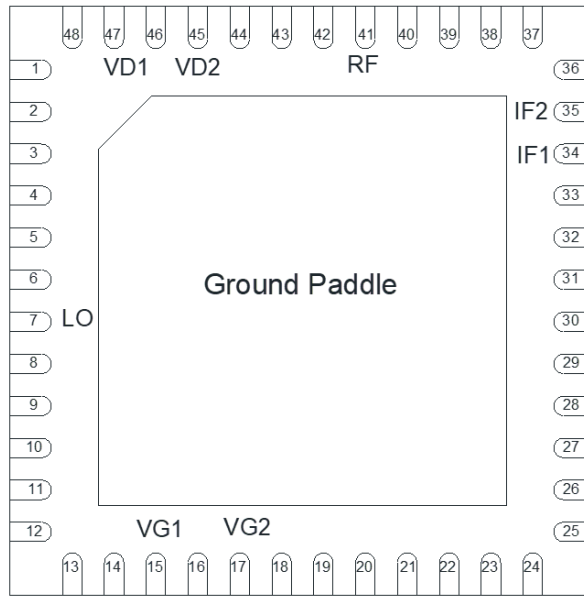
A top-down x-ray view of the MMIQA-1040HPSM's PSM package outline drawing is shown below. The MMIQA-1040HPSM has the input and output ports given in Port Functions.

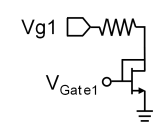
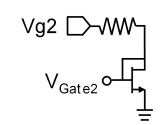
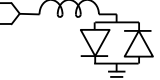

Port Functions

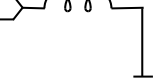
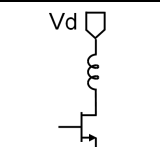
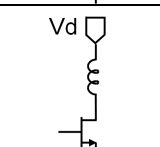
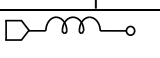
Port	Function	Description	Equivalent Circuit for Package
Pin 15	Vg1	Pin 15 provides bias for an internal current mirror that sets the current draw for amplifier input stage. Increasing current will increase gain at the expense of efficiency. The default series resistor (270 Ohms) is chosen to optimize gain, output power and efficiency when Vg1 and Vd1 are both tied to 5V.	
Pin 17	Vg2	Pin 17 provides bias for an internal current mirror that sets the current draw for amplifier output stage. Increasing current will increase gain at the expense of efficiency. The default series resistor (82.5 Ohms) is chosen to optimize gain, output power and efficiency when Vg2 and Vd2 are both tied to 5V.	
Pin 34	IF-1	Pin 34 is diode coupled and AC matched to 50Ω over the specified IF-1 port frequency range.	
Pin 35	IF-2	Pin 35 is diode coupled and AC matched to 50Ω over the specified IF-2 port frequency range.	
Pin 41	RF Input / Output	Pin 41 is DC short and AC matched to 50Ω over the specified RF frequency range.	
Pin 45	Vd2	Pin 45 is the DC supply pin for the amplifier's output stage.	
Pin 47	Vd1	Pin 47 is the DC supply pin for the amplifier's input stage.	
Pin 7	LO Input	Pin 7 is DC open and AC matched to 50Ω over the specified LO frequency range.	

Specifications

Absolute Maximum Ratings

The Absolute Maximum Ratings indicate limits beyond which damage may occur to the device. If any one of these limits are exceeded, the device may become inoperable or have a reduced lifetime. Reliability limits are individual, instantaneous catastrophic limits only. Functional operation limits are indicated below. Operation of the device at multiple absolute maximum limits or for extended periods at a single limit can cause degradation and damage to the device.

Parameter	Maximum Rating	Unit
Bias Current (I _{g1} +I _{g2})	95	mA
Bias Voltage (V _{g1} ,V _{g2})	6	V
Drain Current (I _{d1} +I _{d2})	400	mA
Drain Supply Voltage (V _{d1} ,V _{d2})	6	V
Maximum Operating Temperature	85	°C
Maximum Storage Temperature	125	°C
Minimum Operating Temperature	-40	°C
Minimum Storage Temperature	-65	°C
Pin 29 DC Current (IF1)	30	mA
Pin 30 DC Current (IF2)	30	mA
Power Handling, at any Port	15	dBm

Package Information

Parameter	Details	Rating
Dimensions	-	7x7 mm
Moisture Sensitivity Level	-	MSL 1

Recommended Operating Conditions

The Recommended Operating Conditions indicate the limits, inside which the device should be operated, to guarantee the performance given in Electrical Specifications. Operating outside these limits may not necessarily cause damage to the device, but the performance may degrade outside the limits of the electrical specifications. For limits, above which damage may occur, see Absolute Maximum Ratings.

Parameter	Min	Nominal	Max	Unit
Positive DC Voltage	-	5	-	V
LO Input Power	0	4	8	-

Sequencing Requirements

There is no sequencing required to power up or power down the mixer.

Electrical Specifications

The electrical specifications apply at TA=+25°C in a 50Ω system. Typical data shown is for a down conversion application with a +4dBm LO input to the integrated LO driver amp biased at +5Vd1/+5Vd2/+5Vg1/+5Vg2 unless otherwise specified.

Parameter	Test Conditions	Minimum Frequency (GHz)	Maximum Frequency (GHz)	Min	Typ	Max	Unit
Amplitude Balance	-	-	-	-	0.2	-	dB
Conversion Loss	RF/LO = 10 - 40 GHz I = 0.2 - 10 GHz	-	-	-	16	-	dB
Conversion Loss	RF/LO = 10 - 40 GHz I = DC - 0.2 GHz	-	-	-	12	-	dB
Conversion Loss	RF/LO = 10 - 40 GHz I+Q = DC - 0.2 GHz	-	-	-	9	-	dB
Conversion Loss	RF/LO = 10 - 40 GHz Q = 0.2 - 10 GHz	-	-	-	15	-	dB
Conversion Loss	RF/LO = 10 - 40 GHz Q = DC - 0.2 GHz	-	-	-	12	-	dB
I Frequency Range	-	-	-	0	-	10	GHz
Image Rejection	RF/LO = 10 - 40 GHz I+Q = DC - 0.2 GHz	-	-	-	29	-	dBc
Input IP3	RF/LO = 10 - 40 GHz I/Q = DC - 0.2GHz	-	-	-	26	-	dBm
Input P1dB, I	-	0	10	-	12	-	dBm
Input P1dB, Q	-	0	10	-	12	-	dBm
Isolation, RF to IF	RF/IF = 10 - 40 GHz	-	-	-	48	-	dB
LO Frequency Range	-	-	-	10	-	40	GHz
LO Leakage, LO to IF	IF/LO = 10 - 40 GHz	-	-	-	29	-	dBm
LO Leakage, LO to RF	RF/LO = 10 - 40 GHz	-	-	-	26	-	dBm
Noise Figure	RF/LO = 10 - 40 GHz I = DC - 0.2 GHz	-	-	-	12	-	dB
Noise Figure	RF/LO = 10 - 40 GHz Q = DC - 0.2 GHz	-	-	-	12	-	dB
Phase Balance	-	-	-	-	5	-	°
Q Frequency Range	-	-	-	0	-	10	GHz
RF Frequency Range	-	-	-	10	-	40	GHz

Eval board IF and RF traces were de-embedded using AFR and LO trace power correction was applied to show the true performance of the QFN. Measured as an I/Q down converter, unless otherwise stated Mixer Noise Figure typically measures within 0.5 dB of conversion loss for IF frequencies greater than 5 MHz. Image Rejection and Single sideband performance plots are defined by the upper sideband (USB) or lower sideband (LSB) with respect to the LO signal. Plots are defined by which sideband is selected by the external IF quadrature hybrid. Typical IIP3 is measured with I and Q ports combined with an external IF quadrature hybrid coupler.

Typical Performance Plots

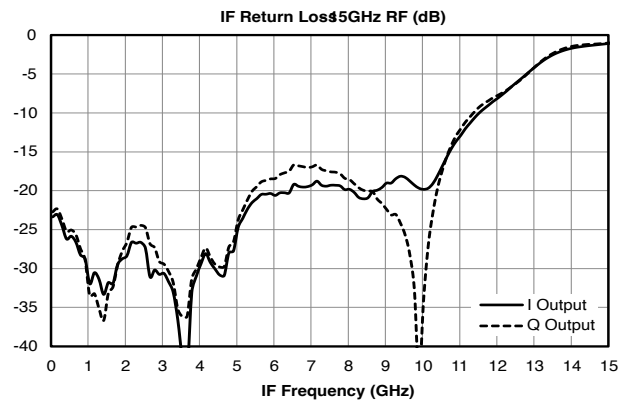
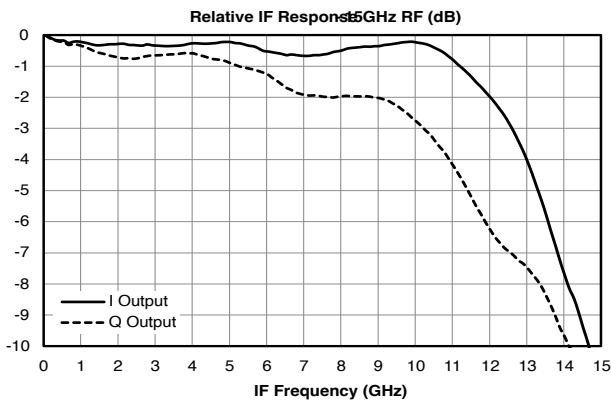
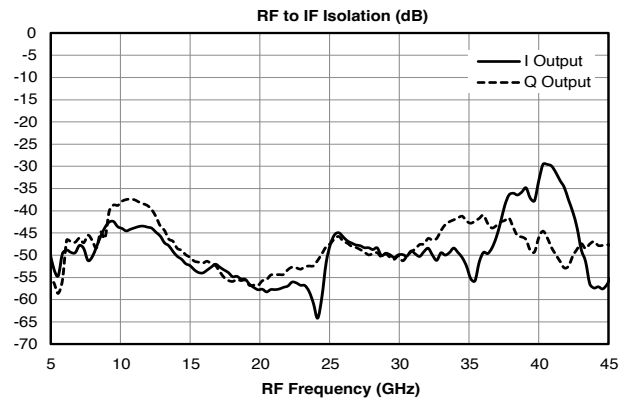
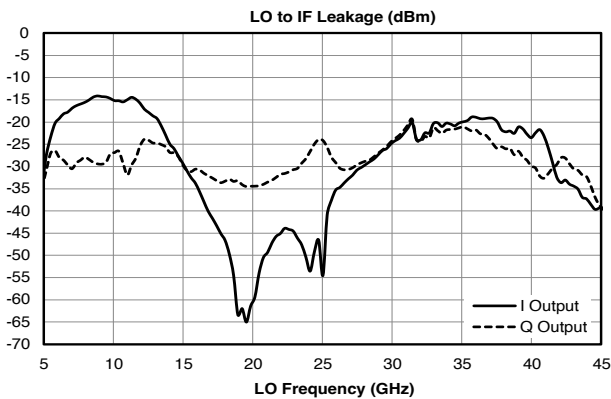
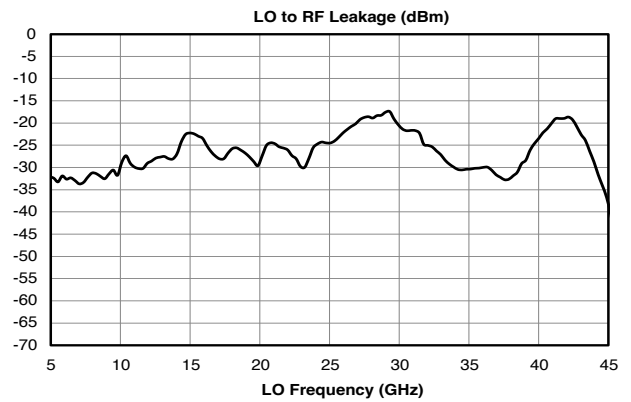
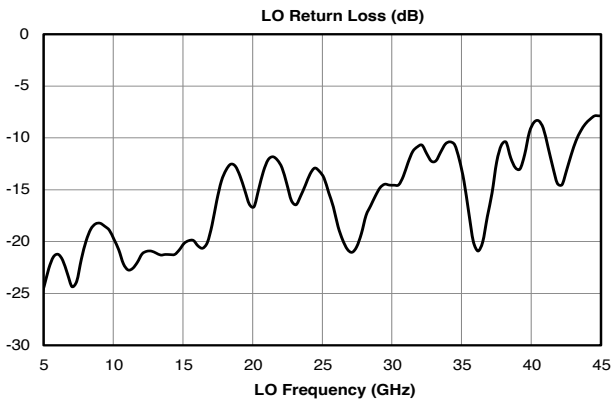
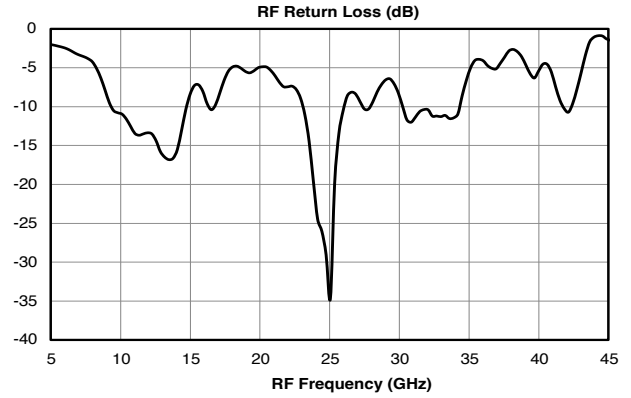
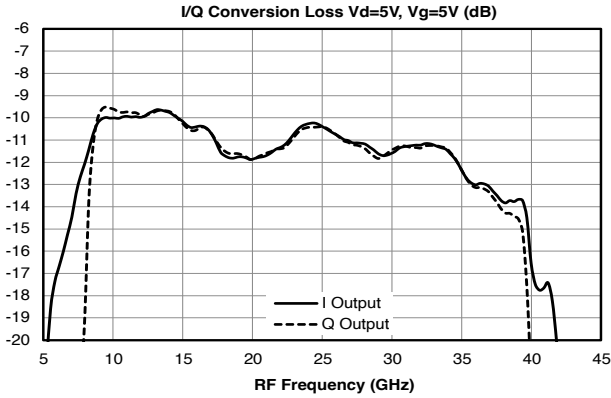

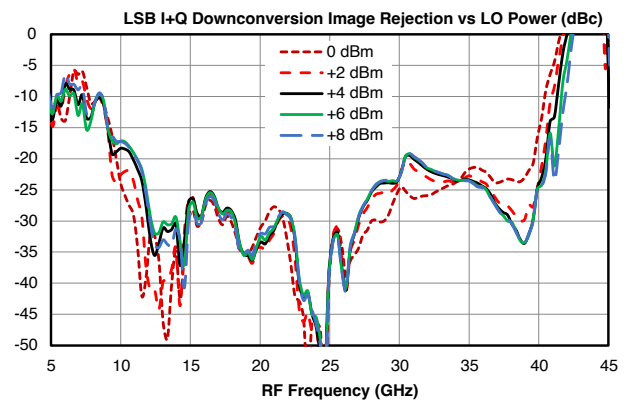
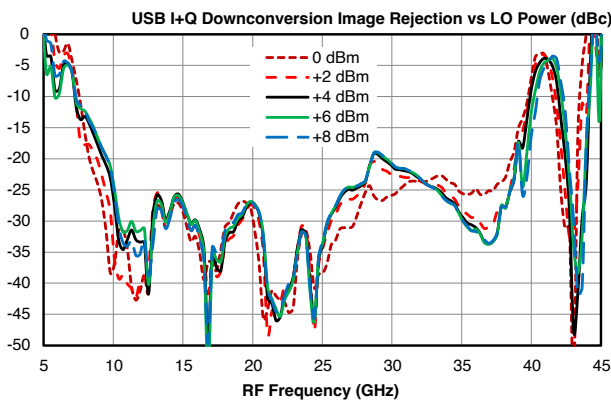
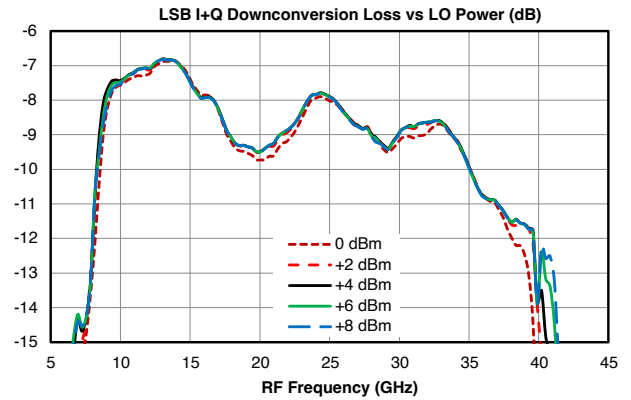
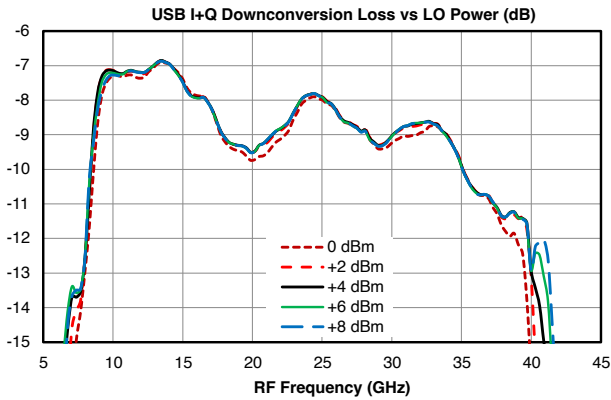
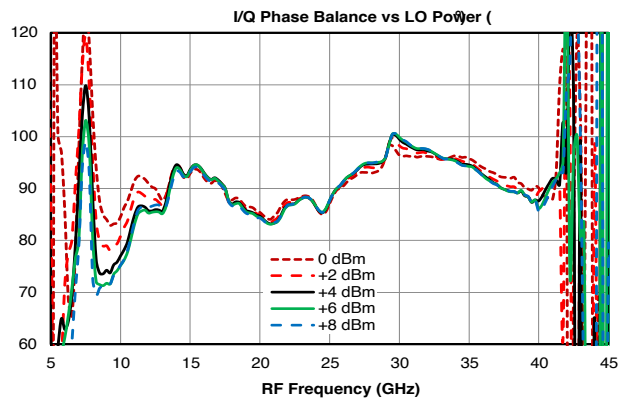
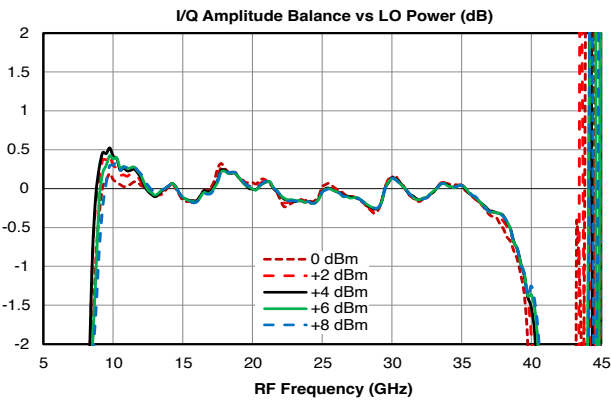
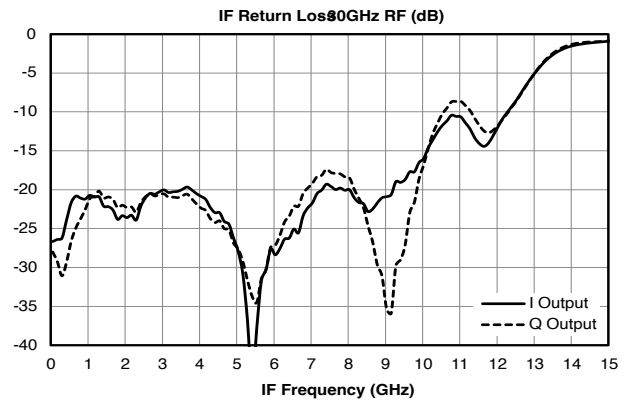
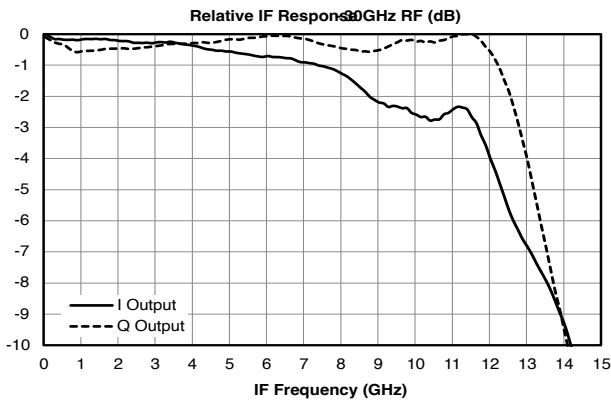

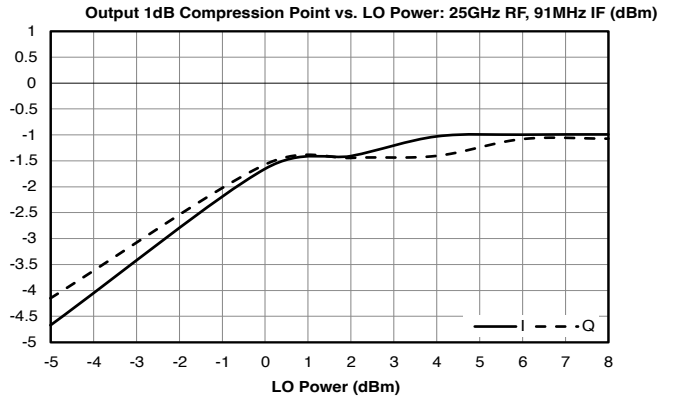
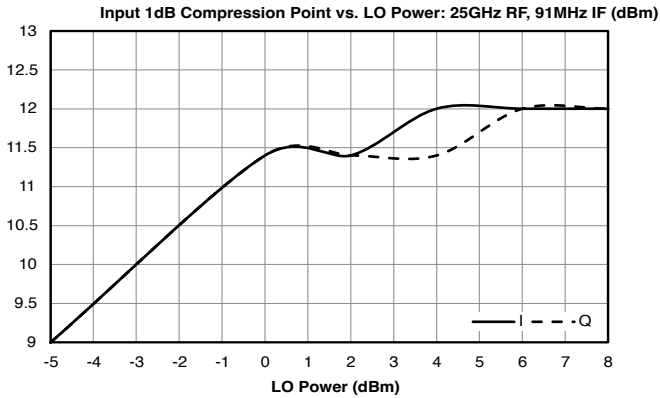
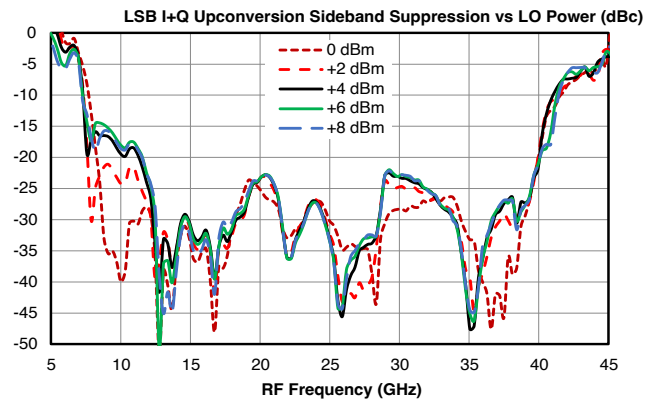
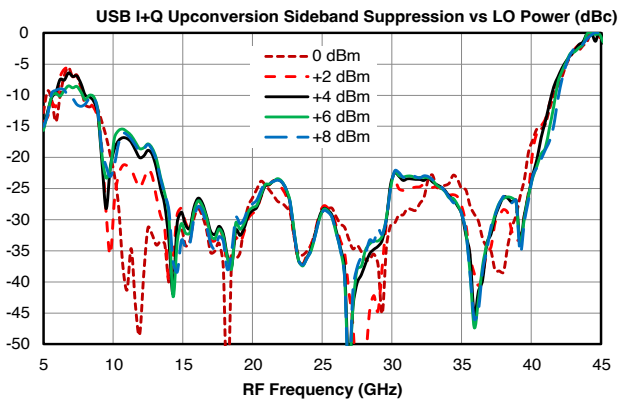
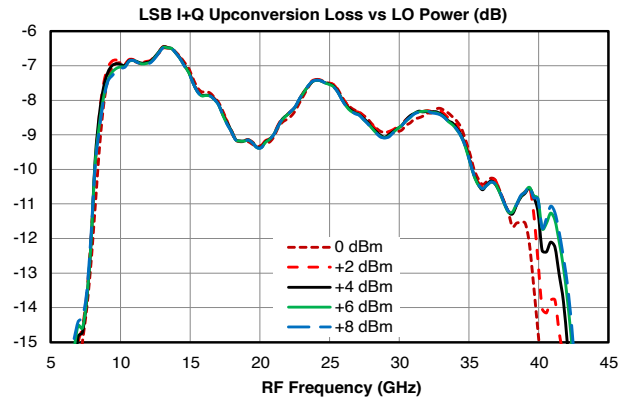
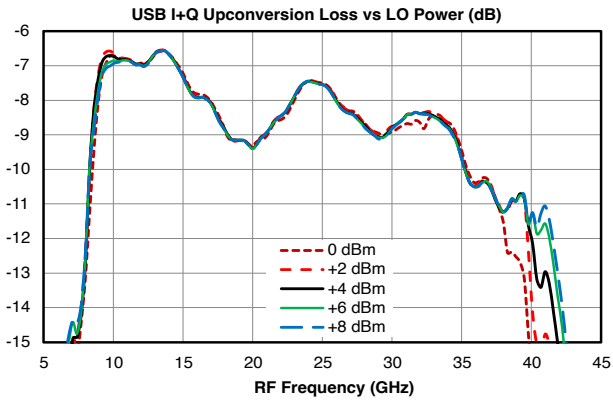

Typical Performance Plots: IP3

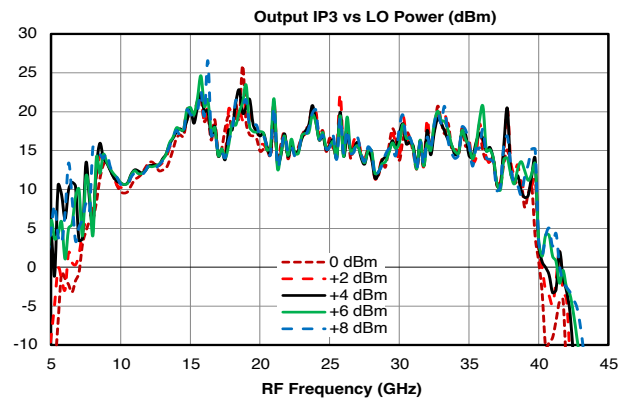
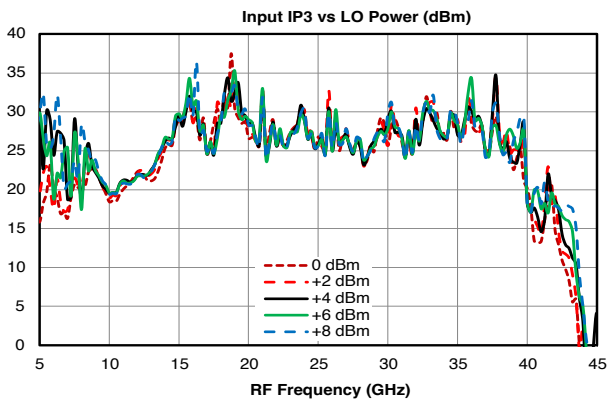
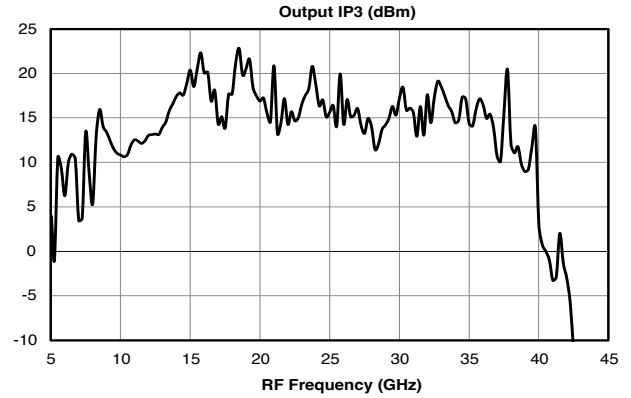
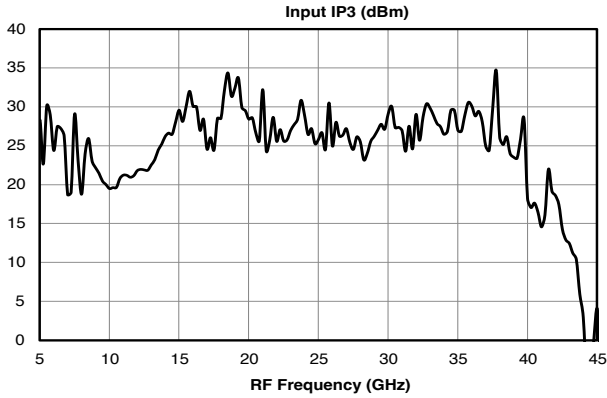

Typical Performance Plots: Harmonic Leakage

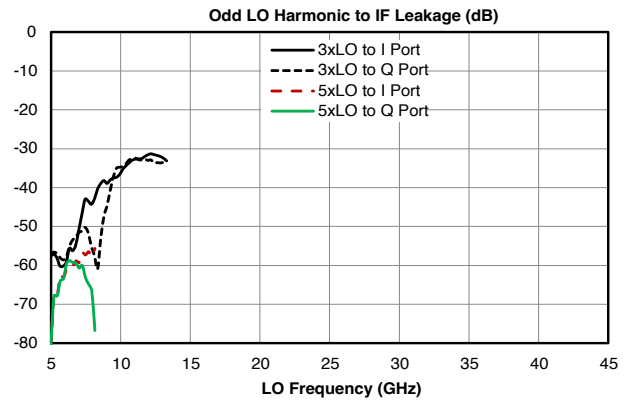
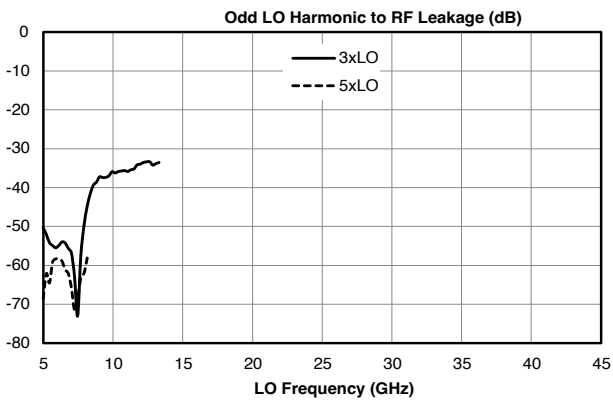
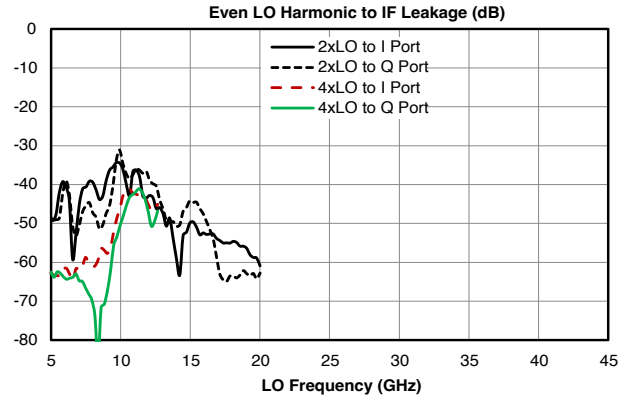
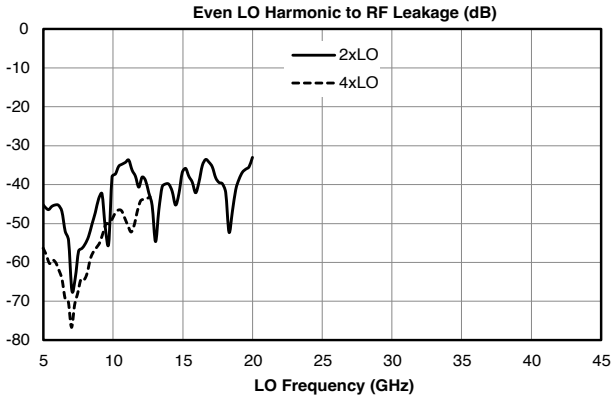

Spur Table

Typical Spurious Performance: Down-Conversion

Typical spurious data is provided by selecting RF and LO frequencies ($\pm m \cdot LO \pm n \cdot RF$) within the RF/LO bands, to create a spurious output within the IF band. The mixer is swept across the full spurious band and the mean is calculated. The numbers shown in the table below are for a -10 dBm RF input. Spurious suppression is scaled for different RF power levels by (n-1), where “n” is the RF spur order. For example, the 2RF x 2LO spur is 82 dBc for a -10 dBm input, so a -20 dBm RF input creates a spur that is (2-1) x (-10 dB) lower, or 92 dBc.

Typical Downconversion Spurious Suppression (dBc): I Port (Q Port)

-10 dBm RF Input	0xLO	1xLO	2xLO	3xLO	4xLO	5xLO
1xRF	N/A	Reference	33 (35)	15 (13)	29 (25)	N/A
2xRF	N/A	72 (71)	82 (80)	73 (75)	79 (84)	76 (79)
3xRF	N/A	89 (91)	95 (95)	95 (95)	95 (96)	94 (96)
4xRF	N/A	N/A	109 (107)	106 (108)	107 (106)	106 (105)
5xRF	N/A	N/A	116 (117)	117 (115)	116 (114)	114 (117)

Typical Spurious Performance: Up-Conversion

Typical spurious data is provided by selecting IF and LO frequencies ($\pm m \cdot LO \pm n \cdot IF$) within the IF/LO bands, to create a spurious output within the RF band. The mixer is swept across the full spurious band and the mean is calculated. The numbers shown in the table below are for a -10 dBm RF input. Spurious suppression is scaled for different IF power levels by (n-1), where “n” is the IF spur order. For example, the 2IF x 1LO spur is 77 dBc for a -10 dBm input, so a -20 dBm RF input creates a spur that is (2-1) x (-10 dB) lower, or 87dBc.

Typical Upconversion Spurious Suppression (dBc): I Port (Q Port)

-10 dBm IF Input	0xLO	1xLO	2xLO	3xLO	4xLO	5xLO
1xIF	N/A	Reference	31 (34)	13 (13)	31 (31)	N/A
2xIF	N/A	77 (78)	70 (69)	74 (74)	73 (72)	N/A
3xIF	N/A	90 (89)	88 (90)	83 (83)	87 (84)	N/A
4xIF	N/A	104 (108)	101 (101)	95 (95)	96 (92)	N/A
5xIF	N/A	115 (113)	110 (109)	106 (104)	103 (104)	107 (105)

Application Information

MMIQA-1040 belongs to Marki Microwave’s MMIQ family of mixers with integrated LO drivers. The MMIQ product line consists of passive GaAs MMIC mixers designed and fabricated with GaAs Schottky diodes. MMIQ mixers offer excellent amplitude and phase balance due to its on-chip LO quadrature hybrid. 29 dB of image rejection (i.e., single sideband suppression) can be obtained across the operating band by using the MMIQ-1040 as an image rejection or single sideband mixer. The MMIQA-1040HPSM is the sister mixer of the MMIQ-1040HSM. The MMIQA-1040HPSM requires a lower LO drive to operate the mixer thanks to the integrated LO driver amplifier.

Band support for the low frequency 5G frequencies in K and Ka bands is offered by the ultra-broadband performance of the mixer’s RF and LO ports (ports 41 and 7). Direct baseband to Ka band frequency conversions are available by using of this mixer as an up-converter. Traditional use of this mixer to do image reject or single sideband mixing is available with an external IF quadrature hybrid.

Pin 41, the RF port, and Pin 7, the LO port, supports a 10-40 GHz signal. Pins 34 and 35, the I and Q ports, support a DC-10 GHz signal. A signal may be input into any port of the mixer which supports that signal’s frequency. This is the basis of using the mixer as a band shifter.

For a given LO power within the recommended operating range, the RF (in the case of a down conversion) or IF (in the case of an up conversion) input power should be below the input 1 dB compression point to avoid signal distortion. The input 1 dB compression point will vary across the mixer’s operating bandwidth and with LO input power. Careful characterization is required for optimal performance for each application. There is no minimum small signal input power required for operation. Excessive RF/IF input power increases non-desired spurious output power and degrades the fundamental conversion loss. Excessive LO input power can also cause this effect. The table below describes how to use an IQ mixer and quad hybrid to select a single sideband.

Up Conversion		
Hybrid Port	Mixer Port	Sideband Selected
0	I	Lower Sideband
90	Q	
90	I	Upper Sideband
0	Q	
Down Conversion		
Hybrid Port	Mixer Port	Sideband Selected
0	I	Upper Sideband
90	Q	
90	I	Lower Sideband
0	Q	

Down-Converter

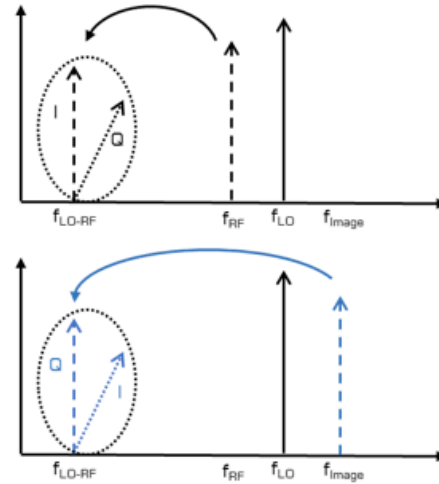
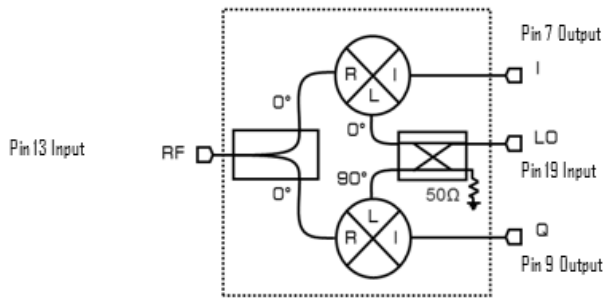

A down converter is a mixer application which takes a high frequency small signal RF input, and a high frequency large signal LO input and mixes the signals together to produce a low frequency IF output. The fundamental $1RF \times 1LO$ outputs present at the IF port are the f_{LO-RF} and f_{LO+RF} tones. The desired output in a down conversion is typically the f_{LO-RF} term. An image frequency at $f_{Image} = f_{2LO-RF}$ will also down convert to the f_{LO-RF} frequency. The above illustration shows the relative location of the image frequency for a highside LO, or the frequency plan for which $f_{LO} > f_{RF}$.

To use the IQ mixer as a down converter, input a high frequency small signal RF input into pin 41, a LO input into pin 7, and pull the low frequency IF output from pins 34 and 35. Pins 34 and 35 will output the IF signals I and Q. I and Q IF outputs will be at the same frequency but 90° out of phase (i.e., I and Q are in quadrature). If only a single IF output is desired, terminate either the I or Q ports with a wideband 50Ω load.

This is the input scheme was used to take I/Q down-conversion datafound in the Typical Performance Plots section.

Image Reject Down-Converter

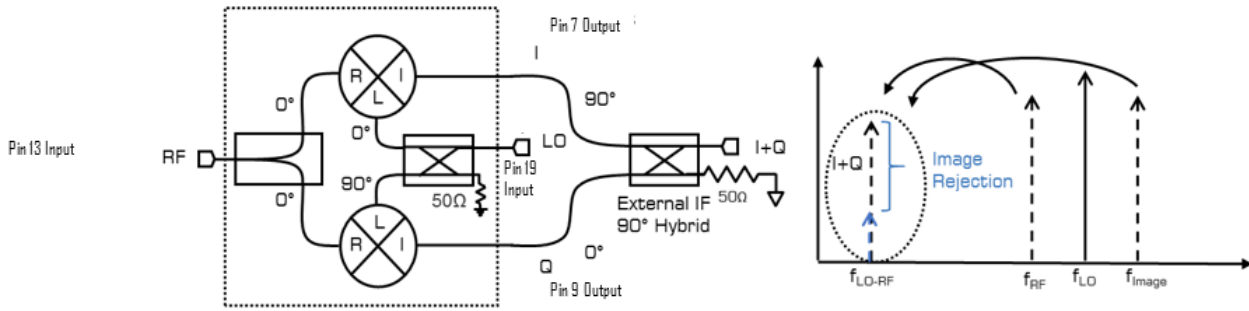

An image reject mixer is a mixer which rejects the down converted image frequency from the IF output. Image reject mixers are constructed using an external quadrature hybrid attached to the I and Q (i.e., IF) output ports of an IQ mixer. Using the external IF quadrature hybrid, one can select whether the upper sideband or lower sideband signal is suppressed with respect to the LO signal.

To use the IQ mixer as an image reject mixer, input the high frequency small signal RF into pin 41 and a LO input into pin 7. Take the combined I+Q down converted signal through the IF quadrature hybrid. Select the upper sideband (i.e., suppress the lower sideband) by connecting the I port to the 0° port of the IF quadrature hybrid and attach the Q port to the 90° port of the IF quadrature hybrid. Select the lower sideband (i.e., suppress the upper sideband) by attaching the I port to the 90° port of the IF quadrature hybrid and attach the Q port to the 0° port of the IF quadrature hybrid.

This is the input scheme was used to take I/Q down-conversion data found in the Typical Performance Plots section.

Up-Converter

This is the input scheme used to take I/Q up-conversion data found in the Typical Performance Plots section.

Single Sideband Up-Converter

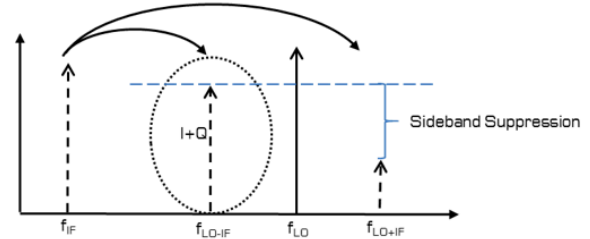
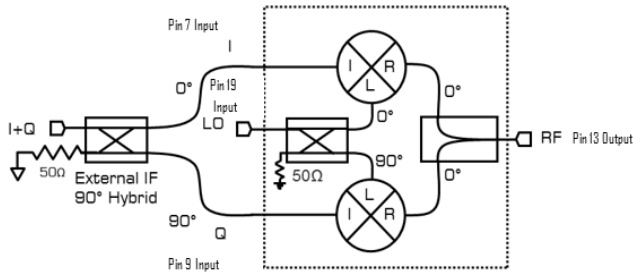

A single sideband mixer is a mixer which suppresses the up converted image frequency from the RF output. Single sideband mixers are constructed using an external quadrature hybrid attached to the I and Q (i.e., IF) input ports. Using an external IF quadrature hybrid, one can select whether the upper sideband or the lower sideband signal is suppressed with respect to the LO signal.

To use the IQ mixer as a single sideband mixer, input the low frequency small signal I+Q IF signal into the IF quadrature hybrid. The IF quadrature hybrid is attached to the I and Q ports of the IQ mixer. Input the LO input into pin 7 and take the up converted high frequency RF signal from pin 41. Select the upper sideband (i.e., suppress the lower sideband) by attaching the I port to the 90° port of the IF quadrature hybrid and attach the Q port to the 0° port of the IF quadrature hybrid. Select the lower sideband (i.e., suppress the upper sideband) by attaching the I port to the 0° port of the IF quadrature hybrid and attach the Q port to the 90° port of the IF quadrature hybrid.

Band Shifter

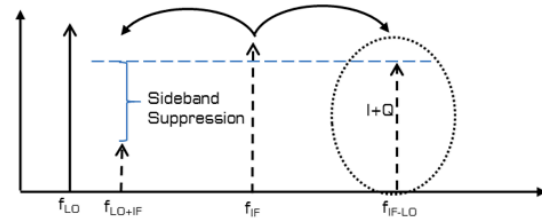
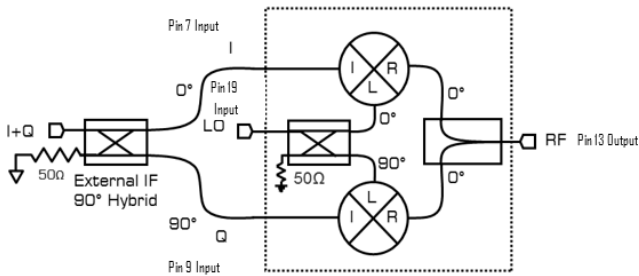

A band shifter is an unusual application for a mixer. Band shifters take an IF signal and shift it to a different band, generally to either avoid interference or for rebroadcast at a different frequency. For cases in which the desired band shift cannot be employed by using a standard up or down conversion scheme, an exotic input scheme is required.

A passive diode mixer is reciprocal on all ports. Pin 41, the RF port, supports a 10-40GHz signal. Pin 7, the LO port, supports a 10-40GHz signal. Pins 34 and 35, the IF ports, support a DC-10GHz signal. 2 signals input into any combination of the 3 ports, RF, LO, or IF, will result in an output signal at the 3rd port. In addition, an output signal will be present at both input ports. By using the IF port, as a large signal input port, low frequency LO applications can be supported.

The diagram above shows an IQ mixer being used as a band shifter. Using an IQ mixer as a band shifter allows for sideband suppression. This is identical to using the IQ mixer as a single sideband up converter. However, the large signal input port is now pin 34 + pin 35 versus pin 7. Selection of the output tone is done through the orientation of the LO quadrature hybrid.

To use the mixer as a single sideband band shifter, input a low frequency LO into the external LO quadrature hybrid. Input the high frequency small signal IF signal into Pin 7 and take the high frequency RF output from pin 41. Select the upper sideband (i.e., suppress the lower sideband) by connecting the I port to the 90° port of the IF quadrature hybrid and connect the Q port to the 0° port of the LO quadrature hybrid. Select the lower sideband (i.e., suppress the upper sideband) by connecting the I port to the 0° port of the LO quadrature hybrid and connect the Q port to the 90° port of the LO quadrature hybrid.

This is the measurement scheme used to take vector modulator data found in the Typical Performance Plots: Vector Modulator section.

Using this input scheme requires careful accounting of which input signal is injecting which port. Injecting a signal into any port which does not support the correct band will lead to a degraded or no output response. Abide by the maximum DC current input into the I and Q ports of the mixer or otherwise irreversible damage to the mixer will occur.

The limitation in use of the mixer as an image reject band shifter is in the bandwidth of the external LO quadrature hybrid and bandwidth of the I and Q ports.

Application Circuit

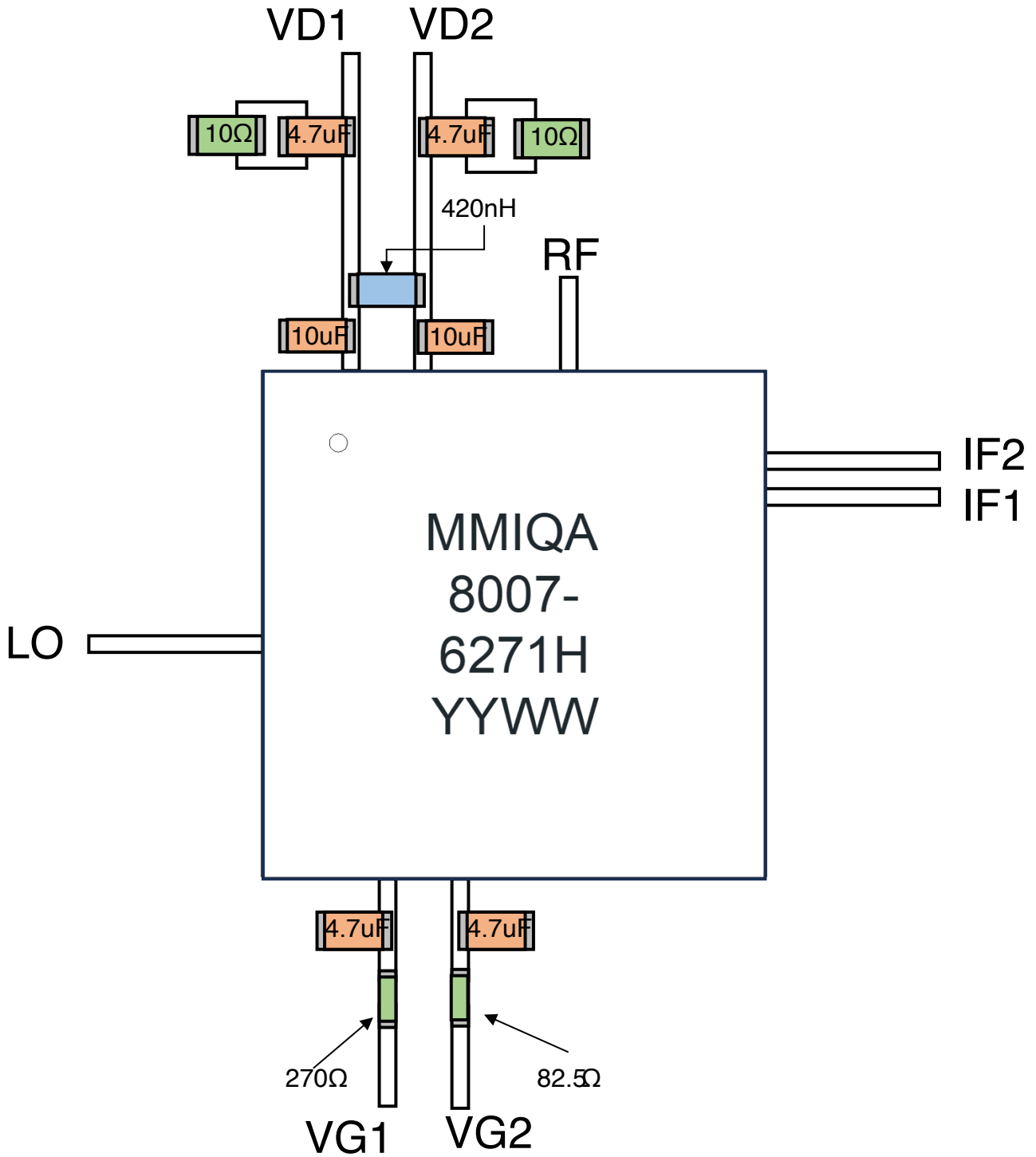

Application Circuit Description

The application circuit for the MMIQA-1040HPSM requires 10 μ F bypass capacitors on the drain lines near the QFN. A 420nH inductor is needed between the VD lines to provide isolation as well as an RC network to ground comprised of a 4.7 μ F capacitor and 10 Ω resistor. The VG lines require 4.7 μ F bypass capacitors and series resistors of 270 Ω in line with the VG supply. The current evaluation circuit is configured for single supply operation, but can be operated as dual supply by removing the 420nH inductor.

Mechanical Data

Outline Drawing

Download : [Outline 2D Drawing](#) | [Outline 3D STP](#)

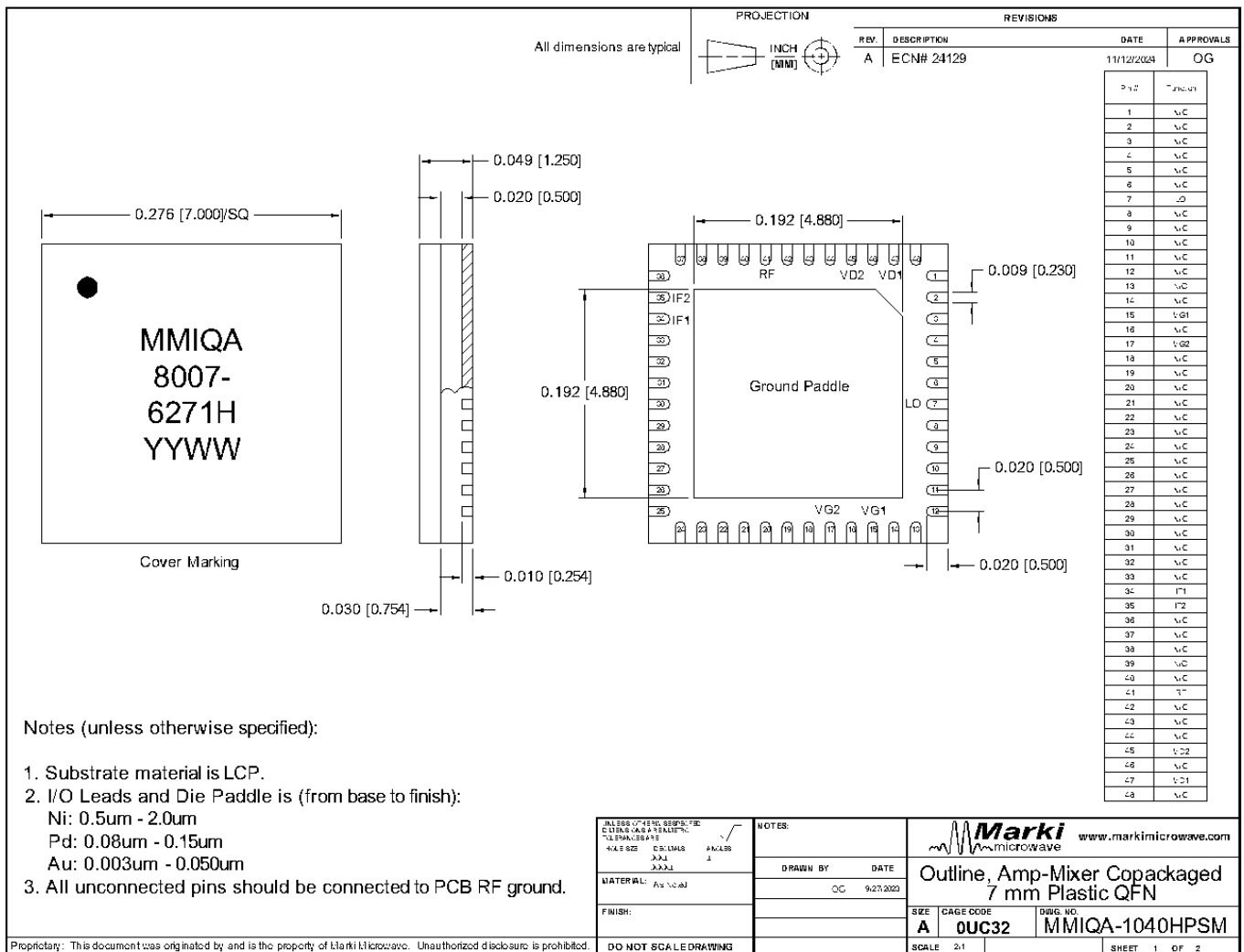

Evaluation Board - Outline Drawing

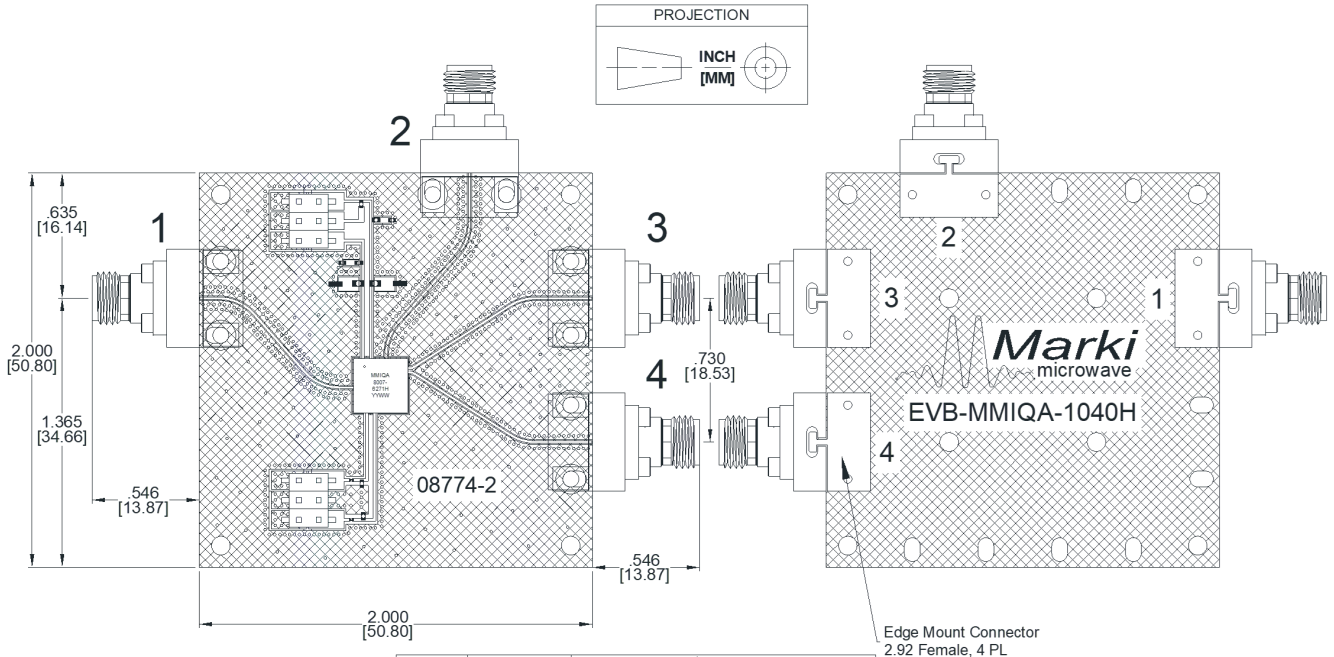

Port #	Function	VDC	Connector Type
1	LO	Open Line	2.92mm Female
2	RF	Short Circuit	2.92mm Female
3	I	0.674	2.92mm Female
4	Q	0.674	2.92mm Female

Note: Eval Connectors are not removeable.

DISCLAIMER

MARKI MICROWAVE, INC., ("MARKI") PROVIDES TECHNICAL SPECIFICATIONS AND DATA (INCLUDING DATASHEETS), APPLICATION OR OTHER DESIGN ADVICE, WEB TOOLS, AND OTHER INFORMATION AND RESOURCES "AS IS" AND WITH ALL FAULTS. MARKI DISCLAIMS ALL WARRANTIES, EXPRESS OR IMPLIED, INCLUDING, WITHOUT LIMITATION, ANY IMPLIED WARRANTIES OF MERCHANTABILITY, FITNESS FOR A PARTICULAR PURPOSE, OR NON-INFRINGEMENT. These resources are intended for developers skilled in the art designing with Marki products. You are solely responsible for (1) selecting the appropriate products for your application, (2) designing, validating, and testing your application, and (3) ensuring your application meets applicable standards and other requirements. Marki makes no guarantee regarding the suitability of its products for any particular purpose, nor does Marki assume any liability whatsoever arising out of your use or application of any Marki product.

Marki grants you permission to use these resources only for development of an application that uses Marki products. Other reproduction or use of these resources is strictly prohibited. No license is granted to any other Marki intellectual property or to any third-party intellectual property. Marki reserves the right to make changes to the product(s) or information contained herein without notice.

MARKI MICROWAVE and T3 MIXER are trademarks or registered trademarks of Marki Microwave, Inc. All other trademarks used are the property of their respective owners.

© 2023 - 2024, Marki Microwave, Inc