

MM1-30100LM

GaAs MMIC Double Balanced mmWave Mixer

DEVICE OVERVIEW

General Description

MM1-30100L is a GaAs MMIC double balanced mixer that features excellent conversion loss, superior isolations, and spurious performance across an incredibly broad bandwidth. The MM1-30100L works well as both an up and down converter from the Ka band through mmWave/G band. The MM1-30100L is recommended for mmWave frequency conversion applications that require high linearity. It is available as both wire bondable die and as a connectorized module.

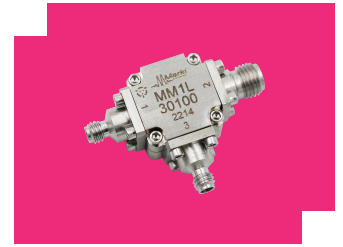

Features

- Ultra broadband, high linearity mmWave frequency conversion
- High LO to RF isolation
- Up or down conversion

Applications

- mmWave Frequency Conversion
- Test and Measurement Equipment
- Automotive Radar
- mmWave Tuner Mixer
- 5G Test Receivers

Functional Block Diagram

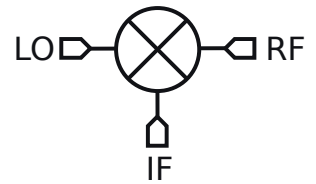

Part Ordering Options

Part Number	Description	Package	Connectors	Green Status	Product Lifecycle	Export Classification
MM1-30100LM	GaAs MMIC Double Balanced mmWave Mixer	M	<u>Standard</u>	REACH RoHS	Released	EAR99

Table Of Contents

- **Device Overview**
 - General Description
 - Features
 - Applications
 - Functional Block Diagram
- **Port Configuration and Functions**
 - Port Diagram
 - Port Functions
- **Revision History**
- **Specifications**
 - Absolute Maximum Ratings
 - Package Information
 - Recommended Operating Conditions
 - Sequencing Requirements
 - Electrical Specifications
 - Typical Performance Plots
- **Mechanical Data**
 - Outline Drawing

Revision History

Revision Code	Revision Date	Comment
-	2022-05-01	Datasheet Initial Release
A	2024-01-17	Outline Drawing Updated

Port Configuration and Functions

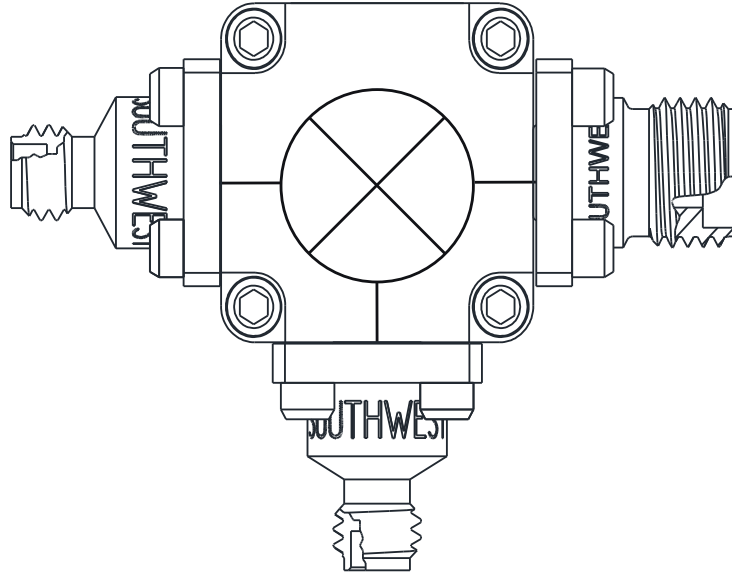

Port Diagram

The MM1-30100L has the input and output ports given in Port Functions. The MM1-30100L can be used in either an up or down conversion. For configuration A, input the LO into port 3, use port 1 for the RF, and port 2 for the IF. For configuration B, input the LO into port 1, use port 3 for the RF, and port 2 for the IF.



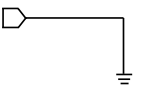
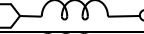

Port Functions

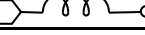
Configuration A

Port	Function	Connector Type	Description	Equivalent Circuit for Package
GND	Ground	-	M package ground provided through metal housing and outer coax conductor.	
Port 1	RF	1.0F	Port 1 is DC open for the CH and M packages.	
Port 2	IF	2.92F	Port 2 is diode connected for the CH and M package.	
Port 3	LO	1.0F	Port 3 is DC open for the CH and M packages.	

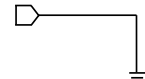
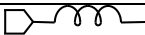
Configuration B

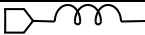
Port	Function	Connector Type	Description	Equivalent Circuit for Package
GND	Ground	-	M package ground provided through metal housing and outer coax conductor.	
Port 1	LO	1.0F	Port 1 is DC open for the CH and M packages.	
Port 2	IF	2.92F	Port 2 is diode connected for the CH and M package.	
Port 3	RF	1.0F	Port 3 is DC open for the CH and M packages.	

Specifications

Absolute Maximum Ratings

The Absolute Maximum Ratings indicate limits beyond which damage may occur to the device. If these limits are exceeded, the device may be inoperable or have a reduced lifetime.

Parameter	Maximum Rating	Unit
Maximum Operating Temperature	100	°C
Maximum Storage Temperature	125	°C
Minimum Operating Temperature	-55	°C
Minimum Storage Temperature	-65	°C
Power Handling, at any Port	30	dBm

Package Information

Parameter	Details	Rating
ESD	250 to < 500 Volts	HBM Class 1A
Weight	Package name: M	22g
Dimensions	-	33.33 x 23.80 mm

Recommended Operating Conditions

The Recommended Operating Conditions indicate the limits, inside which the device should be operated, to guarantee the performance given in Electrical Specifications. Operating outside these limits may not necessarily cause damage to the device, but the performance may degrade outside the limits of the electrical specifications. For limits, above which damage may occur, see Absolute Maximum Ratings.

Parameter	Min	Nominal	Max	Unit
Ambient Temperature	-55	25	100	°C
LO Input Power	14	16	-	dBm

Sequencing Requirements

There is no requirement to apply power to the ports in a specific order. However, it is recommended to provide a 50Ω termination to each port before applying power. This is a passive diode mixer that requires no DC bias.

Electrical Specifications

The electrical specifications apply at TA=+25°C in a 50Ω system. Typical data shown is for the connectorized M package mixer used in the forward direction with a sine wave LO input. Specifications shown for configuration A. LO power used for characterization varies by band. Saturated amplifiers used were AMM-6702 and A-3567. Min and Max limits apply only to our connectorized units and are guaranteed at TA=+25°C. All bare die are 100% DC tested and visually inspected.

Parameter	Port Configuration	Test Conditions	Min	Typ	Max	Unit
Conversion Loss ¹	-	RF/LO = 30 - 130 GHz I = DC - 0.2 GHz	-	8.5	-	dB
IF Frequency Range	-	-	0	-	20	GHz
LO Frequency Range	-	-	30	-	100	GHz
Noise Figure ²	-	RF/LO = 30 - 130 GHz I = DC - 0.2 GHz	-	8.5	-	dB
RF Frequency Range	-	-	30	-	100	GHz

^[1] Measured as a down converter to a fixed 91MHz IF.

^[2] Mixer Noise Figure typically measures within 0.5 dB of conversion loss for IF frequencies greater than 5 MHz.

Typical Performance Plots

Due to difficulty generating strong LO signals at mmWave frequencies LR Isolation is measured with a small signal LO. Isolation will improve with a stronger LO signal. Discontinuity in conversion loss measurement is due to splitting the measurement into multiple bands. IIP3 is only measured up to 67GHz due to limitations in measurement setup.

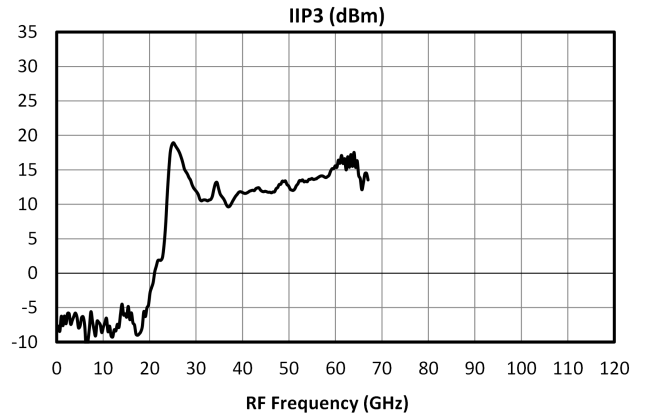
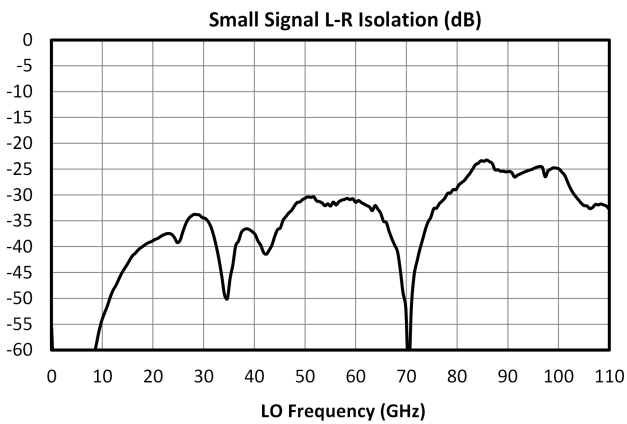
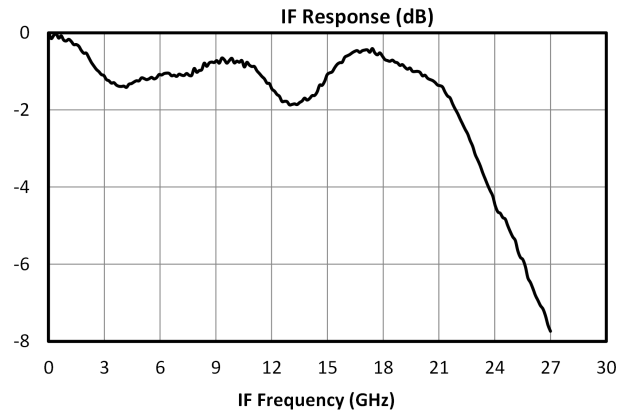
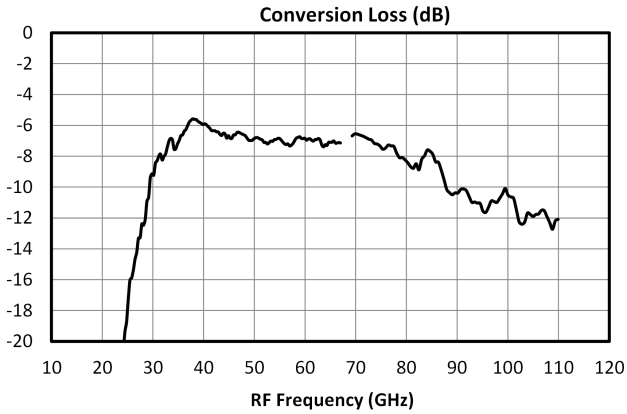

Mechanical Data

Outline Drawing

Download : [Outline 2D Drawing](#) | [Outline 3D Drawing](#) | [Outline 3D STP](#)

All measurements are typical

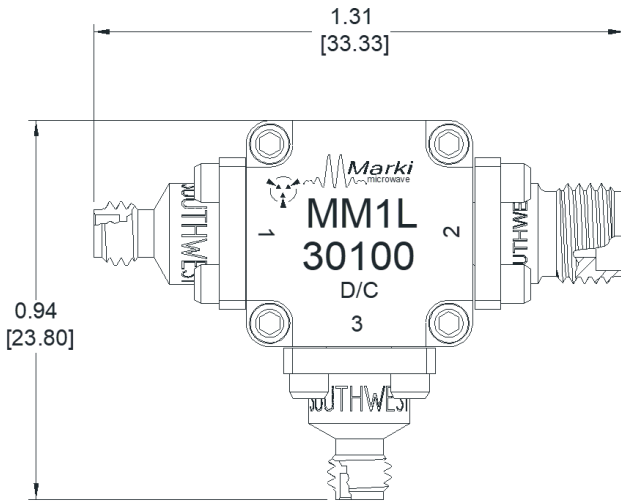
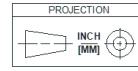

Topside View

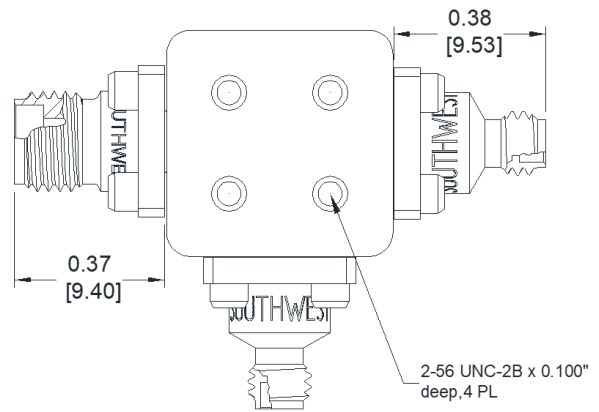

Bottomside View

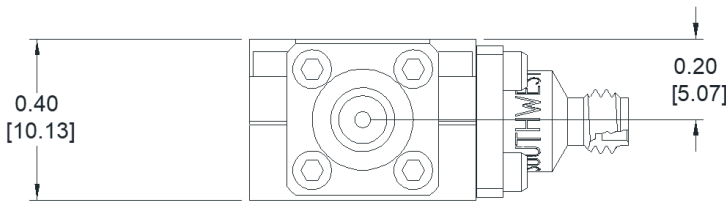

1.0 mm Connector View

Note: Connectors are not removable. Do not attempt replacing.

Port	Connector Type
1,3	1.0 mm Female
2	2.92 mm Female

Function	Configuration A Port Number	Configuration B Port Number
RF	1	3
IF	2	2
LO	3	1

- All measurements are typical.
- Attach 1.0mm connectors with 45 N-cm (4 in-lb) torque wrench.

DISCLAIMER

MARKI MICROWAVE, INC., ("MARKI") PROVIDES TECHNICAL SPECIFICATIONS AND DATA (INCLUDING DATASHEETS), APPLICATION OR OTHER DESIGN ADVICE, WEB TOOLS, AND OTHER INFORMATION AND RESOURCES "AS IS" AND WITH ALL FAULTS. MARKI DISCLAIMS ALL WARRANTIES, EXPRESS OR IMPLIED, INCLUDING, WITHOUT LIMITATION, ANY IMPLIED WARRANTIES OF MERCHANTABILITY, FITNESS FOR A PARTICULAR PURPOSE, OR NON-INFRINGEMENT.

These resources are intended for developers skilled in the art designing with Marki products. You are solely responsible for (1) selecting the appropriate products for your application, (2) designing, validating, and testing your application, and (3) ensuring your application meets applicable standards and other requirements. Marki makes no guarantee regarding the suitability of its products for any particular purpose, nor does Marki assume any liability whatsoever arising out of your use or application of any Marki product.

Marki grants you permission to use these resources only for development of an application that uses Marki products. Other reproduction or use of these resources is strictly prohibited. No license is granted to any other Marki intellectual property or to any third-party intellectual property. Marki reserves the right to make changes to the product(s) or information contained herein without notice.

MARKI MICROWAVE and T3 MIXER are trademarks or registered trademarks of Marki Microwave, Inc. All other trademarks used are the property of their respective owners.

© 2022, 2024, Marki Microwave, Inc