

MM1-0832LSM-2

GaAs MMIC Double Balanced Mixer

DEVICE OVERVIEW

General Description

The MM1-0832LSM is a GaAs MMIC double balanced mixer that is optimized for high frequency applications. MM1-0832LSM is a high frequency X band mixer that works well as both an up and down converter through Ka band. This mixer offers low conversion loss and high LO to RF isolations at low LO powers. The sister MM1-0832HSM is recommended for medium power applications. The MM1-0832LSM is available in a 3x3 mm QFN package. Evaluation boards are available.

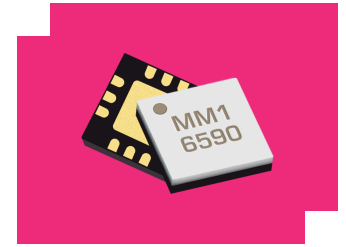

Features

- High IF frequency
- RoHS Compliant

Applications

- Test and Measurement Equipment
- Electronic Warfare
- 5G
- SATCOM

Functional Block Diagram

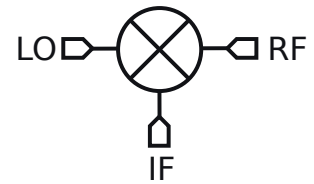

Part Ordering Options

Part Number	Description	Package	Green Status	Product Lifecycle	Export Classification
MM1-0832LSM-2	GaAs MMIC Double Balanced Mixer	QFN	REACH RoHS	Released	EAR99
EVAL-MM1-0832L	Evaluation Board, GaAs MMIC 8 - 32 GHz Double Balanced Mixer	EVAL	REACH RoHS	Released	EAR99

Table Of Contents

- **Device Overview**
 - General Description
 - Features
 - Applications
 - Functional Block Diagram
- **Port Configuration and Functions**
 - Port Diagram
 - Port Functions
- **Revision History**
- **Specifications**
 - Absolute Maximum Ratings
 - Package Information
 - Recommended Operating Conditions
 - Sequencing Requirements
 - Electrical Specifications
 - Typical Performance Plots
 - Typical Performance Plots: IP3
 - Typical Performance Plots: LO Harmonic Isolation
 - Spur Tables
- **Operation**
 - Application Circuit
 - Application Circuit Description
- **Mechanical Data**
 - Outline Drawing
- **Footprint Image**
- **Evaluation Board**
 - Evaluation Board Outline Drawing

Revision History

Revision Code	Revision Date	Comment
-	2019-01-01	Datasheet Initial Release
A	2019-08-01	Updated Low Side LO Plot Titles.
B	2020-08-01	Updated Pin 2 Description & Equivalent Circuit

Port Configuration and Functions

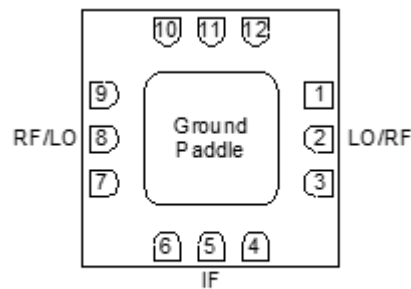

Port Diagram

A bottom-up view of the MM1-0832LSM's SM package outline drawing is shown below. The MM1-0832LSM has the input and output ports given in Port Functions. The MM1-0832LSM can be used in either an up or down conversion. For configuration A, input the LO into pin 2, use pin 8 for the RF, and pin 5 for the IF. For configuration B, input the LO into pin 8, use pin 2 for the RF, and pin 5 for the IF.



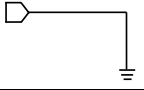
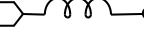

Port Functions

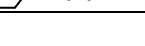
Configuration A

Port	Function	Description	Equivalent Circuit for Package
GND	Ground	SM package ground path is provided through the ground paddle.	
Pin 2	LO	Pin 2 is DC open and AC matched to 50 Ohms from 8 to 32 GHz. Blocking capacitor is optional.	
Pin 5	IF	Pin 5 is DC coupled to the diodes. Blocking capacitor is optional.	
Pin 8	RF	Pin 8 is DC open and AC matched to 50 Ohms from 8 to 32 GHz.	

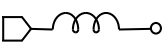
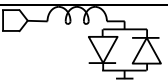
Configuration B

Port	Function	Description	Equivalent Circuit for Package
GND	Ground	SM package ground path is provided through the ground paddle.	
Pin 2	RF	Pin 2 is DC open and AC matched to 50 Ohms from 8 to 32 GHz. Blocking capacitor is optional.	
Pin 5	IF	Pin 5 is DC coupled to the diodes. Blocking capacitor is optional.	
Pin 8	LO	Pin 8 is DC open and AC matched to 50 Ohms from 8 to 32 GHz.	

Specifications

Absolute Maximum Ratings

The Absolute Maximum Ratings indicate limits beyond which damage may occur to the device. If these limits are exceeded, the device may be inoperable or have a reduced lifetime.

Parameter	Maximum Rating	Unit
Maximum Operating Temperature	100	°C
Maximum Storage Temperature	125	°C
Minimum Operating Temperature	-55	°C
Minimum Storage Temperature	-65	°C
Pin 2 DC Current	30	mA
Pin 5 DC Current	15	mA
Power Handling, at any Port	28	dBm

Package Information

Parameter	Details	Rating
ESD	250 to < 500 Volts	HBM Class 1A
Dimensions	-	3 x 3 mm
Moisture Sensitivity Level	-	MSL 1

Recommended Operating Conditions

The Recommended Operating Conditions indicate the limits, inside which the device should be operated, to guarantee the performance given in Electrical Specifications. Operating outside these limits may not necessarily cause damage to the device, but the performance may degrade outside the limits of the electrical specifications. For limits, above which damage may occur, see Absolute Maximum Ratings.

Parameter	Min	Nominal	Max	Unit
Ambient Temperature	-55	25	100	°C
LO Input Power	8	-	15	dBm

Sequencing Requirements

There is no requirement to apply power to the ports in a specific order. However, it is recommended to provide a 50Ω termination to each port before applying power. This is a passive diode mixer that requires no DC bias.

Electrical Specifications

The electrical specifications apply at TA=+25°C in a 50Ω system. Typical data shown is for a down conversion application with a +12dBm sine wave LO input.

Parameter	Port Configuration	Test Conditions	Min	Typ	Max	Unit
Conversion Loss ¹	A	RF/LO = 8-30 GHz I = 0.2 - 12 GHz	-	8.5	-	dB
Conversion Loss ²	A	RF/LO = 8 - 30 GHz I = DC - 0.2 GHz	-	7.5	10.5	dB
Input 1 dB Gain Compression Point (P1dB)	A	-	-	2	-	dBm
Input IP3	A	RF/LO = 8 - 30 GHz I = DC - 0.2 GHz	-	11	-	dBm
Conversion Loss ³	B	RF/LO = 8-30 GHz I = 0.2 - 12 GHz	-	10.5	-	dB
Conversion Loss ⁴	B	RF/LO = 8 - 30 GHz I = DC - 0.2 GHz	-	9	12	dB
Input 1 dB Gain Compression Point (P1dB)	B	-	-	4	-	dBm
Input IP3	B	RF/LO = 8 - 30 GHz I = DC - 0.2 GHz	-	14	-	dBm
IF Frequency Range	-	-	0	-	12	GHz
Isolation, LO to IF	-	IF/LO = 8 - 32 GHz	-	23	-	dB
Isolation, LO to RF	-	RF/LO = 8 - 32 GHz	-	36	-	dB
Isolation, RF to IF	-	RF/IF = 8 - 32 GHz	-	23	-	dB
LO Frequency Range	-	-	8	-	30	GHz
Noise Figure ⁵	-	RF/LO = 8-30 GHz I = DC - 0.2 GHz	-	9	-	dB
RF Frequency Range	-	-	8	-	32	GHz

[1][2][3][4] Measured as a down converter to a fixed 91MHz IF.

[5] Mixer Noise Figure typically measures within 0.5 dB of conversion loss for IF frequencies greater than 5 MHz.

Typical Performance Plots

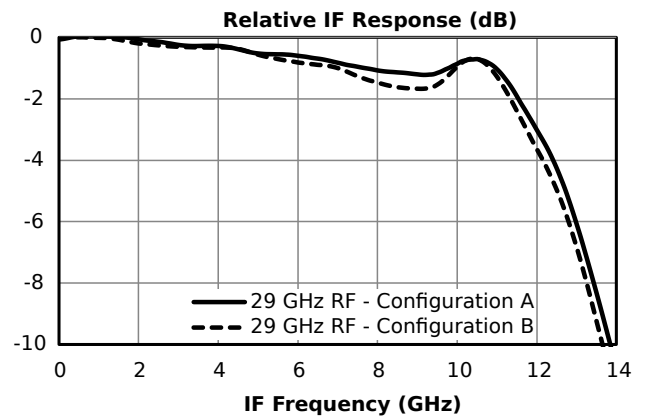
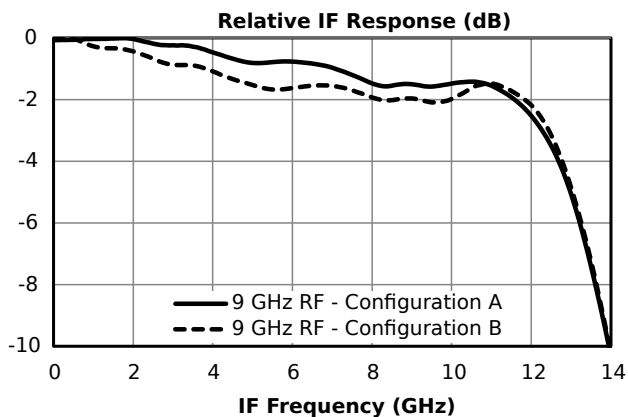
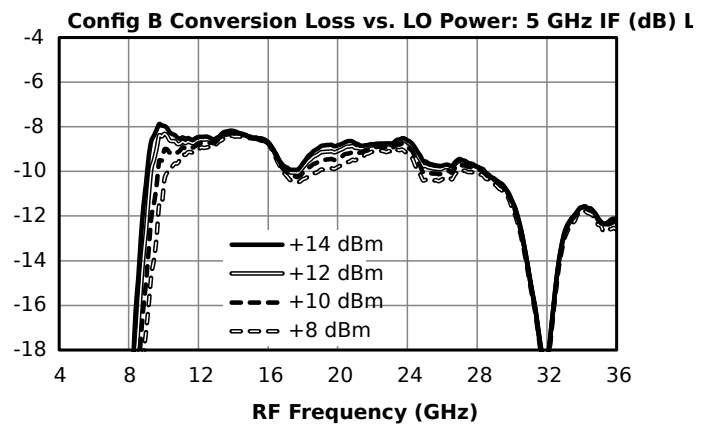
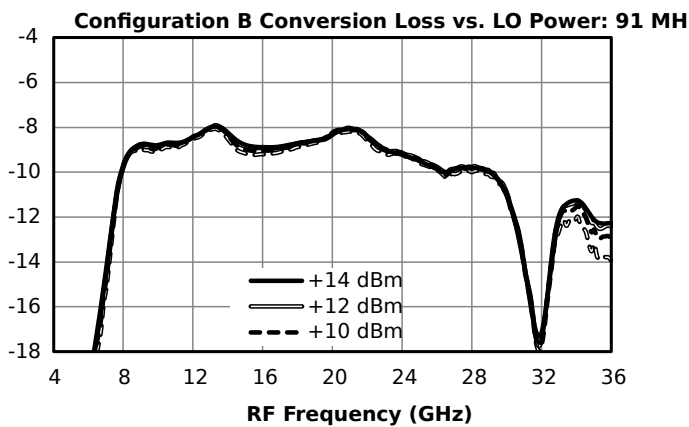
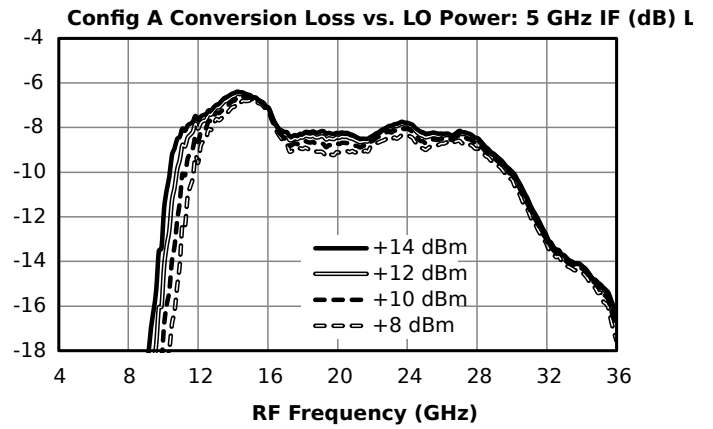
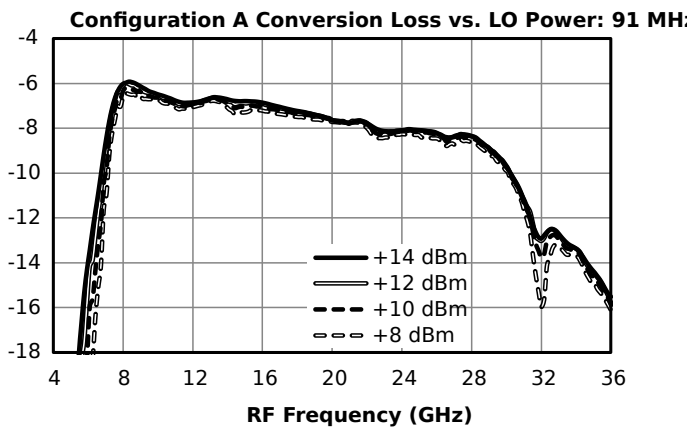
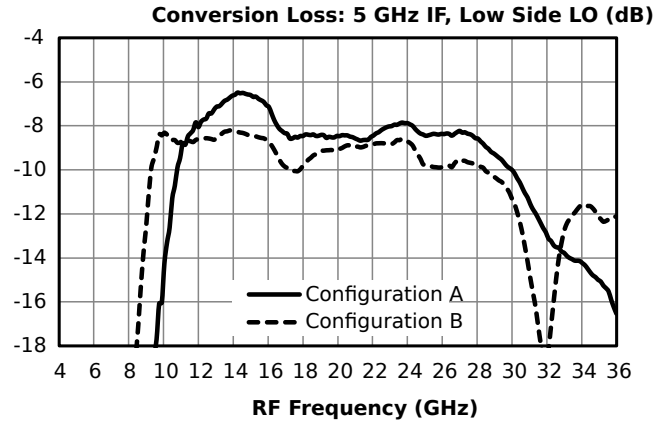
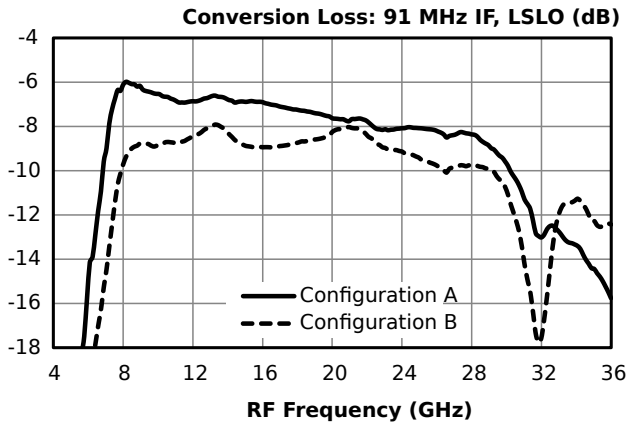

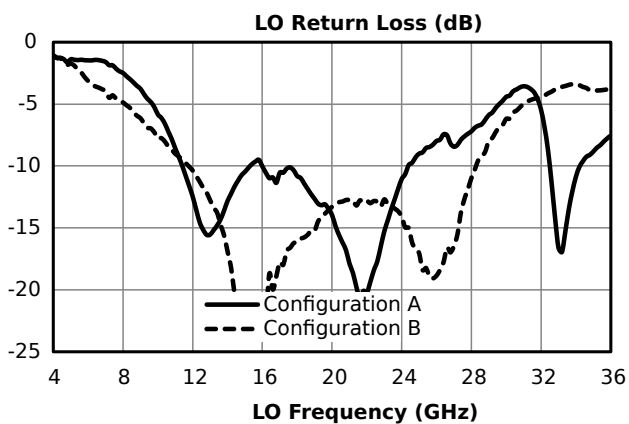
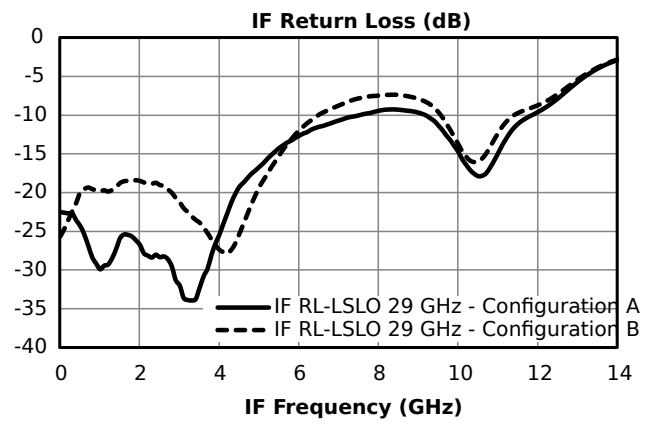
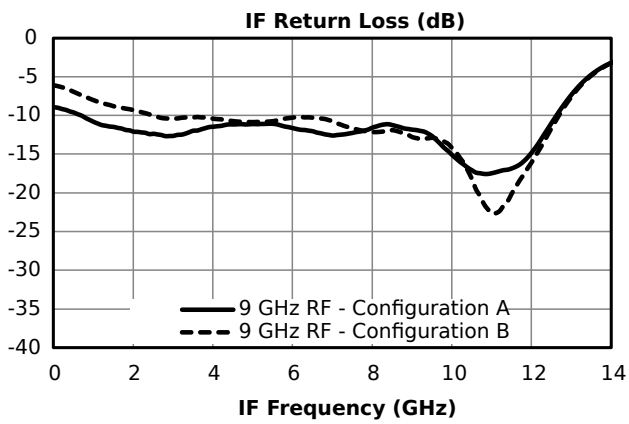
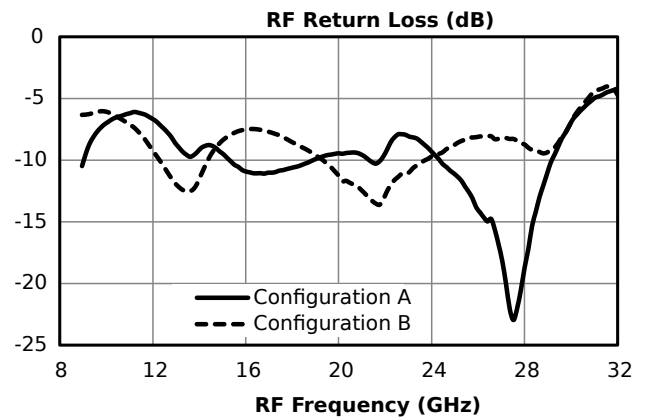
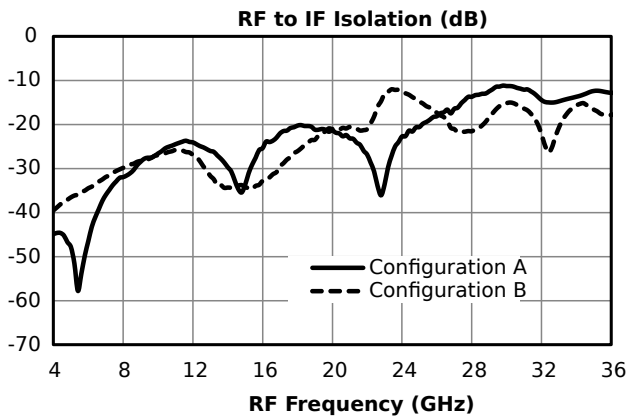
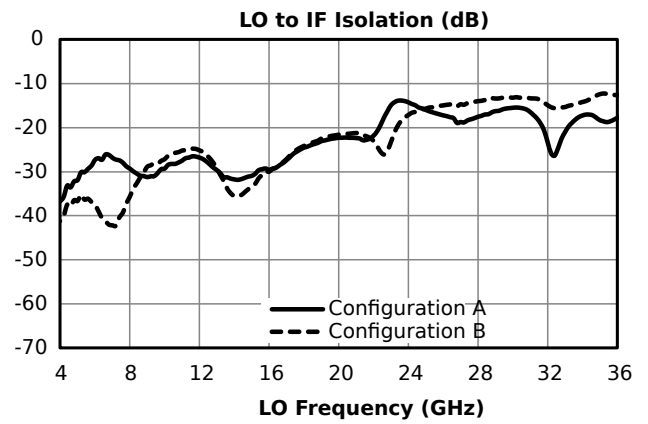
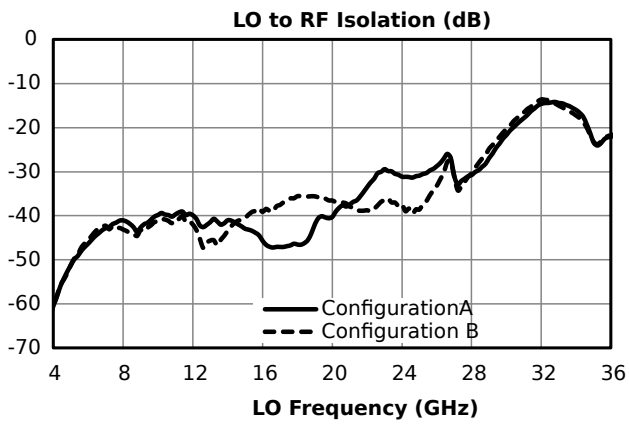

Typical Performance Plots: IP3

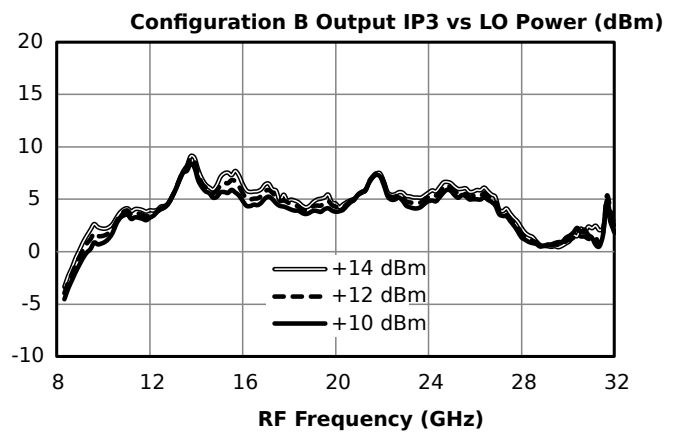
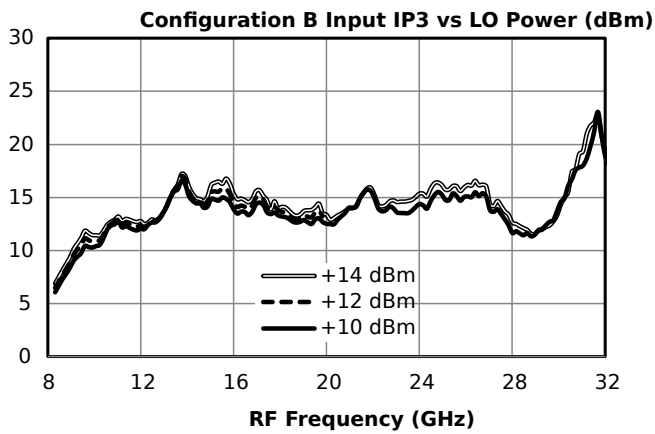
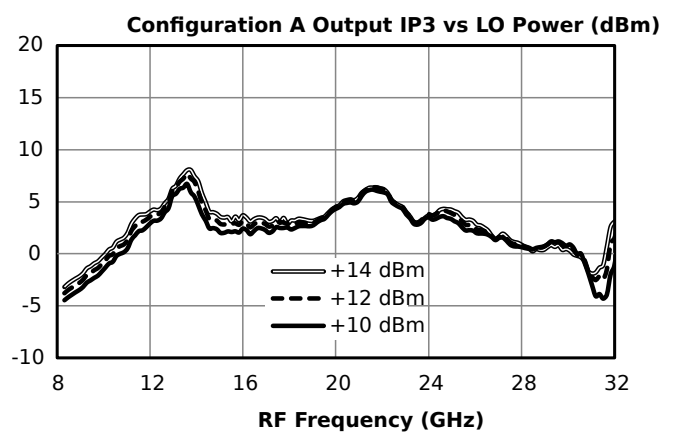
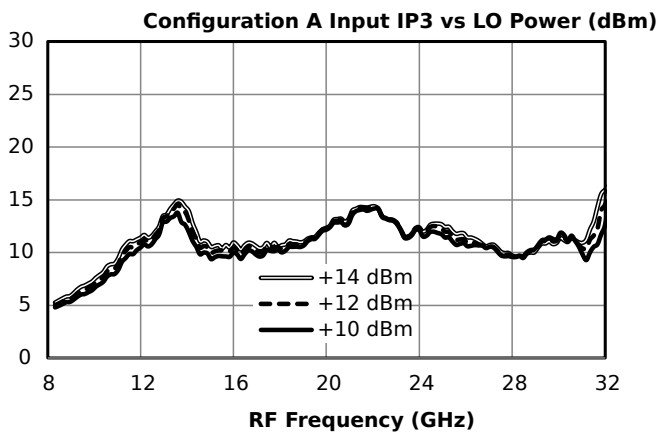
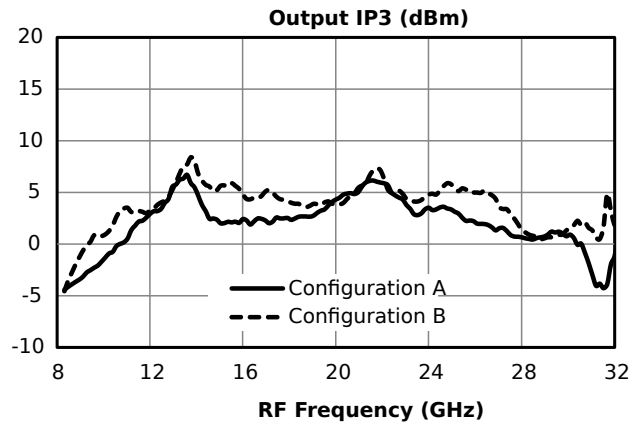
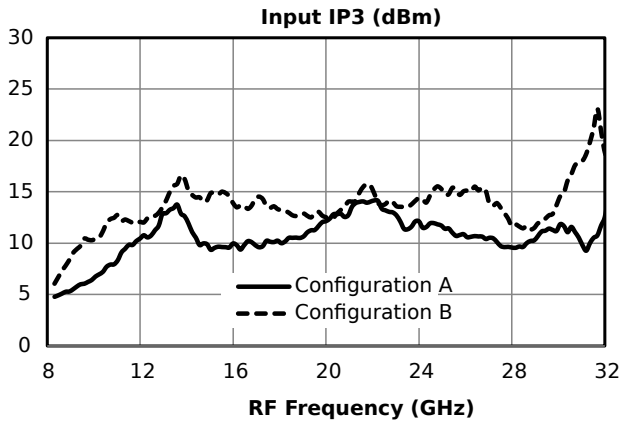

Typical Performance Plots: LO Harmonic Isolation

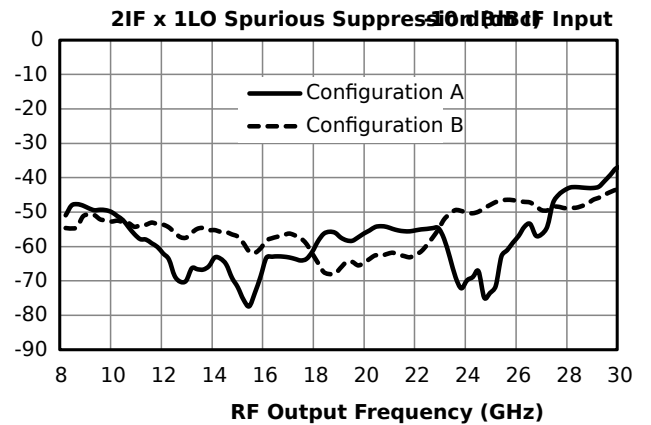
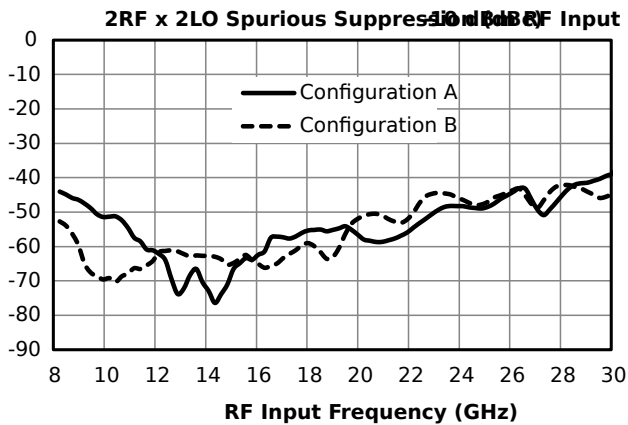
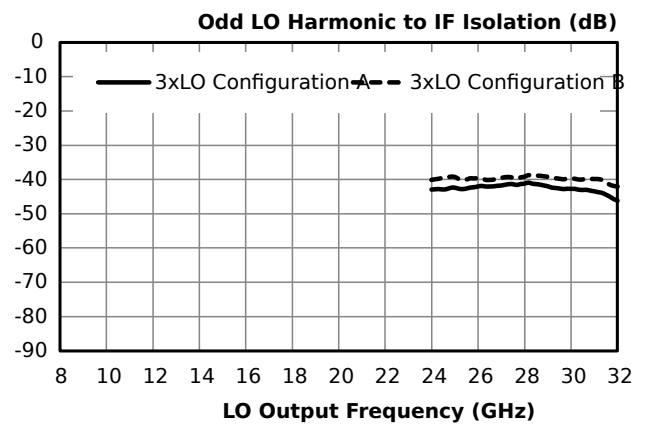
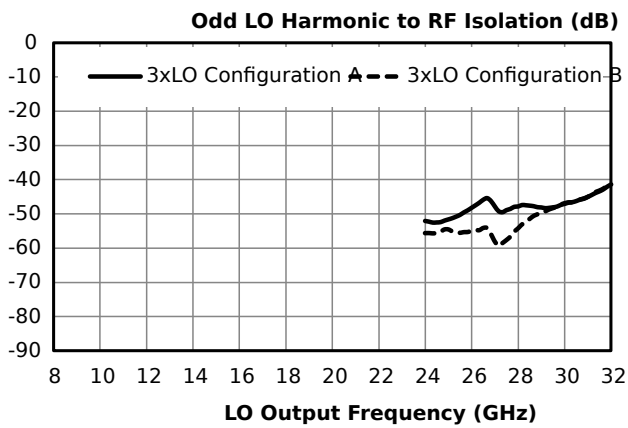
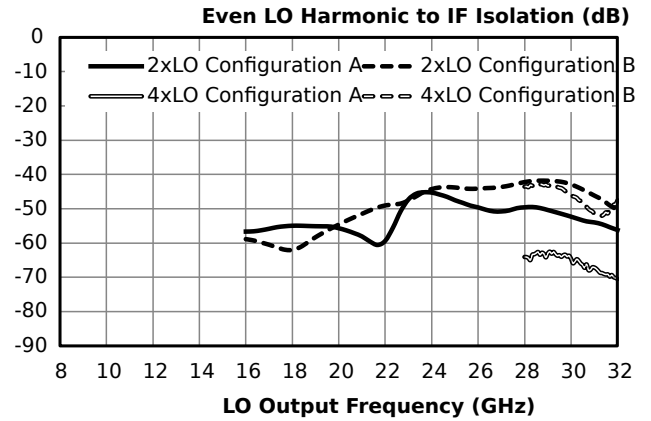
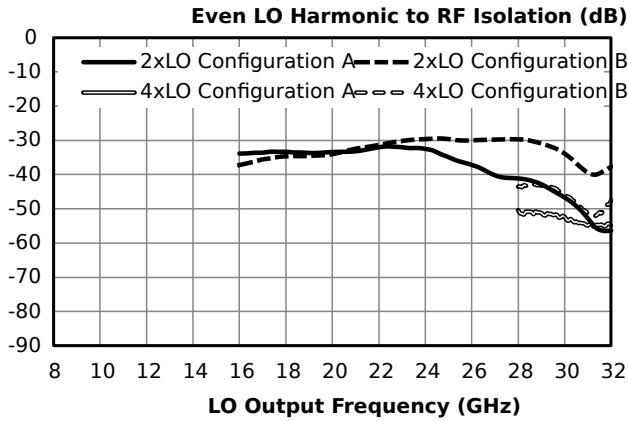

Spur Table

Typical Spurious Performance: Down-Conversion

Typical spurious data is provided by selecting RF and LO frequencies ($\pm m \cdot \text{LO} \pm n \cdot \text{RF}$) within the RF/LO bands, to create a spurious output within the IF band. The mixer is swept across the full spurious band and the mean is calculated. The numbers shown in the table below are for a -10 dBm RF input. Spurious suppression is scaled for different RF power levels by $(n-1)$, where "n" is the RF spur order. For example, the 2RF x 2LO spur is 53 dBc for a -10 dBm input, so a -20 dBm RF input creates a spur that is $(2-1) \times (-10 \text{ dB})$ lower, or 63 dBc. Data is shown for the frequency plan in 3.6 Typical Performance. mLOx0RF plots can be found in section 3.6.2 Typical Performance Plots: LO Harmonic Isolation. 0LOx1RF plot is identical to the plot of LO-RF isolation.

Typical Down-conversion spurious suppression (dBc): Config A (B)

-10 dBm RF Input	0xLO	1xLO	2xLO	3xLO	4xLO	5xLO
0xRF	-	22 (23)	38 (33)	48 (51)	53 (47)	61 (58)
1xRF	16 (11)	Reference	33 (37)	13 (14)	45 (41)	41 (26)
2xRF	62 (65)	54 (39)	53 (54)	54 (44)	58 (63)	51 (49)
3xRF	58 (65)	46 (47)	67 (79)	56 (58)	65 (77)	55 (60)
4xRF	94 (89)	86 (80)	76 (84)	90 (82)	88 (94)	92 (85)
5xRF	94 (101)	87 (82)	90 (93)	92 (100)	100 (108)	97 (99)

Typical Spurious Performance: Up-Conversion

Typical spurious data is taken by mixing an input within the IF band, with LO frequencies ($\pm m*LO \pm n*IF$), to create a spurious output within the RF output band. The mixer is swept across the full spurious output band and the mean is calculated. The numbers shown in the table below are for a -10 dBm IF input. Spurious suppression is scaled for different IF input power levels by (n-1), where “n” is the IF spur order. For example, the 2IFx1LO spur is typically 57 dBc for a -10 dBm input with a sine-wave LO, so a -20 dBm IF input creates a spur that is (2-1) x (-10 dB) lower, or 67 dBc. Data is shown for the frequency plan in 3.6 Typical Performance.

Typical Up-conversion spurious suppression (dBc): Config A (B)

-10 dBm RF Input	0xLO	1xLO	2xLO	3xLO	4xLO	5xLO
0xIF	-	51 (50)	53 (49)	43 (40)	66 (56)	57 (49)
1xIF	24 (21)	Reference	37 (39)	15 (15)	38 (39)	35 (33)
2xIF	71 (52)	57 (54)	46 (35)	51 (60)	56 (46)	50 (49)
3xIF	83 (90)	54 (55)	61 (69)	49 (42)	64 (77)	58 (63)
4xIF	100 (90)	88 (94)	87 (73)	87 (94)	73 (73)	89 (94)
5xIF	108 (114)	90 (91)	97 (104)	87 (77)	96 (106)	80 (84)

Application Circuit

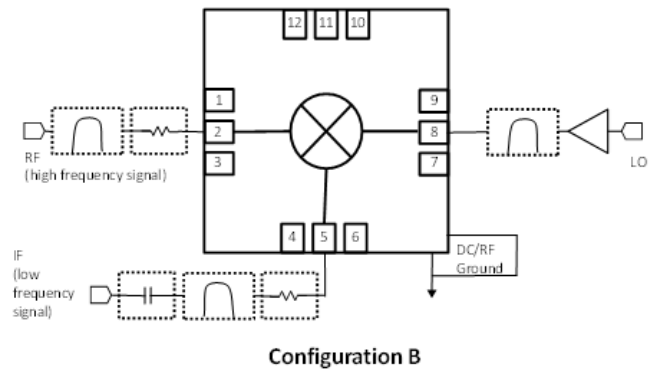
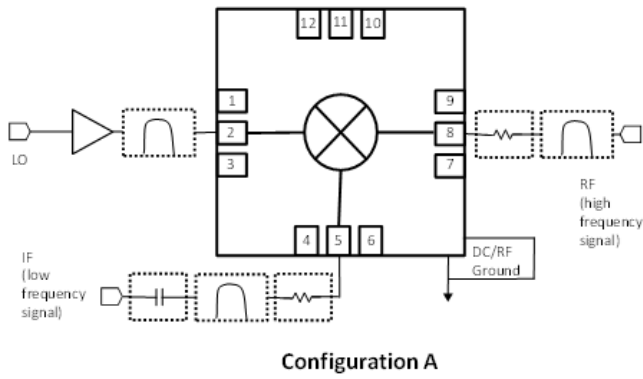

Application Circuit Description

Ports Operation

IF Port – Used as input on an upconversion, output on downconversion, or LO port in a band shifting application. Signals should be connected by 50 ohm microstrip or coplanar traces to well matched broadband 50 ohm sources and loads. Blocking capacitor is recommended if DC voltage is present on the line.

RF Port – Used as input on a downconversion, output on upconversion, or output in a band shifting application. Signals should be connected by 50 ohm microstrip or coplanar traces to well matched broadband 50 ohm sources and loads.

Filtering and Matching- Filtering is generally desired for spurious and image removal on the output port of the mixer. Reflective filters can cause out of band signals to reflect back into the mixer and cause conversion loss ripple, erroneous spurs, and other undesired behaviors. To eliminate these problems it is recommend that the filters be placed as close to the output port as possible. If undesired behavior is still observed, a diplexer with one port terminated or a 1-3 dB attenuator may reduce this problem.

RF Ground – The ground paddle of the QFN should be connected to a low noise RF ground with very low electrical resistance for high frequency operation.

LO Port – The noise floor of the LO input signal should be less than the value of the noise floor plus isolation of the mixer, or a filter is recommended to prevent reduction in dynamic range. An LO amplifier is required if the LO power is below the recommended drive level. It is important to use an amplifier with a broadband 50 ohm match such that it does not reflect spurious signals back into the mixer or other system circuitry.

Mechanical Data

Outline Drawing

Download : [Outline 2D Drawing](#) | [Outline 3D Drawing](#) | [Outline 3D STP](#)

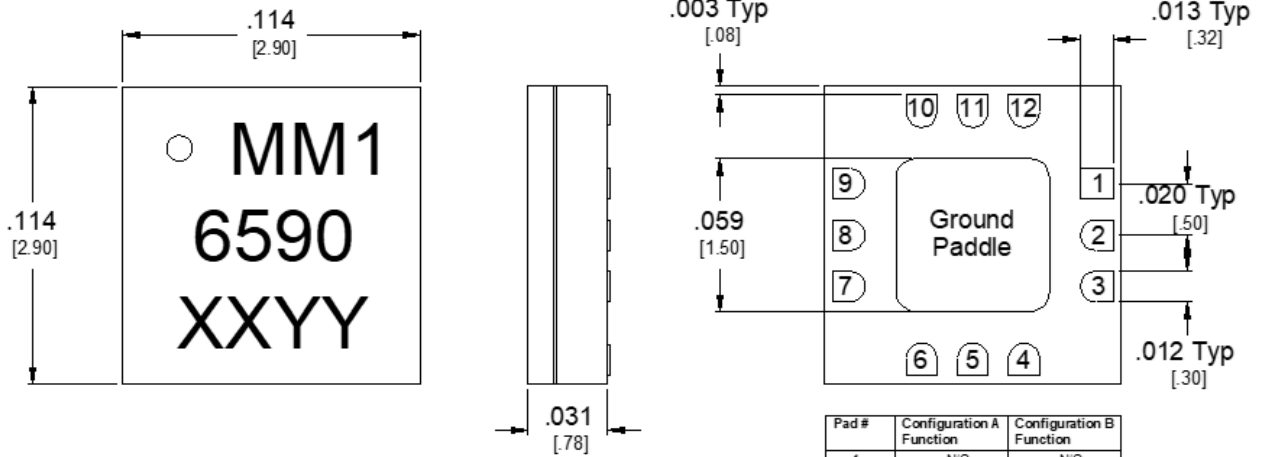

Pad #	Configuration A Function	Configuration B Function
1	N/C	N/C
2	LO	RF
3	N/C	N/C
4	N/C	N/C
5	IF	IF
6	N/C	N/C
7	N/C	N/C
8	RF	LO
9	N/C	N/C
10	N/C	N/C
11	N/C	N/C
12	N/C	N/C

1. Substrate material is ceramic.
2. I/O Leads and Ground Paddle plating is (from base to finish):
 - Ni: 8.89um MAX
 - Pd: 0.17um MAX
 - Au: 0.254um MAX
3. All unconnected pads should be connected to PCB RF ground.

1.27um MIN
0.07um MIN
0.03um MIN

Footprint Image

Download : [Footprint Drawing](#)

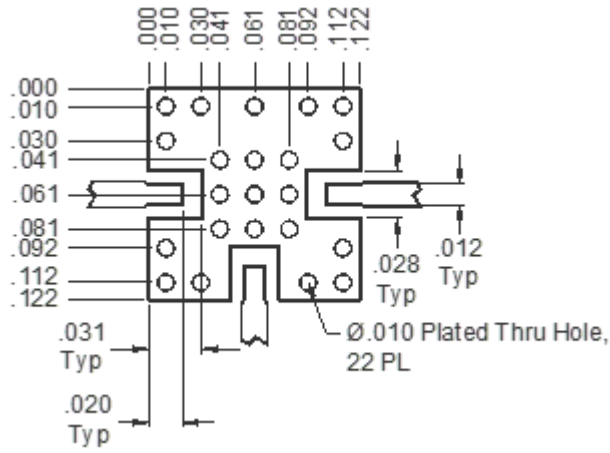

Evaluation Board - Outline Drawing

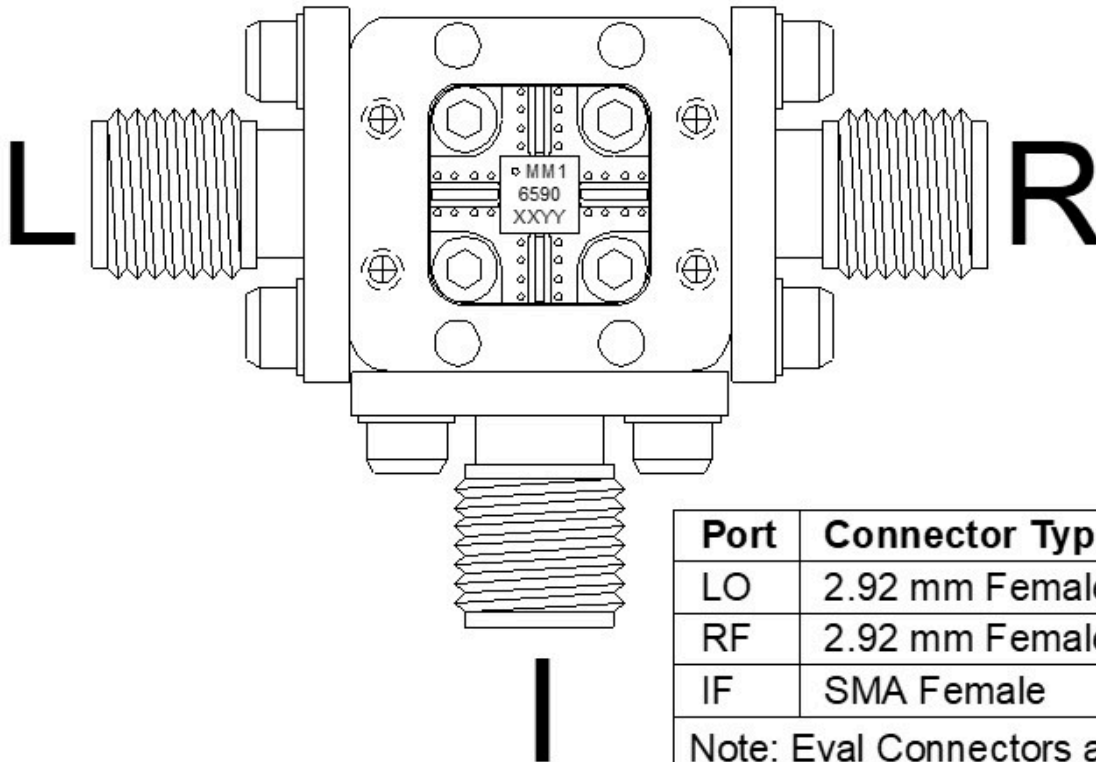

Port	Connector Type
LO	2.92 mm Female
RF	2.92 mm Female
IF	SMA Female
Note: Eval Connectors are not removeable.	

DISCLAIMER

MARKI MICROWAVE, INC., ("MARKI") PROVIDES TECHNICAL SPECIFICATIONS AND DATA (INCLUDING DATASHEETS), APPLICATION OR OTHER DESIGN ADVICE, WEB TOOLS, AND OTHER INFORMATION AND RESOURCES "AS IS" AND WITH ALL FAULTS. MARKI DISCLAIMS ALL WARRANTIES, EXPRESS OR IMPLIED, INCLUDING, WITHOUT LIMITATION, ANY IMPLIED WARRANTIES OF MERCHANTABILITY, FITNESS FOR A PARTICULAR PURPOSE, OR NON-INFRINGEMENT.

These resources are intended for developers skilled in the art designing with Marki products. You are solely responsible for (1) selecting the appropriate products for your application, (2) designing, validating, and testing your application, and (3) ensuring your application meets applicable standards and other requirements. Marki makes no guarantee regarding the suitability of its products for any particular purpose, nor does Marki assume any liability whatsoever arising out of your use or application of any Marki product.

Marki grants you permission to use these resources only for development of an application that uses Marki products. Other reproduction or use of these resources is strictly prohibited. No license is granted to any other Marki intellectual property or to any third-party intellectual property. Marki reserves the right to make changes to the product(s) or information contained herein without notice.

MARKI MICROWAVE and T3 MIXER are trademarks or registered trademarks of Marki Microwave, Inc. All other trademarks used are the property of their respective owners.

© 2019 - 2020, Marki Microwave, Inc