

BT-0065 Bias Tee

DEVICE OVERVIEW

General Description

The BT-0065 is constructed using a custom-made, resonance-free conical inductor to achieve extremely broadband performance. By minimizing the overall inductor size and using proprietary packaging techniques, the BT-0065 is a superior option in terms of performance, reliability and ease-of-use when compared to cumbersome self-made bias tees employing off-the-shelf conical inductors. The extremely low cutoff and resonance free operation makes the BT-0065 suitable for biasing amplifiers, lasers, and modulators driven with high frequency data patterns.

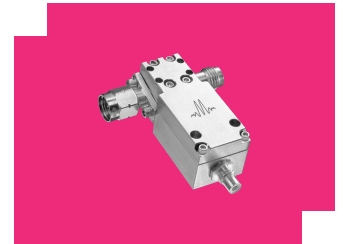

Features

- Broadband: 4 kHz to 65 GHz
- Low Insertion Loss
- Non-Resonant
- Compact Size

Applications

- Test and Measurement Equipment

Functional Block Diagram

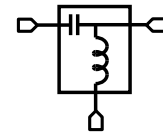

Part Ordering Options

Part Number	Description	Connectors	Green Status	Product Lifecycle	Export Classification
BT-0065	Bias Tee	<u>Standard</u>	REACH RoHS	Released	EAR99

Table Of Contents

- **Device Overview**
 - General Description
 - Features
 - Applications
 - Functional Block Diagram
- **Port Configuration and Functions**
 - Port Functions
- **Revision History**
- **Specifications**
 - Absolute Maximum Ratings
 - Package Information
 - Electrical Specifications
 - Typical Performance Plots
 - Typical Performance vs Bias Current at Low frequencies
 - Time Domain Performance Plots
- **Operation**
 - Application Information
- **Mechanical Data**
 - Outline Drawing

Revision History

Revision Code	Revision Date	Comment
-	2010-10-01	Datasheet Initial Release
A	2019-02-01	Corrected Low Frequency plots
B	2020-04-01	Performance vs Bias current plots
C	2020-06-01	Updated Outline Drawing

Port Configuration and Functions

Port Functions

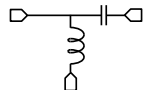
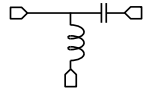
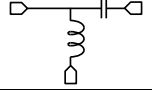
Port	Function	Connector Type	Description	DC Equivalent Circuit
Common	RF+DC	1.85M	This port is DC blocked to the RF port and DC connected to the DC port through an internal RF choke.	
DC	DC	-	This port is internally connected to an RF choke which is DC connected to the RF+DC port and DC blocked to the RF port.	
RF	RF	1.85F	This port is internally DC blocked to the RF+DC and DC ports.	

Specifications

Absolute Maximum Ratings

Parameter	Maximum Rating	Unit
DC Current	0.5	A
DC Voltage	30	V
Maximum Storage Temperature	125	°C
Minimum Storage Temperature	-65	°C
RF Power Handling	1	W

Package Information

Parameter	Details	Rating
Weight	-	23.5g
Dimensions	-	15.24 x 36.07 mm

Electrical Specifications

Specifications guaranteed at +25C, measured in a 50-Ohm system

Parameter	Test Conditions	Minimum Frequency (GHz)	Maximum Frequency (GHz)	Min	Typ	Max	Unit
Capacitance	-	0.000004	65	-	1.1	-	μF
DC Port Isolation	-	0.000004	65	-	30	-	dB
DC Resistance	-	0.000004	65	-	3	-	Ω
Inductance	-	0.000004	65	-	1000	-	μH
Insertion Loss	-	0.000004	65	-	1.8	3	dB
Return Loss	-	0.000004	65	-	12	-	dB
Risetime/Falltime ¹	-	0.000004	65	-	10	-	ps

^[1] Specified as 90%/10%. Calculated from $\mathbb{R}_{bt}^2 = (\mathbb{R}_{out}^2 - \mathbb{R}_{in}^2)$

Typical Performance Plots

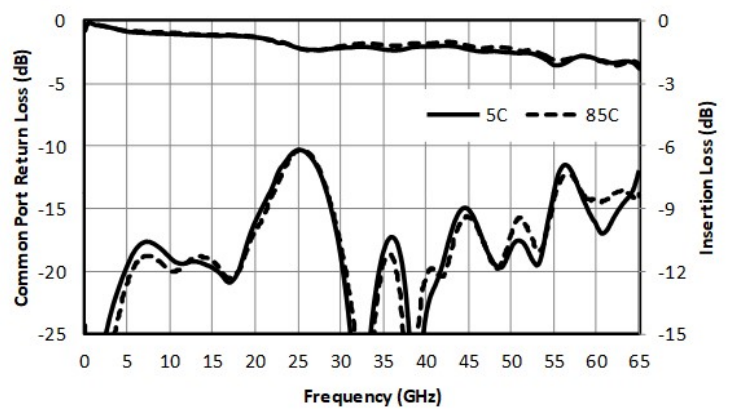
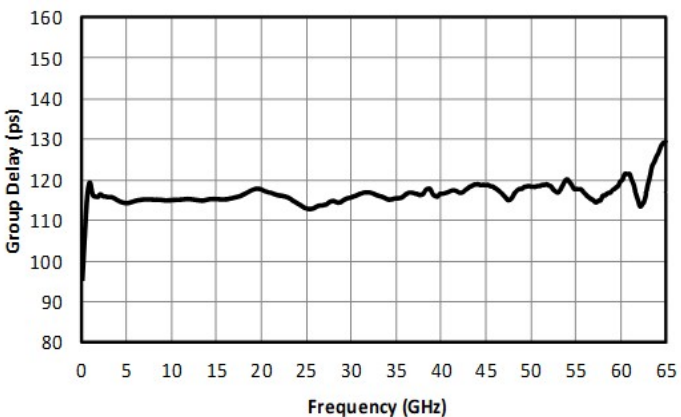
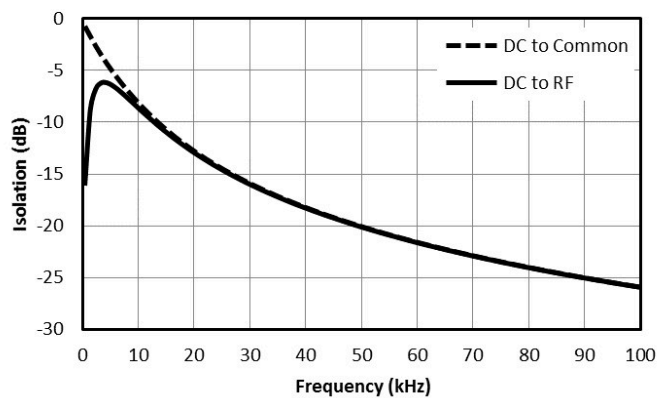
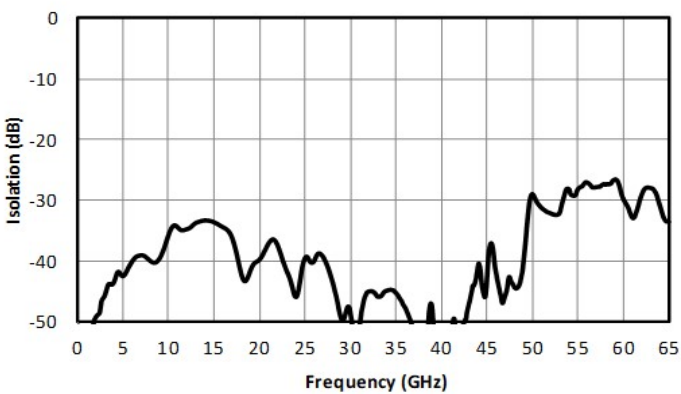
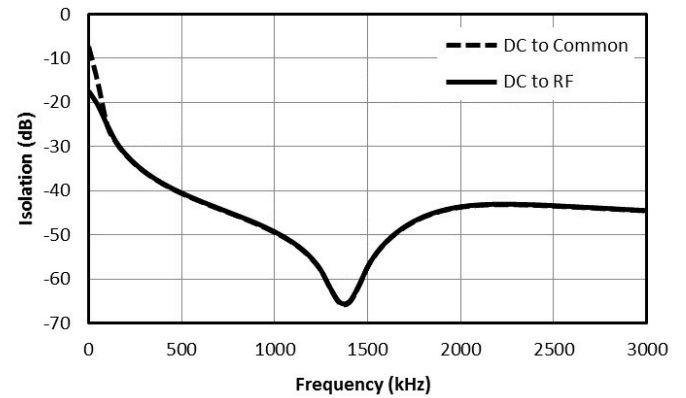
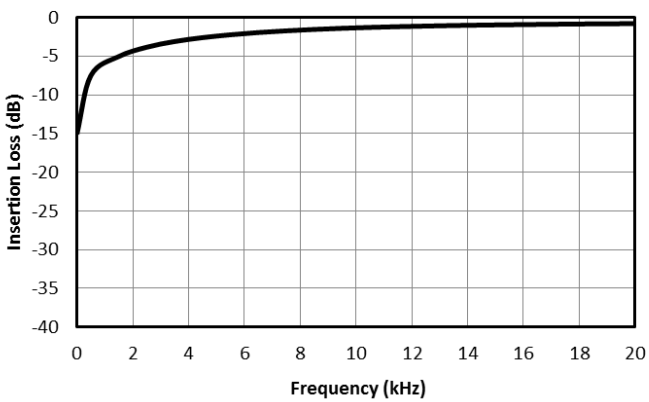
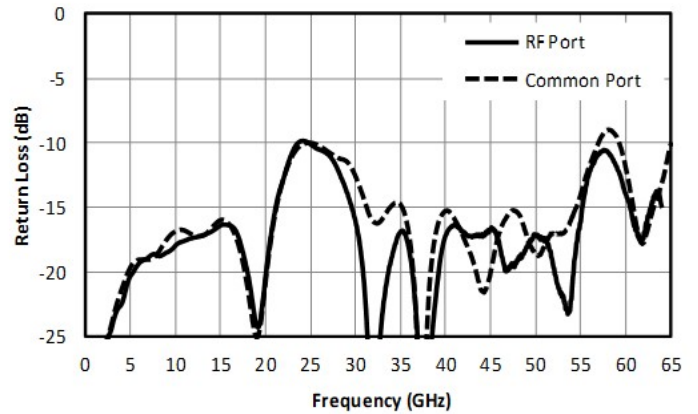
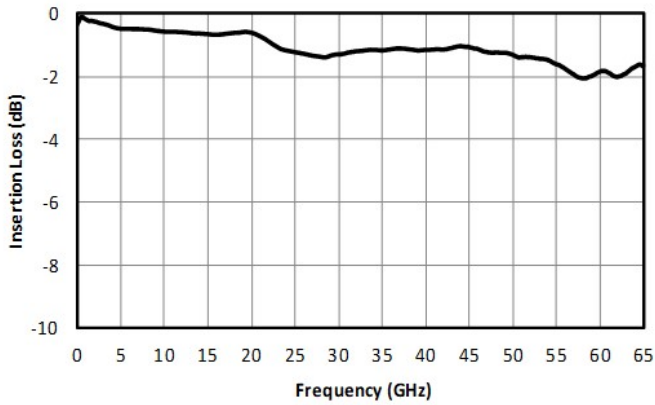

Typical Performance vs Bias Current at Low frequencies

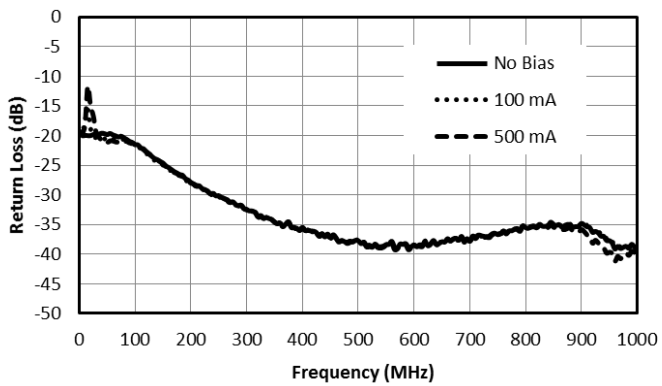
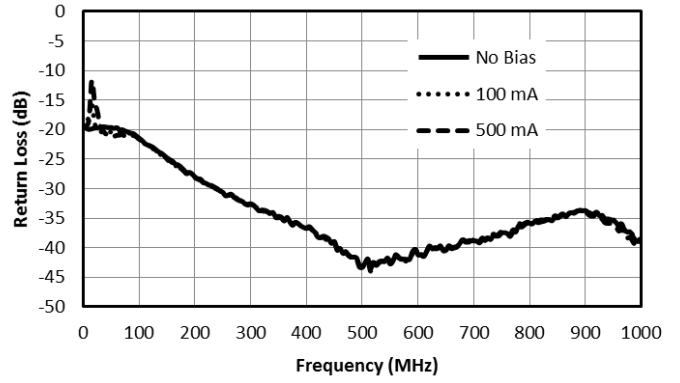
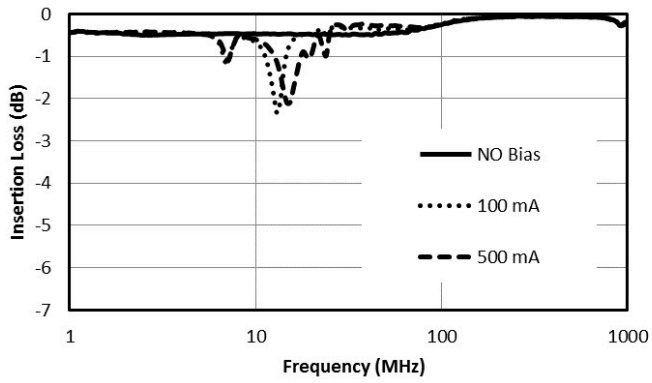

Time Domain Performance Plots

Oscilloscope measurements of the BT-0065 with a 10Gb/s PRBS pattern. Eye diagrams are taken with a $2^{31}-1$ PRBS input demonstrating minimal eye distortion/closure afforded by the extremely low frequency operation of the bias tee.

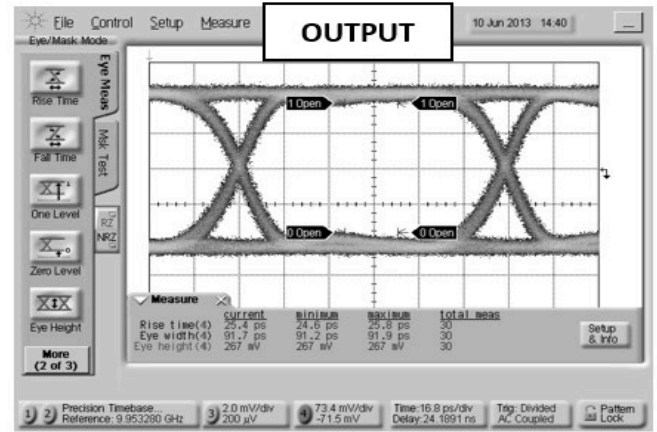
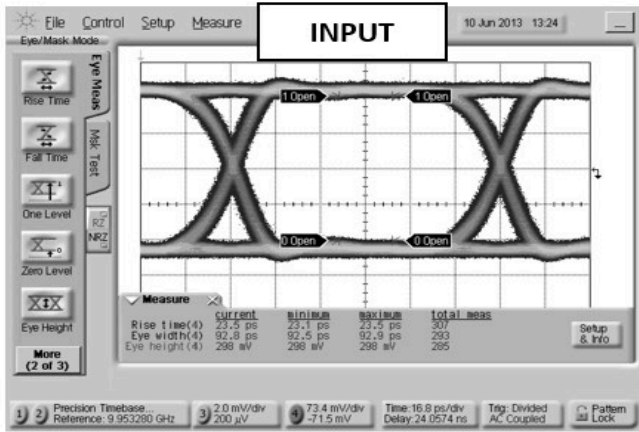

Application Information

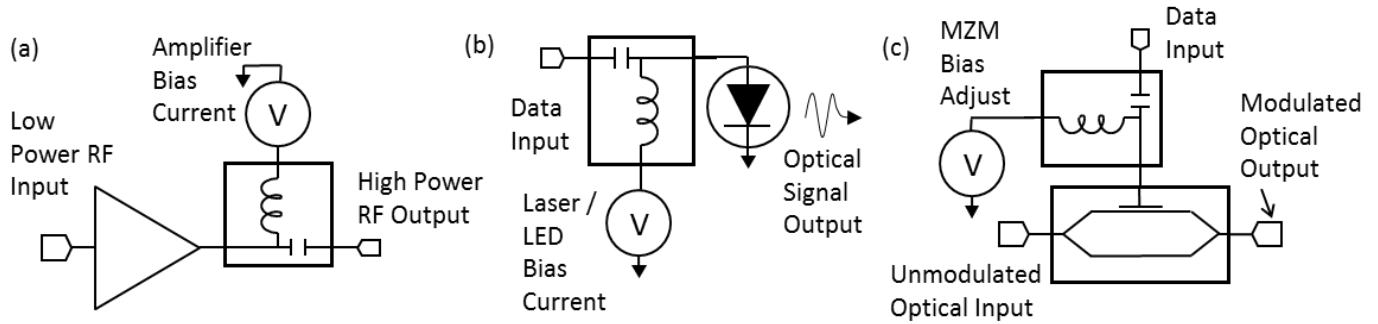

Example Schematics of a) Broadband Microwave Amplifier Biasing, b) Laser/LED Biasing for Data Communication and c) Mach-Zender Modulator Biasing for Data Communication.

Mechanical Data

Outline Drawing

Download : [Outline 2D Drawing](#) | [Outline 3D Drawing](#) | [Outline 3D STP](#)

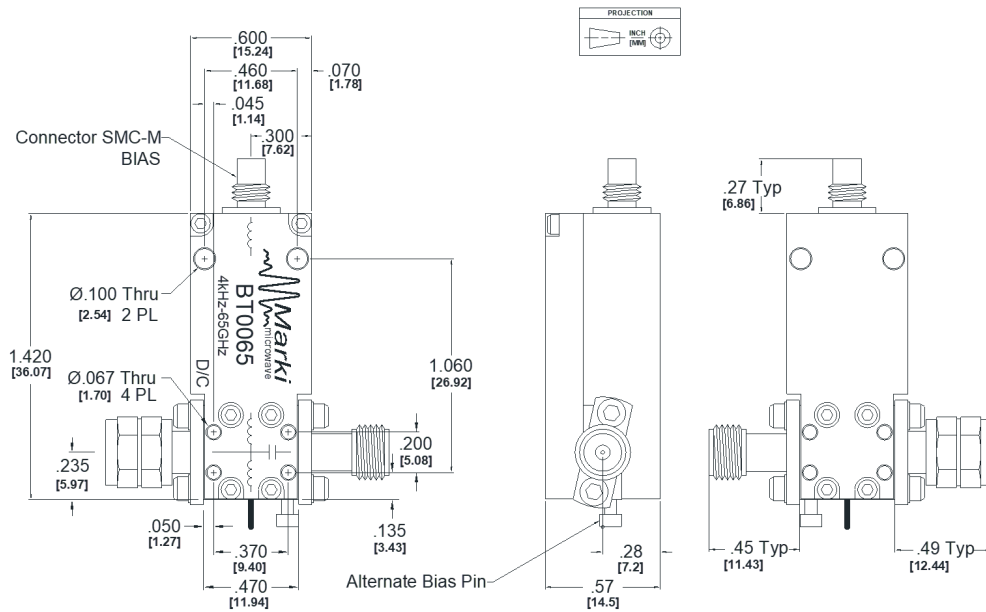

Port	Connector Type
Bias	1.85 mm Male
RF in	1.85 mm Female
Note: Bias-Tee Connectors are not removeable.	

DISCLAIMER

MARKI MICROWAVE, INC., ("MARKI") PROVIDES TECHNICAL SPECIFICATIONS AND DATA (INCLUDING DATASHEETS), APPLICATION OR OTHER DESIGN ADVICE, WEB TOOLS, AND OTHER INFORMATION AND RESOURCES "AS IS" AND WITH ALL FAULTS. MARKI DISCLAIMS ALL WARRANTIES, EXPRESS OR IMPLIED, INCLUDING, WITHOUT LIMITATION, ANY IMPLIED WARRANTIES OF MERCHANTABILITY, FITNESS FOR A PARTICULAR PURPOSE, OR NON-INFRINGEMENT.

These resources are intended for developers skilled in the art designing with Marki products. You are solely responsible for (1) selecting the appropriate products for your application, (2) designing, validating, and testing your application, and (3) ensuring your application meets applicable standards and other requirements. Marki makes no guarantee regarding the suitability of its products for any particular purpose, nor does Marki assume any liability whatsoever arising out of your use or application of any Marki product.

Marki grants you permission to use these resources only for development of an application that uses Marki products. Other reproduction or use of these resources is strictly prohibited. No license is granted to any other Marki intellectual property or to any third-party intellectual property. Marki reserves the right to make changes to the product(s) or information contained herein without notice.

MARKI MICROWAVE and T3 MIXER are trademarks or registered trademarks of Marki Microwave, Inc. All other trademarks used are the property of their respective owners.

© 2010, 2019 - 2020, Marki Microwave, Inc