

ADM-10701PSM

2-20 GHz Broadband, Low DC Power, Low Noise Amplifier

DEVICE OVERVIEW

General Description

The ADM-10701PSM is a broadband low noise amplifier covering 2 GHz to 20 GHz. Optimized for ultra-low power consumption in compact systems, it operates from a single 2 V supply at just 15 mA bias current, providing 13 dB of small-signal gain with a typical noise figure of 2.4 dB. The ADM-10701PSM requires no application circuit other than bypass capacitors on the DC supply lines, which simplifies integration and reduces board space. Packaged in a compact 3 mm QFN, it is well suited for wideband front-end applications that demand low power, moderate gain, and minimal added noise. Measured small-signal S-parameters are available to support accurate system simulation.

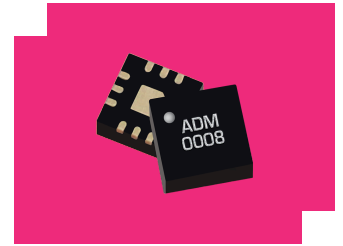

Features

- Broadband Operation, 2 to 20 GHz
- Low Noise Figure, 2.4 dB Typical
- Low DC Power Consumption, +2 V at 15 mA
- Single Supply Voltage
- Small 3x3mm QFN Package

Applications

- SATCOM
- Phased array systems

Functional Block Diagram

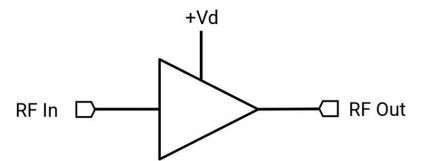

Part Ordering Options

Part Number	Description	Package	Green Status	Product Lifecycle	Export Classification
ADM-10701PSM	2-20 GHz Broadband, Low DC Power, Low Noise Amplifier	Plastic QFN	REACH RoHS	Released	EAR99
EVB-ADM-10701P	Evaluation Board, 2 - 20 GHz Broadband Low Power Low Noise Amplifier	EVB	REACH RoHS	Released	EAR99

ADM-10701PSM

2-20 GHz Broadband, Low DC Power, Low Noise Amplifier

Table Of Contents

- **Device Overview**
 - General Description
 - Features
 - Applications
 - Functional Block Diagram
- **Port Configuration and Functions**
 - Port Diagram
 - Port Functions
- **Revision History**
- **Specifications**
 - Absolute Maximum Ratings
 - Package Information
 - Recommended Operating Conditions
 - Sequencing Requirements
 - Electrical Specifications
 - Typical Performance Plots (vs Bias)
 - Typical Performance Plots (vs Temperature)
- **Operation**
 - Application Information
 - Application Circuit
 - Application Circuit Description
- **Mechanical Data**
 - Outline Drawing
- **Footprint Image**
- **Evaluation Board**
 - Evaluation Board Outline Drawing

Revision History

Revision Code	Revision Date	Comment
-	2025-10-20	Initial Release

Port Configuration and Functions

Port Diagram

Below is the recommended application circuit for the ADM-10701PSM. This is the configuration that is used to characterize this device. However, each PCB layout and environment are different which may require minor modifications of the biasing network. Please contact support@markimicrowave.com for more information.

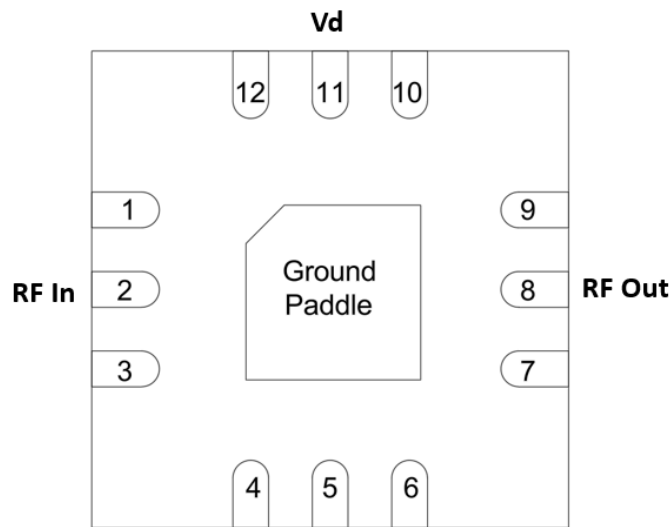

Port Functions

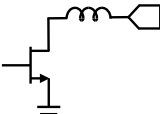
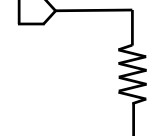
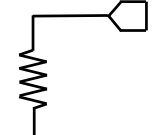
Port	Function	Description	DC Equivalent Circuit
GND	Ground	Ground paddle and non-connected pins must be connected to a DC/RF ground potential with high thermal and electrical conductivity, and low inductance.	
Pin 11	Vd	Pin 11 is the DC bias supply for the amplifier. The voltage at this pin should be set to 2V for normal operation. This part requires an off-chip bypass capacitor of 0.1uF installed at this pin as close to the IC as possible. See applications circuit.	
Pin 1,3,4,5,6,7,9,10,12	Ground	These pins are not internally connected to the amplifier die. It is recommended to connect these pins to ground to provide RF isolation and mechanical stability. See the recommended landing pattern for details. Datasheet performance was measured with these pins connected to GND.	-
Pin 2	RF Input	Pin 2 is the amplifier's RF input pin. This port is internally matched to 50 Ohms and is internally DC shorted to GND. This pin may be left floating if no DC is present on the line but should be DC blocked otherwise.	
Pin 8	RF Output	Pin 8 is the amplifier's RF output pin. This port is internally matched to 50 Ohms and is internally DC shorted to GND. This pin may be left floating if no DC is present on the line but should be DC blocked otherwise.	

Specifications

Absolute Maximum Ratings

The Absolute Maximum Ratings indicate limits beyond which damage may occur to the device. If these limits are exceeded, the device may be inoperable or have a reduced lifetime. This amplifier is designed and characterized in a 50Ω system, and operation in a reflective environment can cause performance degradation.

Parameter	Maximum Rating	Unit
Maximum Operating Temperature	85	°C
Maximum Storage Temperature	150	°C
Max Junction Temperature for MTTF > 1E6 hours	175	°C
Minimum Operating Temperature	-40	°C
Minimum Storage Temperature	-65	°C
Positive Drain Supply Current (with RF Input)	60	mA
Positive Drain Supply Voltage (Vd)	6	V
RF Input Power	10	dBm
Thermal Resistance, θ_{JC} ¹	100	°C/W

[1] TBD

Package Information

Parameter	Details	Rating
ESD	250 to < 500 Volts	HBM Class 1A
Dimensions	-	3 x 3 mm
Moisture Sensitivity Level	-	MSL 1

Recommended Operating Conditions

The Recommended Operating Conditions indicate the limits, inside which the device should be operated, to guarantee the performance given in Electrical Specifications. Operating outside these limits may not necessarily cause damage to the device, but the performance may degrade outside the limits of the Electrical Specifications. For limits, above which damage may occur, see Absolute Maximum Ratings .

Parameter	Min	Nominal	Max	Unit
Ambient Temperature	-40	25	85	°C
Power Supply DC Voltage	2	2	5	V
Positive DC Current (Id) (No RF Input)	15	15	49	mA

Sequencing Requirements

There are no sequencing requirements to power up or power down the amplifier.

Electrical Specifications

The electrical specifications apply at TA=+25°C in a 50Ω system. QFNs are 100% RF tested.

Parameter	Test Conditions	Minimum Frequency (GHz)	Maximum Frequency (GHz)	Min	Typ	Max	Unit
Small Signal Gain	2V bias, -30 dBm Input Power	2	20	-	13	-	dB
Input Return Loss	2V bias, -30 dBm Input Power	2	20	-	11	-	dB
Output Return Loss	2V bias, -30 dBm Input Power	2	20	-	13	-	dB
Reverse Isolation	2V bias, -30dBm Input Power	2	20	-	19	-	dB
Noise Figure	2V bias, -30 dBm Input Power	2	20	-	2.4	-	dB
Output P1dB	2V bias	2	20	-	6.2	-	dBm
Output IP3	2V bias	2	20	-	18	-	dBm
Current Consumption ¹	2V bias	-	-	-	15	-	mA

^[1] Bias conditions for Id tested with no RF input power. Bias conditions presented as Vd.

Typical Performance Plots (vs Bias)

Measurement data de-embedded using standard evaluation board and external wideband test equipment bias tees.

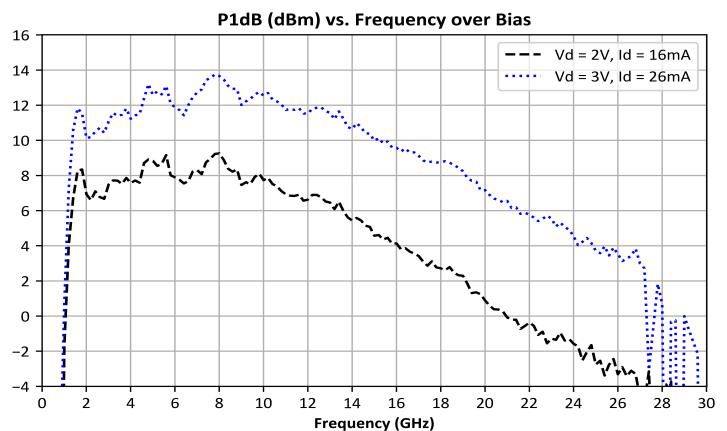
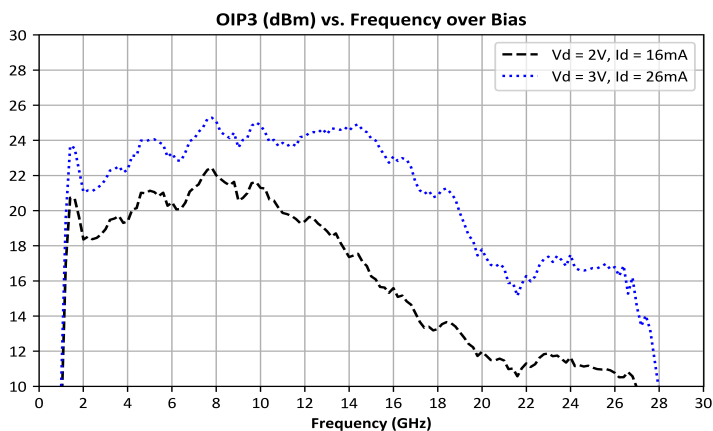
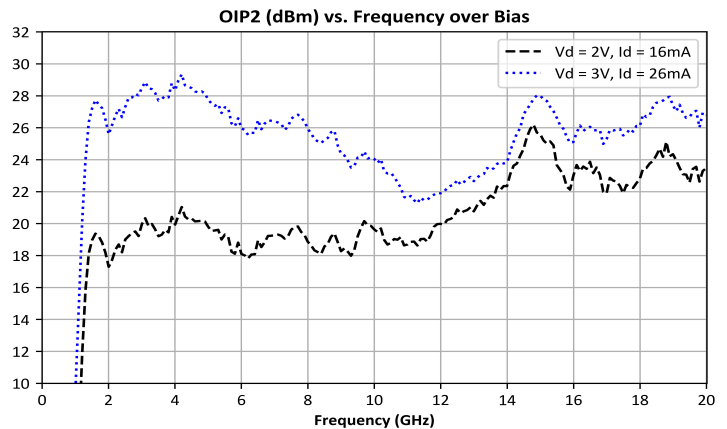
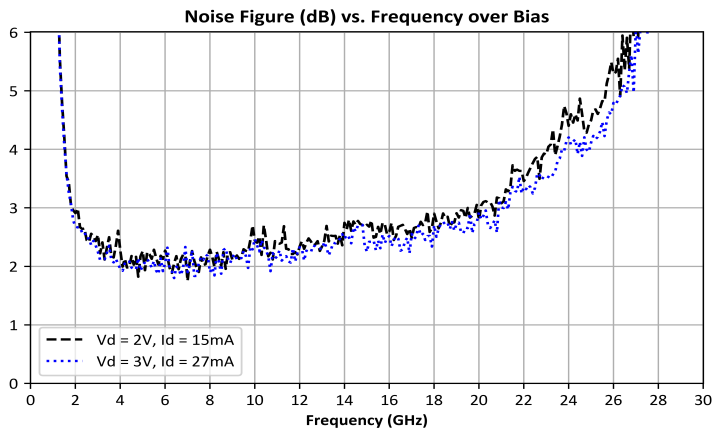
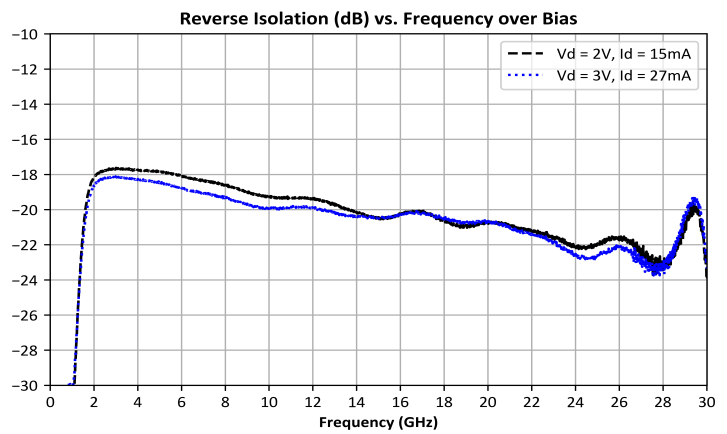
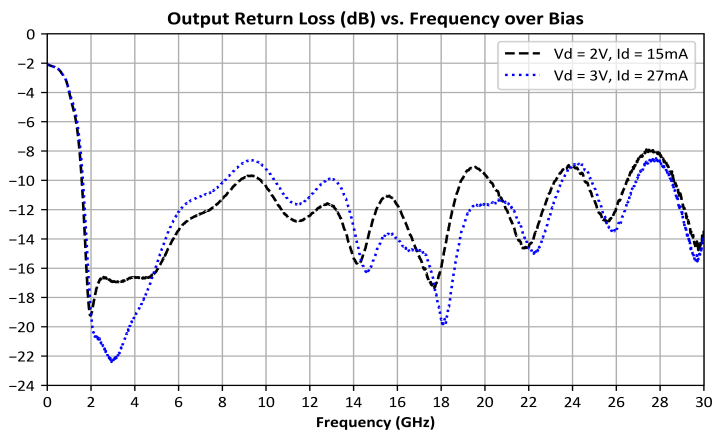
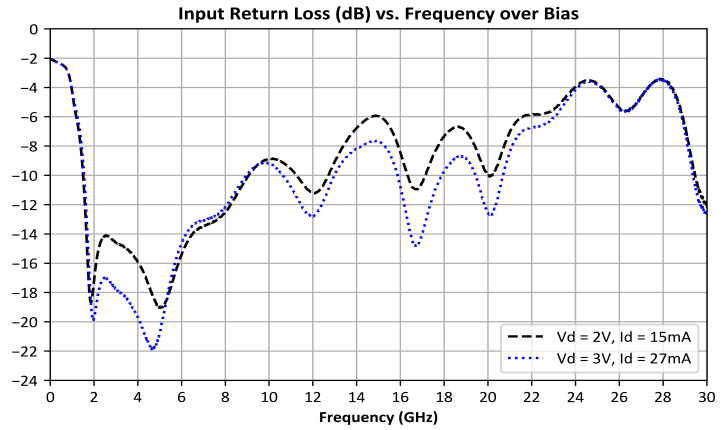
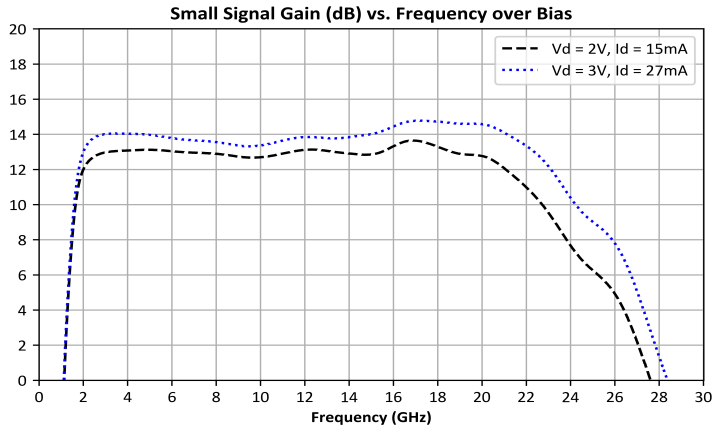

ADM-10701PSM

2-20 GHz Broadband, Low DC Power, Low Noise Amplifier

Typical Performance Plots (vs Temperature)

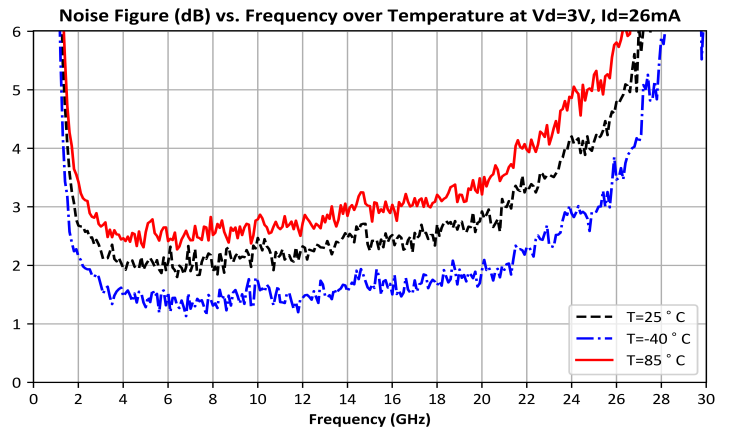
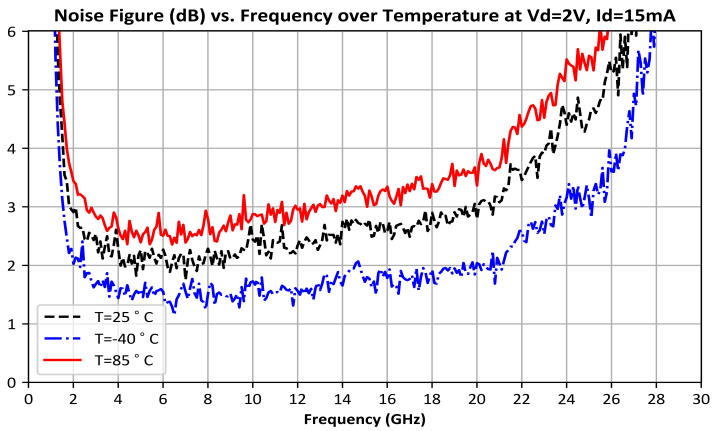
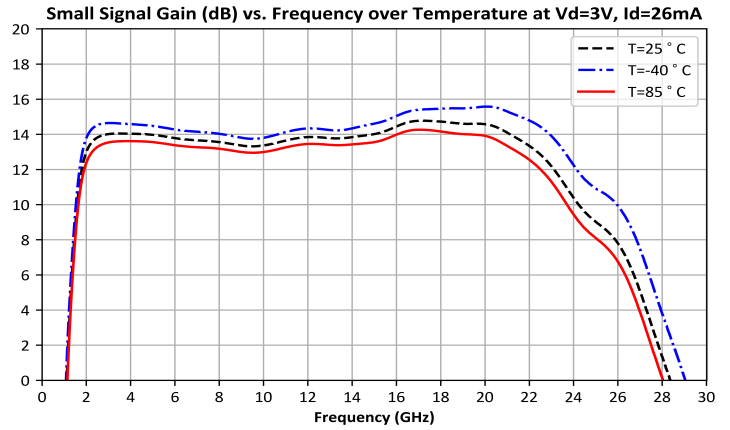
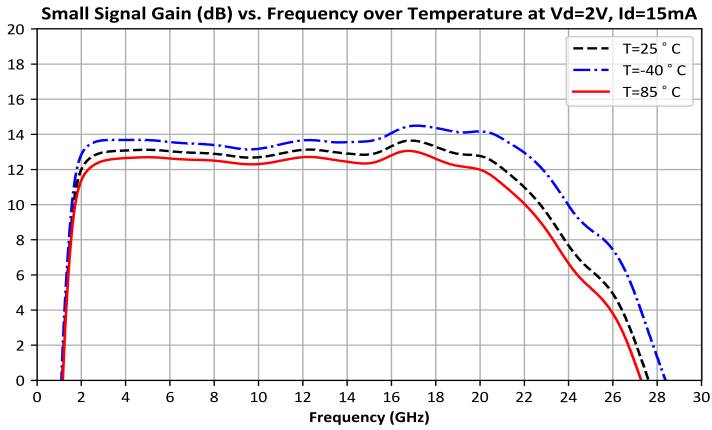

ADM-10701PSM

2-20 GHz Broadband, Low DC Power, Low Noise Amplifier

Application Information

Below is the recommended application circuit for the ADM-10701PSM. This is the configuration that is used to characterize this device. However, each PCB layout and environment are different which may require minor modifications of the biasing network. Please contact support@markimicrowave.com for more information.

ADM-10701PSM

2-20 GHz Broadband, Low DC Power, Low Noise
Amplifier

Application Circuit

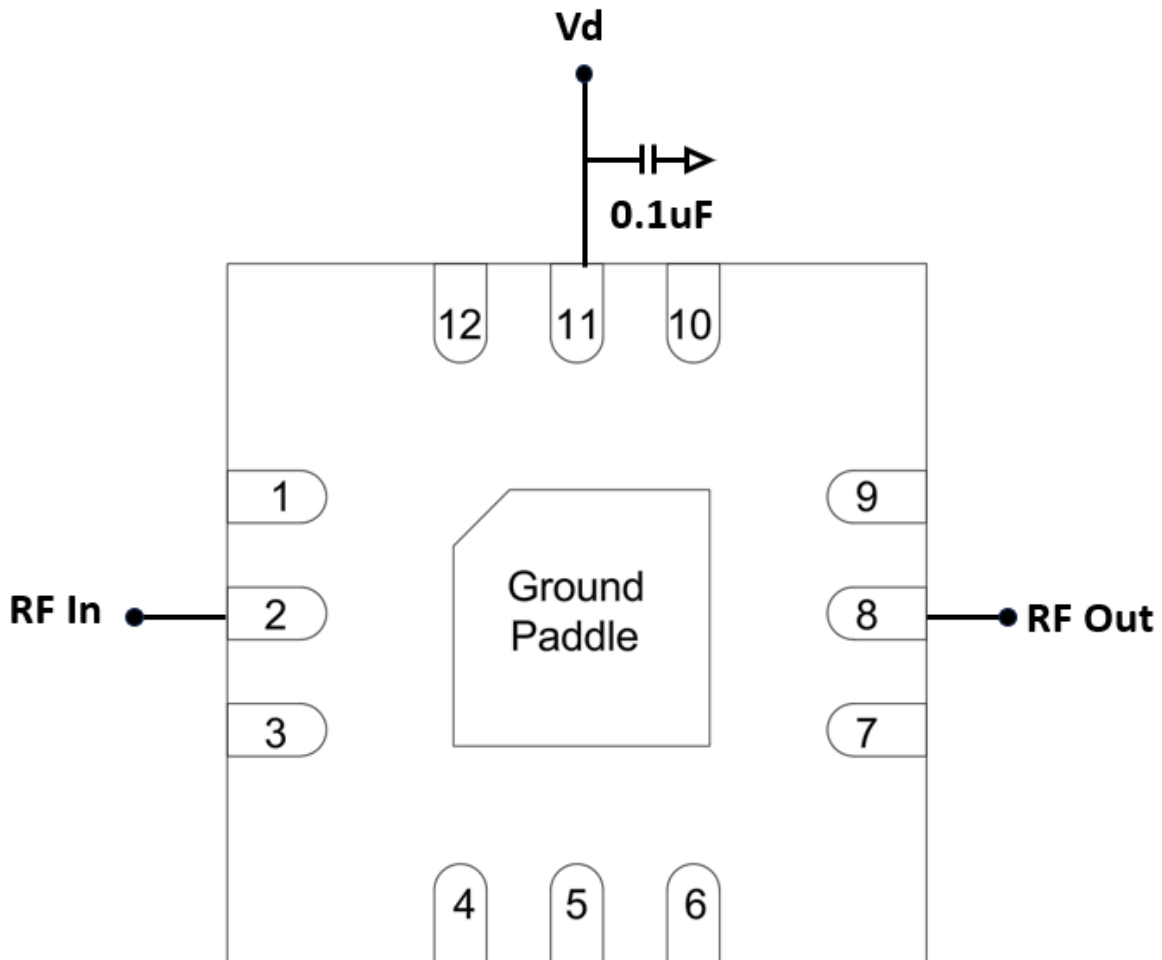

ADM-10701PSM

2-20 GHz Broadband, Low DC Power, Low Noise
Amplifier

Application Circuit Description

Above is the recommended application circuit for the ADM-10701PSM. DC drain voltage is supplied to the amplifier across a 0.1uF bypass capacitor to the Vd pin. The RF input and output ports are internally shorted to GND but can be left floating if no DC is present on the RF line. If DC is present, blocking capacitors are required at the input and output.

ADM-10701PSM

2-20 GHz Broadband, Low DC Power, Low Noise Amplifier

Mechanical Data

Outline Drawing

Download : [Outline 2D Drawing](#)

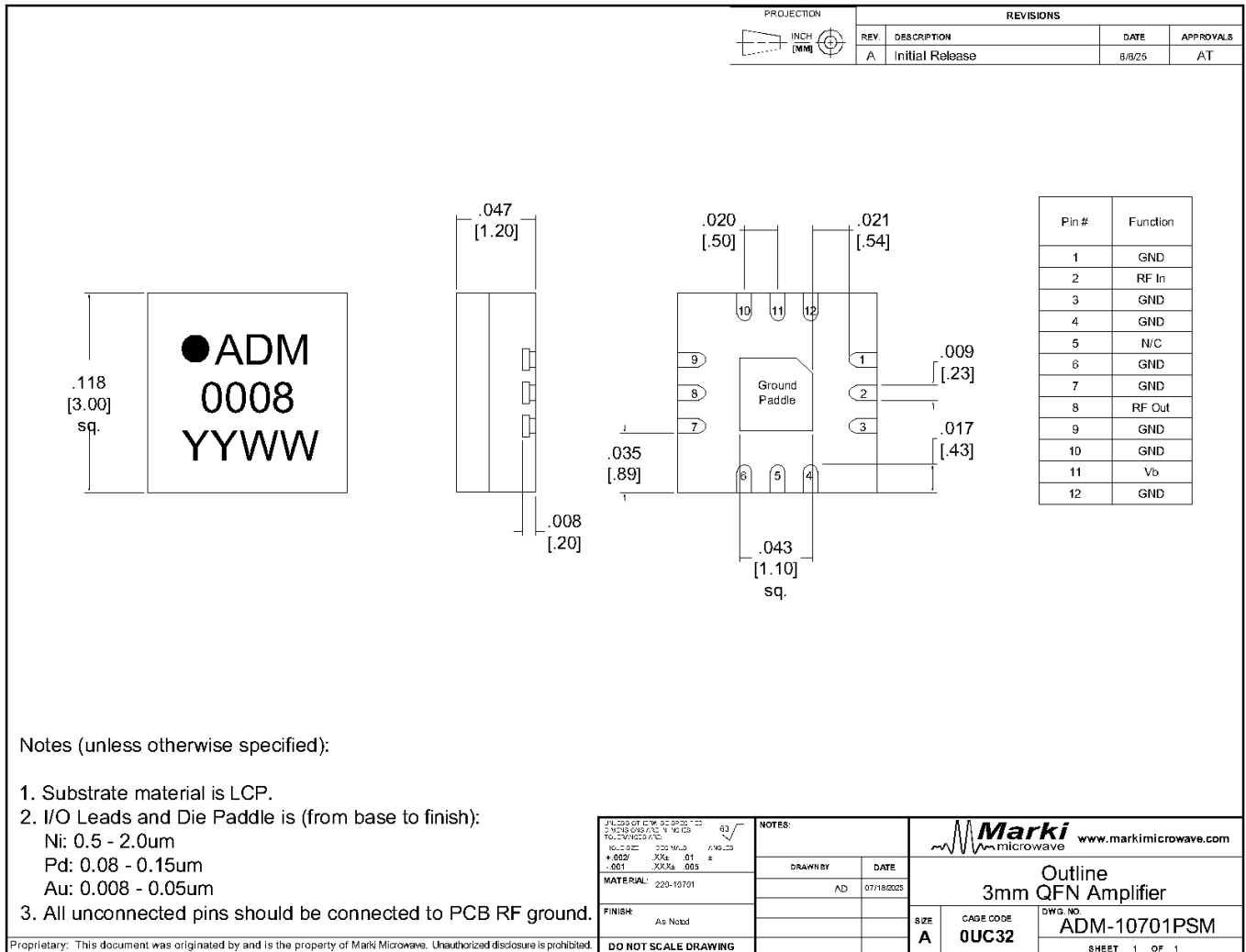

ADM-10701PSM

2-20 GHz Broadband, Low DC Power, Low Noise Amplifier

Footprint Image

Download : [Footprint Drawing](#)

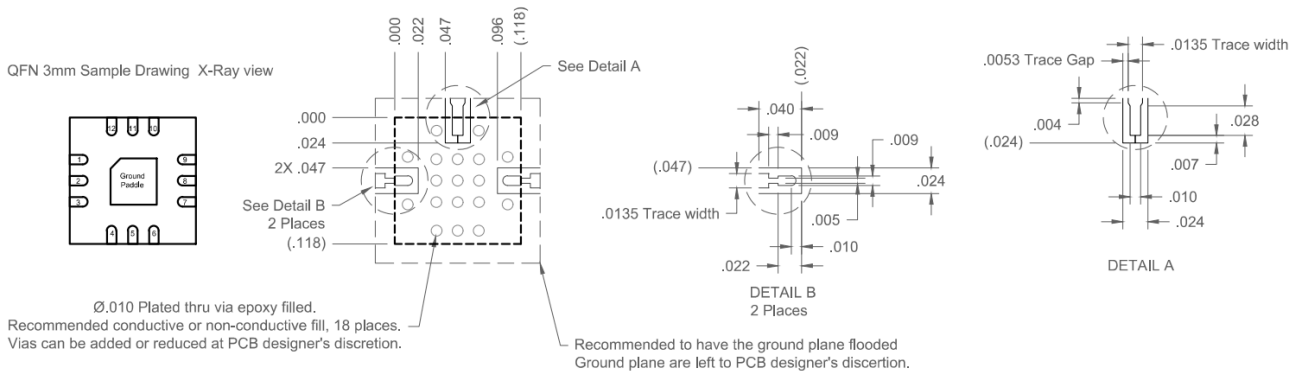

The landing pattern is to be used on Rogers 4003,
0.008" thick, ½ Oz Cu.

ADM-10701PSM

2-20 GHz Broadband, Low DC Power, Low Noise Amplifier

Evaluation Board - Outline Drawing

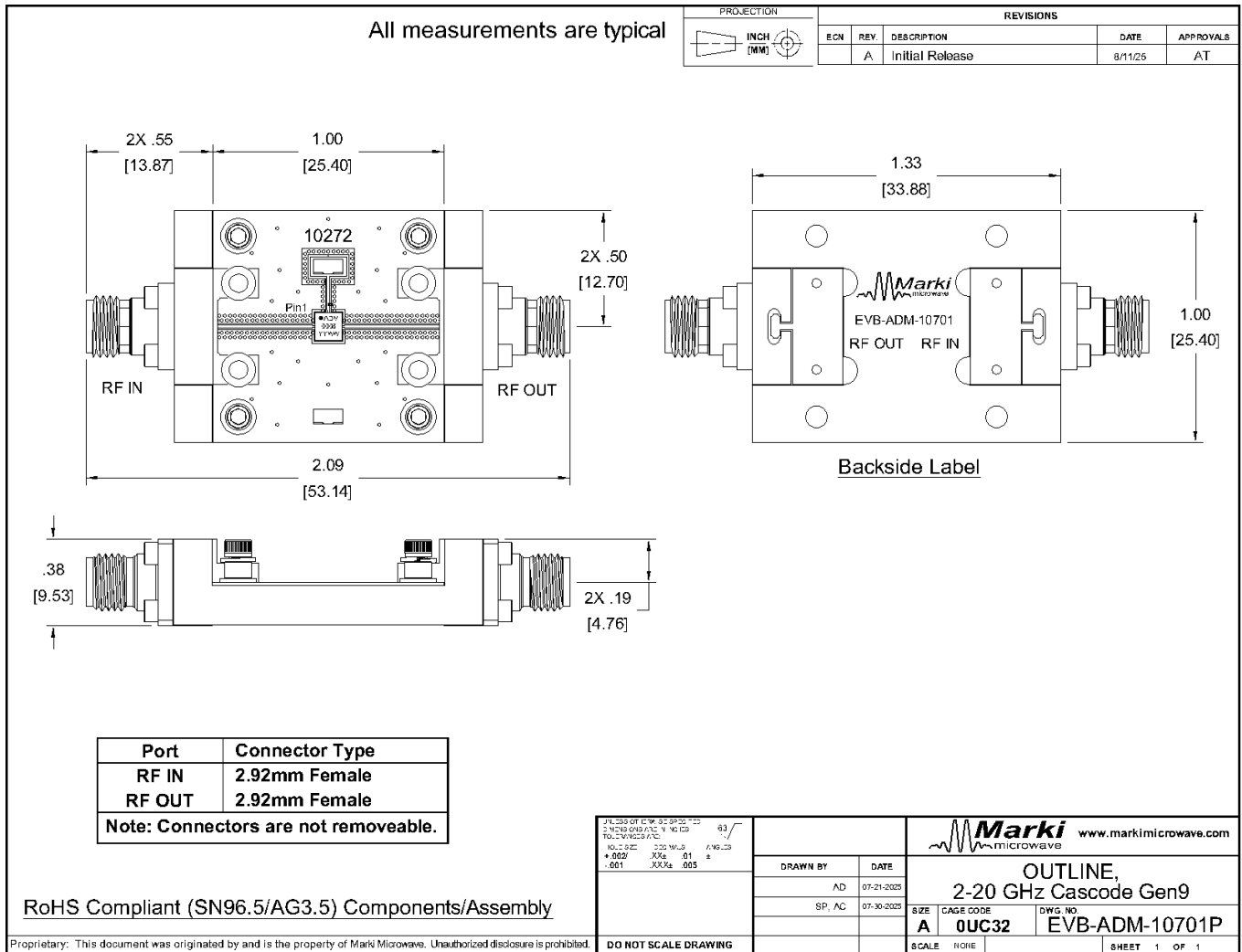

ADM-10701PSM

2-20 GHz Broadband, Low DC Power, Low Noise Amplifier

DISCLAIMER

MARKI MICROWAVE, LLC., ("MARKI") PROVIDES TECHNICAL SPECIFICATIONS AND DATA (INCLUDING DATASHEETS), APPLICATION OR OTHER DESIGN ADVICE, WEB TOOLS, AND OTHER INFORMATION AND RESOURCES "AS IS" AND WITH ALL FAULTS. MARKI DISCLAIMS ALL WARRANTIES, EXPRESS OR IMPLIED, INCLUDING, WITHOUT LIMITATION, ANY IMPLIED WARRANTIES OF MERCHANTABILITY, FITNESS FOR A PARTICULAR PURPOSE, OR NON-INFRINGEMENT.

These resources are intended for developers skilled in the art designing with Marki products. You are solely responsible for (1) selecting the appropriate products for your application, (2) designing, validating, and testing your application, and (3) ensuring your application meets applicable standards and other requirements. Marki makes no guarantee regarding the suitability of its products for any particular purpose, nor does Marki assume any liability whatsoever arising out of your use or application of any Marki product.

Marki grants you permission to use these resources only for development of an application that uses Marki products. Other reproduction or use of these resources is strictly prohibited. No license is granted to any other Marki intellectual property or to any third-party intellectual property. Marki reserves the right to make changes to the product(s) or information contained herein without notice.

MARKI MICROWAVE and T3 MIXER are trademarks or registered trademarks of Marki Microwave, LLC. All other trademarks used are the property of their respective owners.

© 2025, Marki Microwave, LLC