

T3-12MCQG-1

Two-Tone-Terminator Mixer

DEVICE OVERVIEW

General Description

The T3-12 is a high performance mixer featuring LO/RF from 10 MHz to 12 GHz and IF from 1 MHz to 4 GHz. As with all T3 mixers, this mixer offers unparalleled nonlinear performance in terms of IIP3, P1dB, and spurious performance with a flexible LO drive requirement from +15 dBm to +27 dBm. The T3-12 is offered in connectorized, surface mount, and drop-in style packaging, suitable for any type of system level integration.

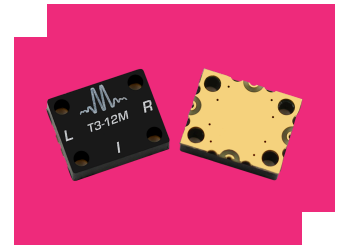

Features

- Ultra-Broadband RF, LO, and IF
- Compatible with Sine or Square-Wave LO
- Square-Wave LO delivers Industry-Leading Spurious, IP3, and P_{1dB} Performance

Applications

N/A

Functional Block Diagram

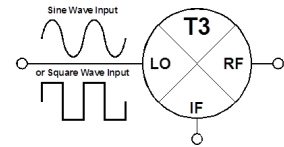

Part Ordering Options

Part Number	Description	Package	Green Status	Product Lifecycle	Export Classification
T3-12MCQG-1	Two-Tone-Terminator Mixer	CQG	REACH RoHS	Released	EAR99
<u>T3-12LCQG-1</u>	Two-Tone-Terminator Mixer	CQG	REACH RoHS	Released	EAR99
<u>T3-12LCQG-2</u>	Two-Tone-Terminator Mixer	CQG	REACH RoHS	Released	EAR99
<u>T3-12MCQG-2</u>	Two-Tone-Terminator Mixer	CQG	REACH RoHS	Released	EAR99

Table Of Contents

- **Device Overview**
 - General Description
 - Features
 - Applications
 - Functional Block Diagram
- **Port Configuration and Functions**
 - Port Diagram
 - Port Functions
- **Revision History**
- **Specifications**
 - Absolute Maximum Ratings
 - Package Information
 - Recommended Operating Conditions
 - Electrical Specifications
 - Typical Performance Plots
 - Spur Tables
- **Mechanical Data**
 - Outline Drawing
- **Notes**

Revision History

Revision Code	Revision Date	Comment
-	2008-01-01	Initial Release
A	2018-12-01	Removed Leaded Surface Mount CQ package
B	2021-10-01	Updated SMT Package Outlines

Port Configuration and Functions

Port Diagram

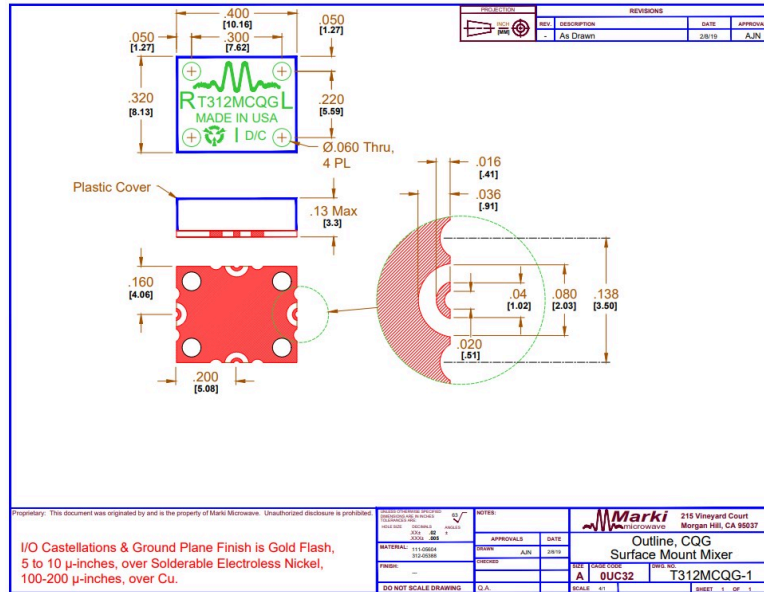

Port Functions

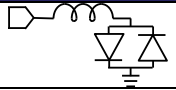
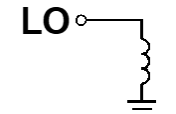
Port	Function	Description	Equivalent Circuit for Package
IF	IF	The IF port is DC blocked and AC matched to 50 Ohms from 1 MHz to 4 GHz.	
LO	LO	The LO port is DC short to ground and AC matched to 50 Ohms from 10 MHz to 12 GHz. Blocking capacitor is optional.	
RF	RF	The RF port is DC short to ground and AC matched to 50 Ohms from 10 MHz to 12 GHz. Blocking capacitor is optional.	-

Specifications

Absolute Maximum Ratings

Parameter	Maximum Rating	Unit
LO DC Current	1	Amp
Maximum Operating Temperature	100	°C
Maximum Storage Temperature	125	°C
Minimum Operating Temperature	-55	°C
Minimum Storage Temperature	-65	°C
RF DC Current	1	Amp
RF Power Handling (RF+LO)	27	dBm

Package Information

Parameter	Details	Rating
ESD	250 to < 500 Volts	HBM Class 1A
Dimensions	-	10.16 x 8.13 mm
Moisture Sensitivity Level	-	MSL 1

Recommended Operating Conditions

Parameter	Min	Nominal	Max	Unit
LO Input Power	17	-	27	-

Electrical Specifications

Specifications guaranteed from -55 to +100°C, measured in a 50Ω system.

Parameter	Test Conditions	Min	Typ	Max	Unit
Conversion Loss	LO/RF=.01-12GHz IF=.001-0.5GHz	-	7.5	10	dB
Conversion Loss	LO/RF=.01-12GHz IF=.001-4.0GHz	-	8.5	12	dB
IF Frequency Range	-	0.001	-	4	GHz
LO Frequency Range	-	0.01	-	12	GHz
RF Frequency Range	-	0.01	-	12	GHz
Input IP3	-	-	30	-	dBm
Isolation, LO to RF	-	-	30	-	dB

Typical Performance Plots

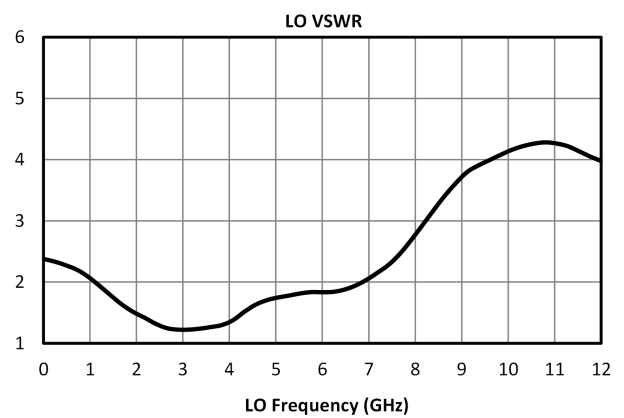
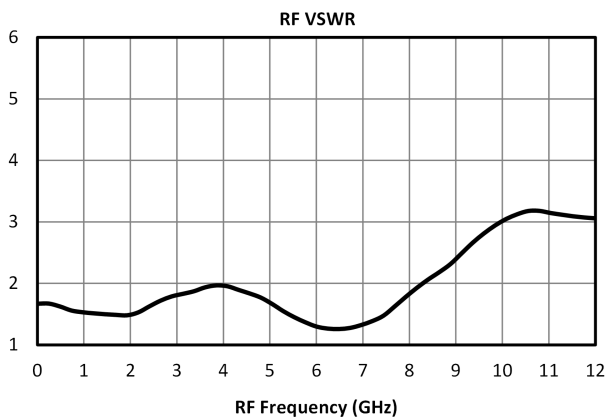
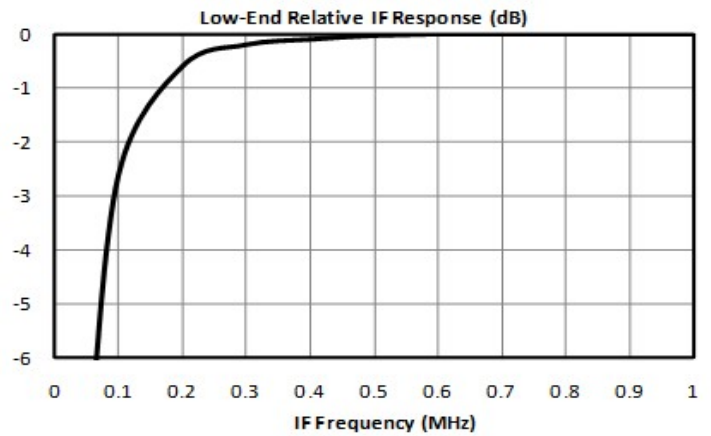
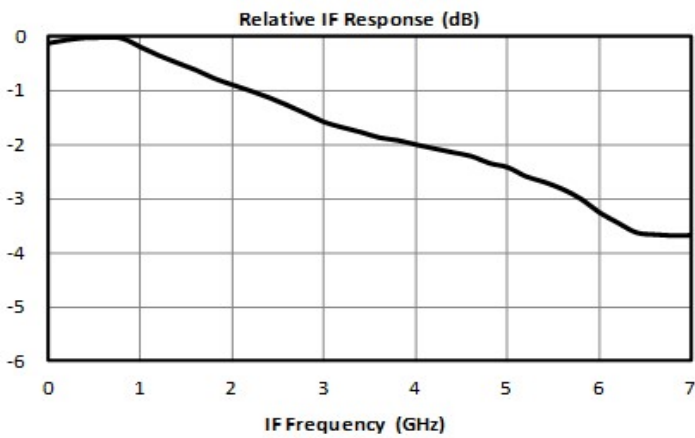
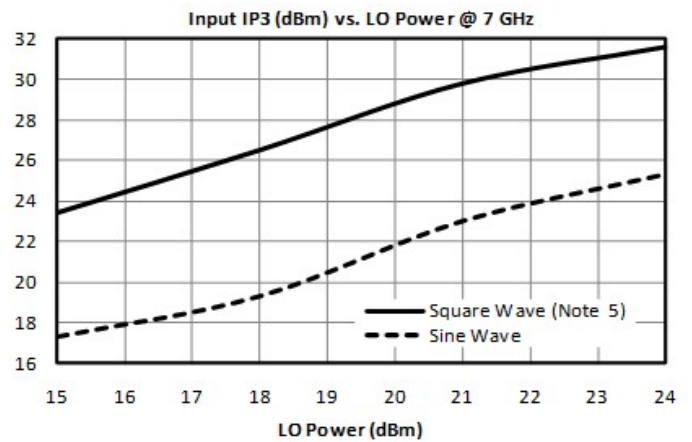
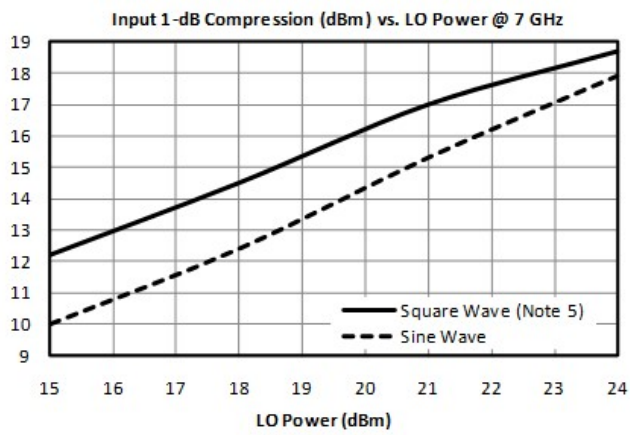
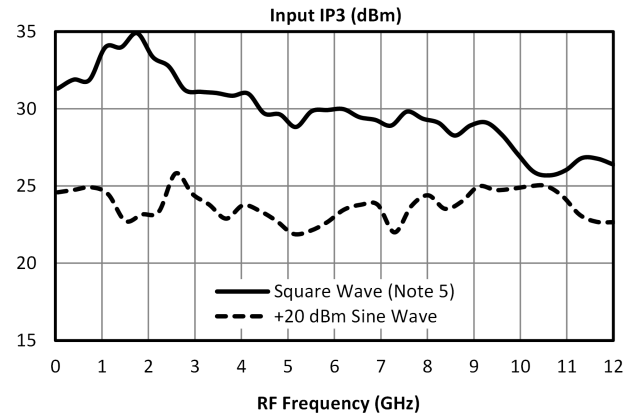
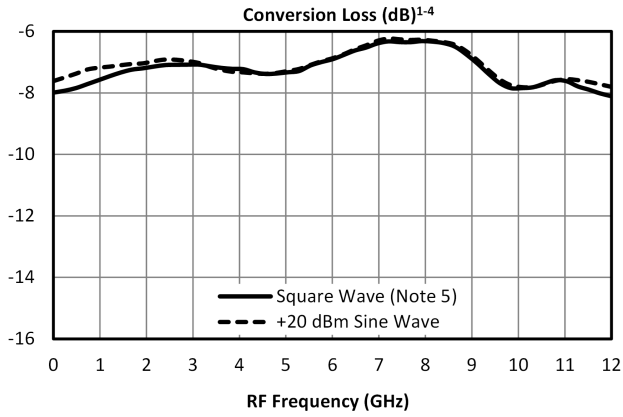

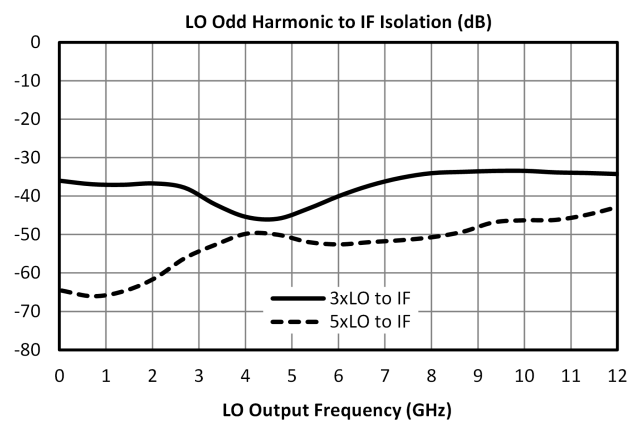
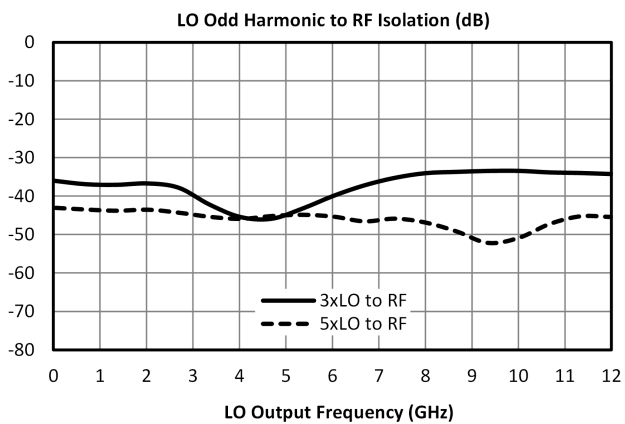
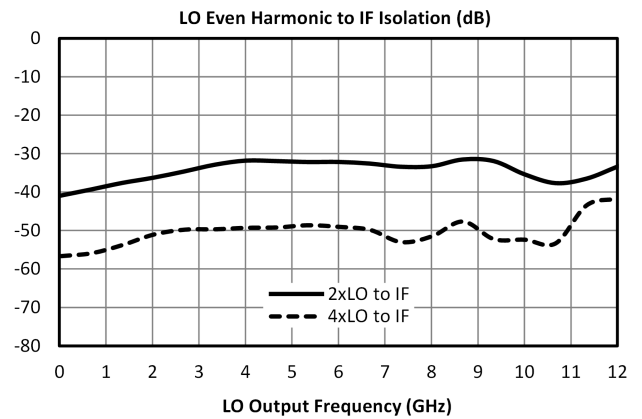
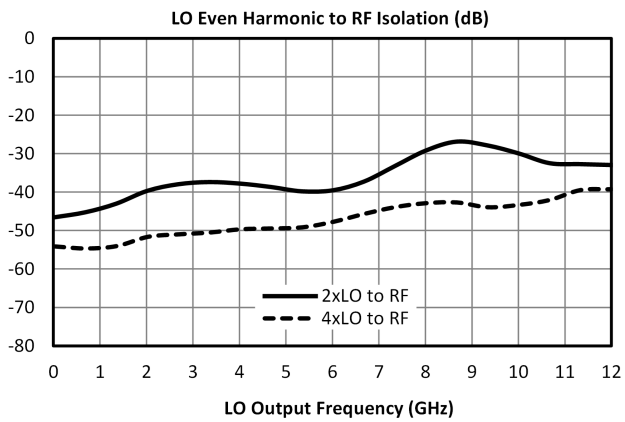
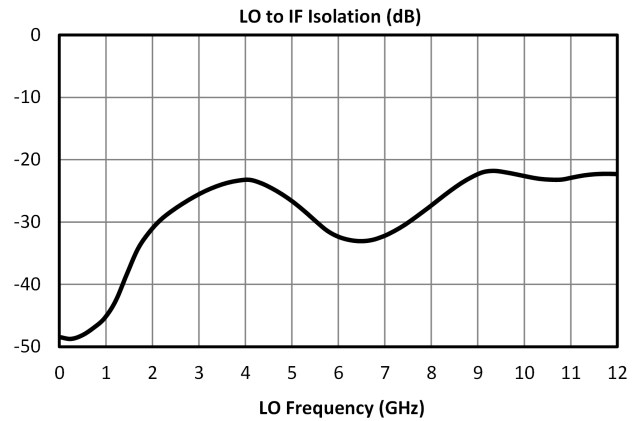
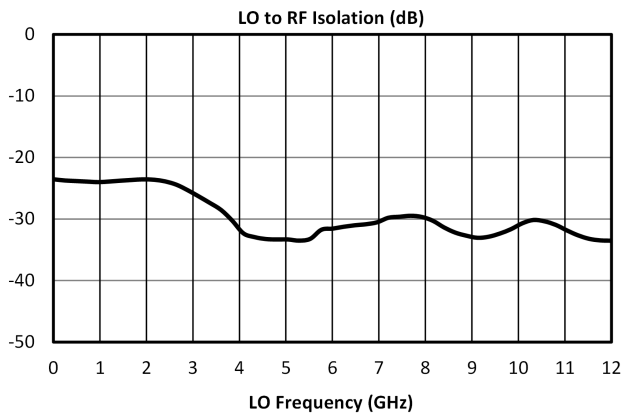
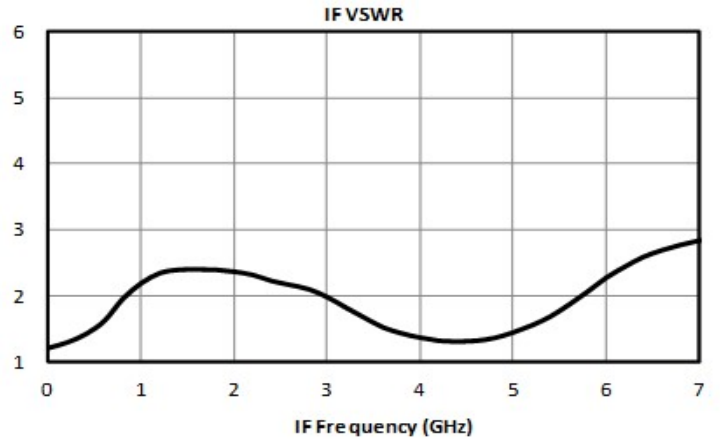
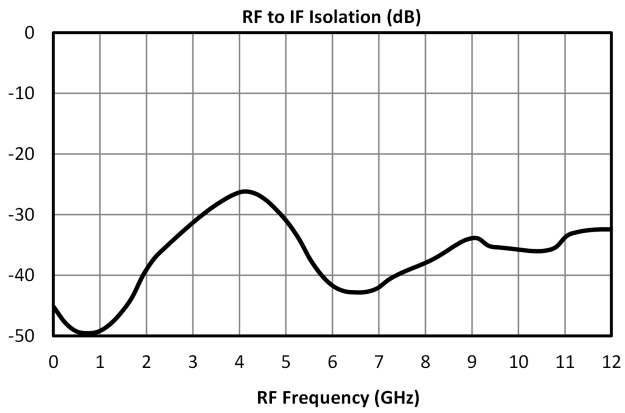

Spur Table

Spurious data is taken by selecting RF and LO frequencies (+mLO+nRF) within the 10 MHz to 12 GHz RF/LO bands, which create a 100 MHz IF spurious output. The mixer is swept across the full spurious band and the mean is calculated. The numbers shown in the table below are for a -10 dBm RF input. Spurious suppression is scaled for different RF power levels by (n-1), where “n” is the RF spur order. For example, the 2RFx2LO spur is 67 dBc for a -10 dBm input, so a -20 dBm RF input creates a spur that is (2-1) x (-10 dB) dB lower, or 77 dBc.

Typical Downconversion Spurious Suppression (dBc): Square Wave (Sine Wave) LO⁵

-10 dBm RF Input	0xLO	1xLO	2xLO	3xLO	4xLO	5xLO
0xRF	-----	See LO to IF Isolation and LO Harmonic to IF Isolation Plots (Page 3)				
1xRF	24 (27)	Reference	20 (32)	12 (12)	17 (30)	18 (17)
2xRF	67 (63)	65 (62)	67 (62)	68 (57)	67 (56)	70 (56)
3xRF	97 (92)	90 (80)	95 (90)	90 (76)	92 (90)	90 (73)
4xRF	>120	>120	>120	>120	>120	>120
5xRF	>120	>120	>120	>120	>120	>120

A sample downconversion spurious sweep is shown below. An LO which is 100 MHz higher than the RF is used to create a 100 MHz reference IF. A second LO is used to create a 2x2 spurious IF, also at 100 MHz (50 MHz fundamental IF). The difference between these two output levels is the spurious suppression in dBc. The mean value across the full 10 MHz to 12 GHz RF input band is the number shown in the table above.

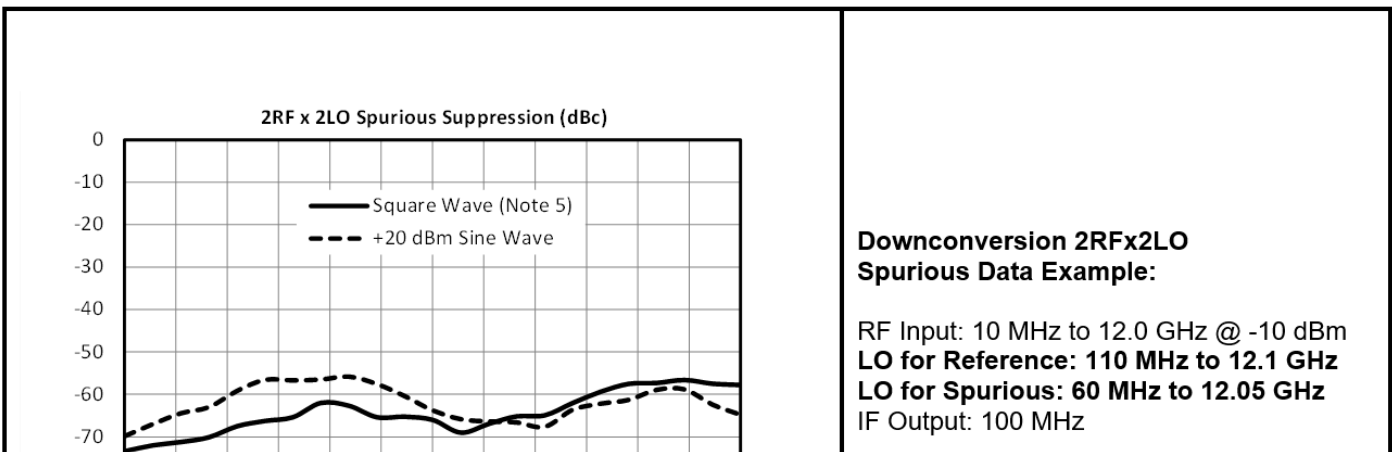

Upconversion Spurious Suppression

Spurious data is taken by mixing a 100 MHz IF with LO frequencies (+mLO+nIF), which creates an RF within the 10 MHz to 12 GHz RF band. The mixer is swept across the full spurious output band and the mean is calculated. The numbers shown in the table below are for a -10 dBm IF input. Spurious suppression is scaled for different IF input power levels by (n-1), where “n” is the IF spur order. For example, the 2IFx1LO spur is typically 64 dBc for a -10 dBm input, so a -20 dBm IF input creates a spur that is (2-1) x (-10 dB) dB lower, or 74 dBc.

Typical Upconversion Spurious Suppression (dBc): Square Wave (Sine Wave) LO⁵

-10 dBm IF Input	0xLO	1xLO	2xLO	3xLO	4xLO	5xLO
0xIF	-----	See LO to RF Isolation and LO Harmonic to RF Isolation Plots (Page 3)				
1xIF	23 (24)	Reference	19 (35)	11 (11)	17 (30)	18 (17)
2xIF	60 (57)	64 (58)	64 (61)	68 (56)	72 (60)	70 (59)
3xIF	97 (96)	88 (76)	95 (90)	95 (75)	97 (86)	97 (75)
4xIF	>120	>120	>120	>120	>120	>120
5xIF	>120	>120	>120	>120	>120	>120

A sample upconversion spurious sweep is shown below. A 100 MHz reference IF input is used to create an RF output that is 100 MHz below the LO input (LO-IF=RF). A second LO (100 MHz higher) is combined with the same 100 MHz IF input (LO+2xIF=RF) to create the same 10 MHz to 12 GHz RF output band. The difference between these two output levels is the spurious suppression in dBc. The mean value across the full RF output band is the number shown in the table above.

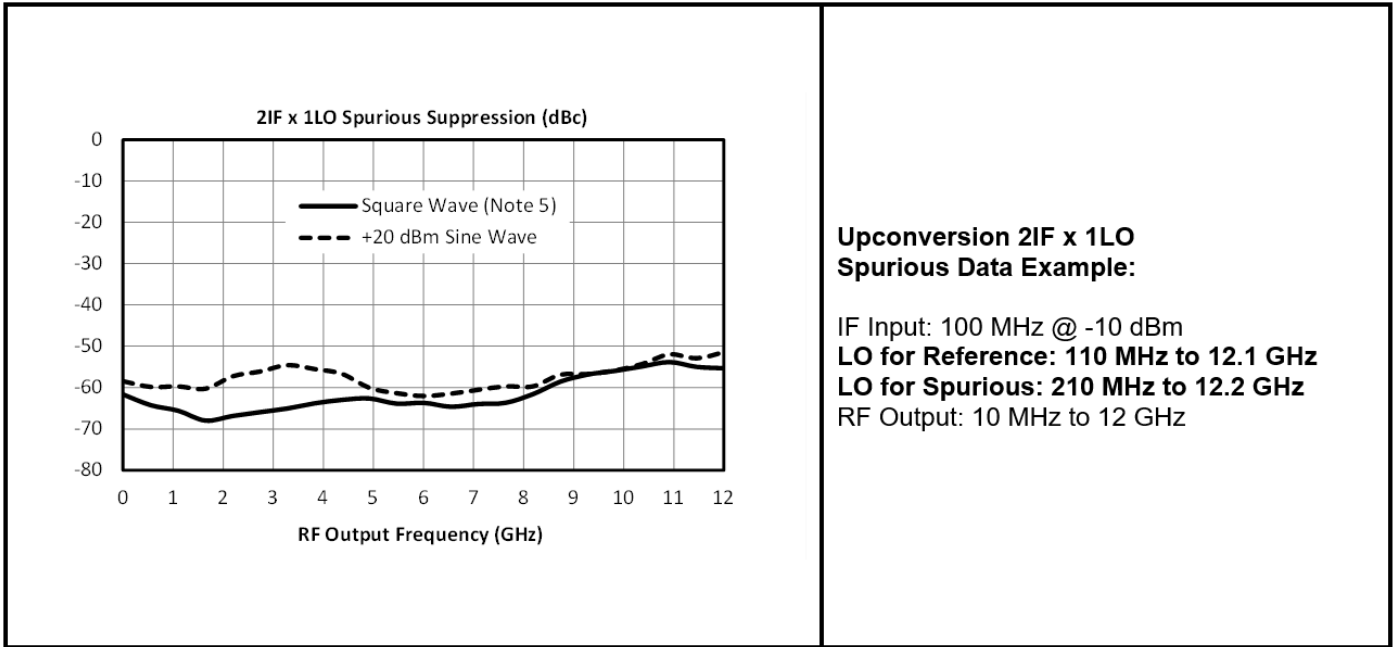

**Upconversion 2IF x 1LO
 Spurious Data Example:**

IF Input: 100 MHz @ -10 dBm
 LO for Reference: 110 MHz to 12.1 GHz
 LO for Spurious: 210 MHz to 12.2 GHz
 RF Output: 10 MHz to 12 GHz

Mechanical Data

Outline Drawing

Download : [Outline 2D Drawing](#) | [Outline 3D Drawing](#) | [Outline 3D STP](#)

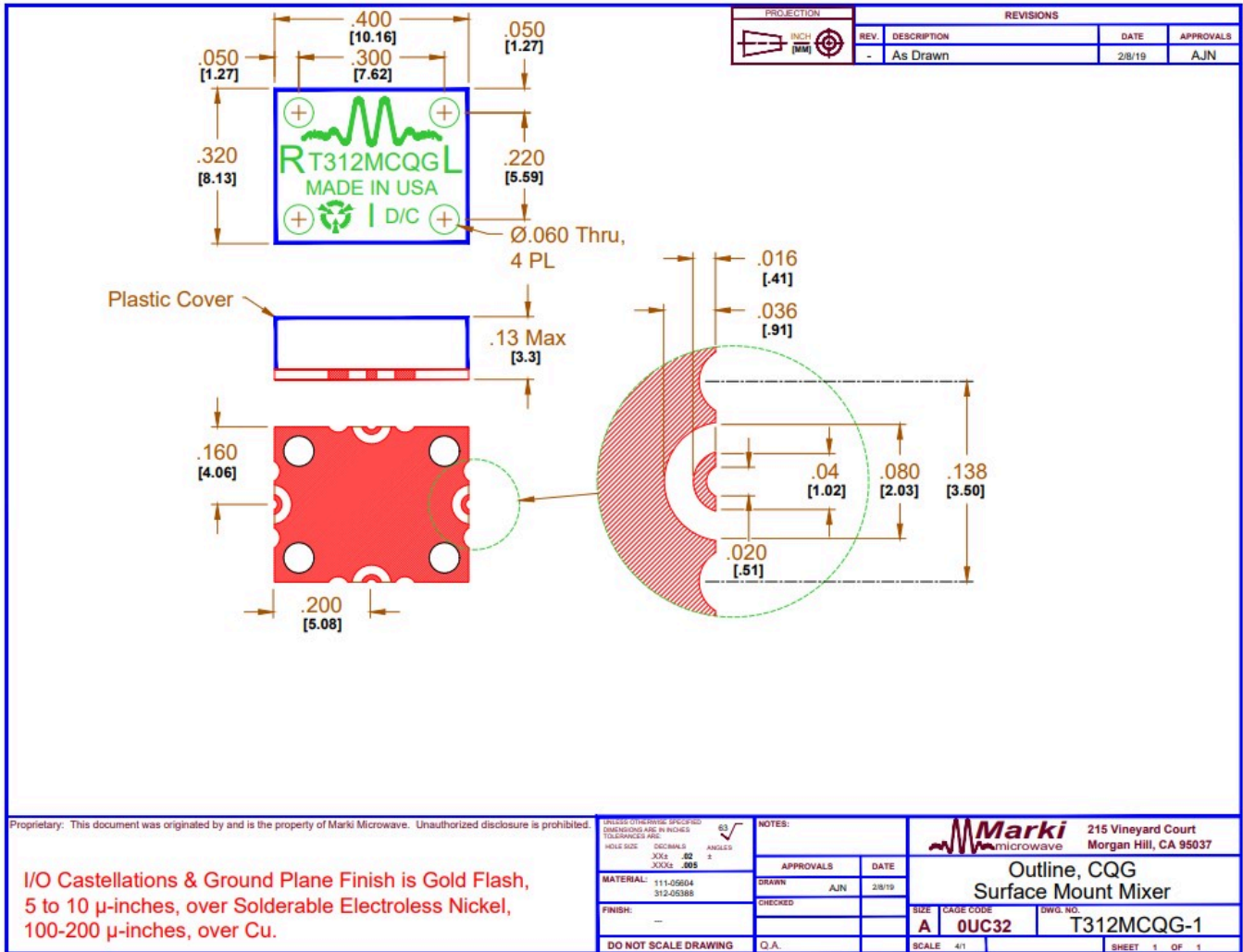

Notes

DATA SHEET NOTES:

1. Mixer Conversion Loss Plot IF frequency is 100 MHz.
2. Mixer Noise Figure typically measures within 0.5 dB of conversion loss for IF frequencies greater than 5 MHz.
3. Conversion Loss typically degrades less than 0.5 dB for LO drives 2 dB below the lowest and 3 dB above highest nominal LO drive levels.
4. Conversion Loss typically degrades less than 0.5 dB at +100°C and improves less than 0.5 dB at -55°C.
5. Square Wave Drive created with an A0015, biased at + 6 Volts, with a +10 dBm input. Sine Wave data is taken with a +20 dBm LO input.
6. Specifications are subject to change without notice. Contact Marki Microwave for the most recent specifications and data sheets.
7. Catalog mixer circuits are continually improved. Configuration control requires custom mixer model numbers and specifications.

DISCLAIMER

MARKI MICROWAVE, INC., ("MARKI") PROVIDES TECHNICAL SPECIFICATIONS AND DATA (INCLUDING DATASHEETS), APPLICATION OR OTHER DESIGN ADVICE, WEB TOOLS, AND OTHER INFORMATION AND RESOURCES "AS IS" AND WITH ALL FAULTS. MARKI DISCLAIMS ALL WARRANTIES, EXPRESS OR IMPLIED, INCLUDING, WITHOUT LIMITATION, ANY IMPLIED WARRANTIES OF MERCHANTABILITY, FITNESS FOR A PARTICULAR PURPOSE, OR NON-INFRINGEMENT.

These resources are intended for developers skilled in the art designing with Marki products. You are solely responsible for (1) selecting the appropriate products for your application, (2) designing, validating, and testing your application, and (3) ensuring your application meets applicable standards and other requirements. Marki makes no guarantee regarding the suitability of its products for any particular purpose, nor does Marki assume any liability whatsoever arising out of your use or application of any Marki product.

Marki grants you permission to use these resources only for development of an application that uses Marki products. Other reproduction or use of these resources is strictly prohibited. No license is granted to any other Marki intellectual property or to any third-party intellectual property. Marki reserves the right to make changes to the product(s) or information contained herein without notice.

MARKI MICROWAVE and T3 MIXER are trademarks or registered trademarks of Marki Microwave, Inc. All other trademarks used are the property of their respective owners.

© 2008, 2018, 2021, Marki Microwave, Inc