

WT45-22L00WG

WR-22 45-Degree Waveguide Left Twist

DEVICE OVERVIEW

General Description

WR-22 45-degree Waveguide Left Twists, operating from 33-50 GHz, provide accurate offsets and directional changes for waveguide transmission lines. They are built with high precision and gold plated for high corrosion resistance. They have very low loss and excellent VSWR. Manufactured to rigid specifications, these transmission line components provide minimum detrimental effects on overall system VSWR.



Features

- Copper waveguide
- Brass UG-383/U flanges
- Gold plated
- Length = 2 in.
- Very low loss

Applications

- 5G
- Radar
- Satellite Communications
- Communication Systems

Functional Block Diagram

N/A

Part Ordering Options

Part Number	Description	Package	Green Status	Product Lifecycle	Export Classification
WT45-22L00WG	WR-22 45-Degree Waveguide Left Twist	WR-22	REACH RoHS	Released	EAR99
WT45-22R00WG	WR-22 45-Degree Waveguide Right Twist	WR-22	REACH RoHS	Released	EAR99

Table Of Contents

- **Device Overview**
 - General Description
 - Features
 - Applications
- **Port Configuration and Functions**
 - Port Functions
- **Revision History**
- **Specifications**
 - Package Information
 - Electrical Specifications
- **Mechanical Data**
 - Outline Drawing

Revision History

Revision Code	Revision Date	Comment
-	2024-05-01	Initial Release

Port Configuration and Functions

Port Functions

Port	Function	Connector Type	Description	Equivalent Circuit for Package
Port 1	RF Input / Output	-	RF input/output port	-
Port 2	RF Input / Output	-	RF input/output port	-

Specifications

Package Information

Parameter	Details	Rating
Dimensions	-	L = 2 in.

Electrical Specifications

Parameter	Test Conditions	Minimum Frequency (GHz)	Maximum Frequency (GHz)	Min	Typ	Max	Unit
Insertion Loss	-	33	50	-	0.13	-	dB
Return Loss	-	33	50	-	37	-	dB

Mechanical Data

Outline Drawing

Download : [Outline 2D Drawing](#)

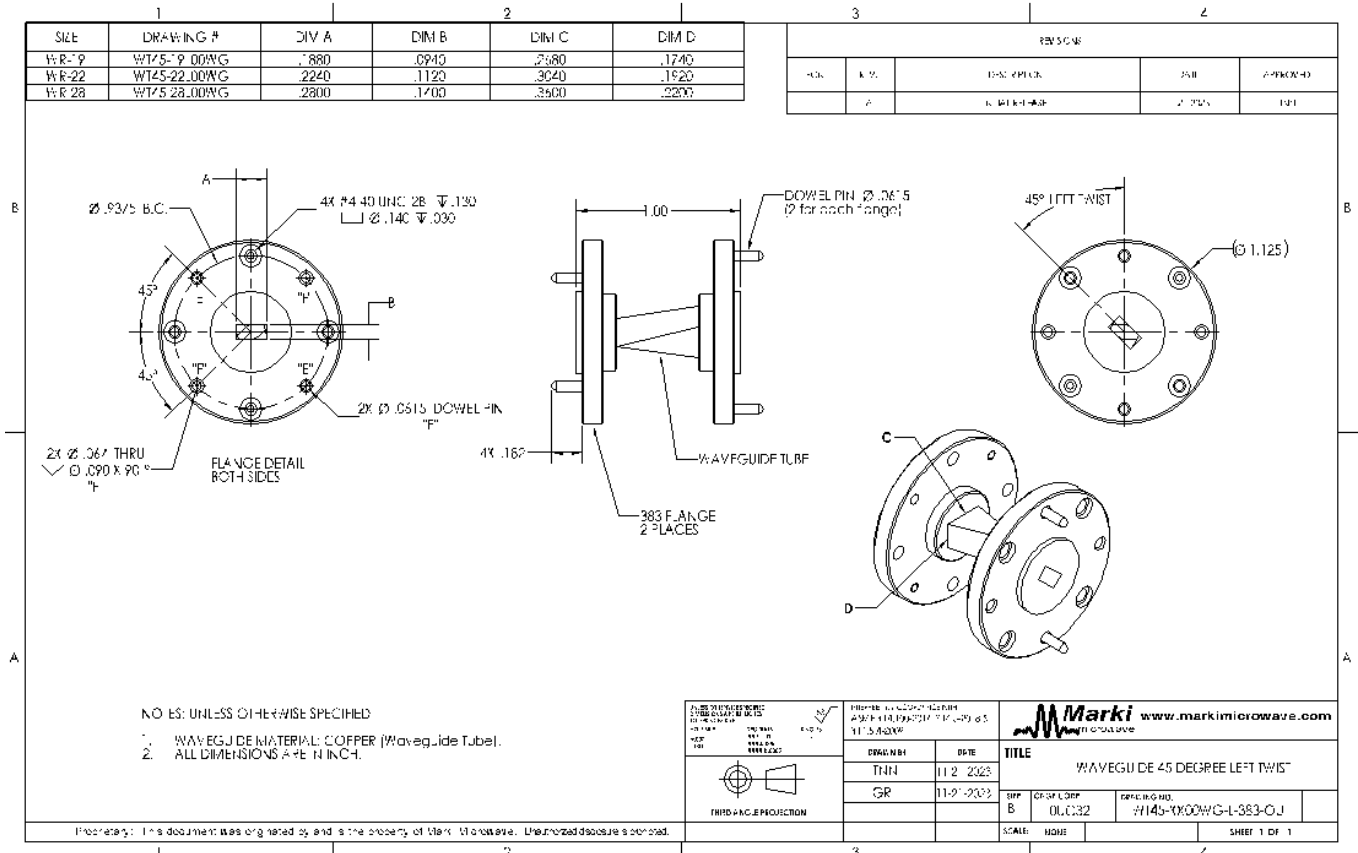

DISCLAIMER

MARKI MICROWAVE, INC., ("MARKI") PROVIDES TECHNICAL SPECIFICATIONS AND DATA (INCLUDING DATASHEETS), APPLICATION OR OTHER DESIGN ADVICE, WEB TOOLS, AND OTHER INFORMATION AND RESOURCES "AS IS" AND WITH ALL FAULTS. MARKI DISCLAIMS ALL WARRANTIES, EXPRESS OR IMPLIED, INCLUDING, WITHOUT LIMITATION, ANY IMPLIED WARRANTIES OF MERCHANTABILITY, FITNESS FOR A PARTICULAR PURPOSE, OR NON-INFRINGEMENT. These resources are intended for developers skilled in the art designing with Marki products. You are solely responsible for (1) selecting the appropriate products for your application, (2) designing, validating, and testing your application, and (3) ensuring your application meets applicable standards and other requirements. Marki makes no guarantee regarding the suitability of its products for any particular purpose, nor does Marki assume any liability whatsoever arising out of your use or application of any Marki product.

Marki grants you permission to use these resources only for development of an application that uses Marki products. Other reproduction or use of these resources is strictly prohibited. No license is granted to any other Marki intellectual property or to any third-party intellectual property. Marki reserves the right to make changes to the product(s) or information contained herein without notice.

MARKI MICROWAVE and T3 MIXER are trademarks or registered trademarks of Marki Microwave, Inc. All other trademarks used are the property of their respective owners.

© 2024, Marki Microwave, Inc