

DCZM29F29

DC-Block

DEVICE OVERVIEW

General Description

These DC blocks feature resonance-free operation and provide superior return loss and insertion loss across very broad bandwidths.

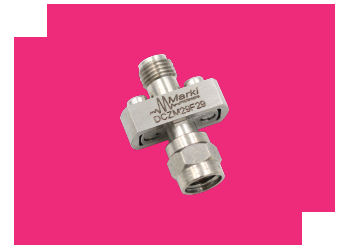

Features

- 4kHz to 40GHz Operation
- 2.92mm Connectors
- Non-Resonant
- Low Insertion Loss
- Convenient easy-grip jacket for effortless loosening

Applications

N/A

Functional Block Diagram

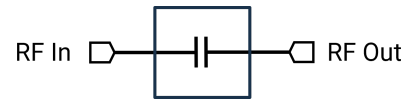

Part Ordering Options

Part Number	Description	Package	Connectors	Green Status	Product Lifecycle	Export Classification
<u>DCZF29F29</u>	DC-Block	K	<u>Standard</u>	<u>Consult Factory</u>	Released	EAR99
DCZM29F29	DC-Block	K	-	Non-RoHS	Released	EAR99
<u>DCZM29M29</u>	DC-Block	K	-	<u>Consult Factory</u>	Released	EAR99

Table Of Contents

- **Device Overview**
 - General Description
 - Features
 - Applications
 - Functional Block Diagram
- **Port Configuration and Functions**
 - Port Functions
- **Revision History**
- **Specifications**
 - Absolute Maximum Ratings
 - Electrical Specifications
 - Typical Performance Plots
 - Oscilloscope measurements of the DC block with a 10 Gb/s PRBS pattern.
- **Mechanical Data**
 - Outline Drawing

Revision History

Revision Code	Revision Date	Comment
-	2014-04-04	Initial Release

Port Configuration and Functions

Port Functions

Port	Function	Connector Type	Description	Equivalent Circuit for Package
In/Out 1	Input/Output	2.92M	RF Input/Output port 1 of the device. Device is passive and reciprocal from port 1 to port 2. Ground is not isolated between ports 1 and 2.	-
In/Out 2	Input/Output	2.92F	RF Input/Output port 2 of the device. Device is passive and reciprocal from port 1 to port 2. Ground is not isolated between ports 1 and 2.	-

Specifications

Absolute Maximum Ratings

Parameter	Maximum Rating	Unit
DC Voltage	16	V
RF Power Handling , Average	1	W

Electrical Specifications

Parameter	Test Conditions	Minimum Frequency (GHz)	Maximum Frequency (GHz)	Min	Typ	Max	Unit
Capacitance	-	0.000004	40	-	1	-	μF
Group Delay	-	0.000004	40	-	75	-	ps
Insertion Loss	-	0.000004	40	-	0.7	1.4	dB
Near DC Insertion Loss	-	0.000002	0.000002	-	3	-	dB
Rise Time ¹	-	0.000004	40	-	6	-	ps
VSWR	-	0.000004	40	-	1.4	-	-

^[1] Specified as 90%/10%. Calculated from $\tau_{balun}^2 = (\tau_{out}^2 - \tau_{in}^2)$ with a 10 Gb/s input pattern.

Typical Performance Plots

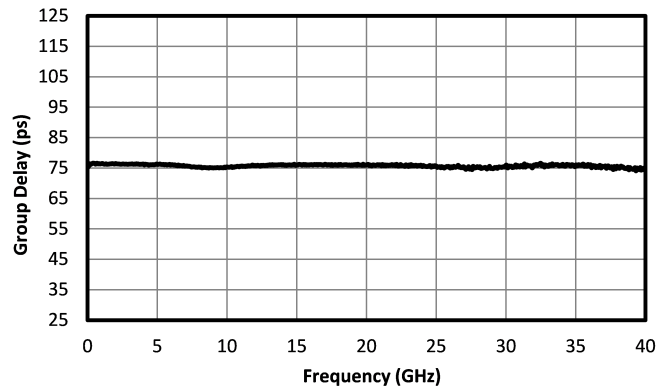
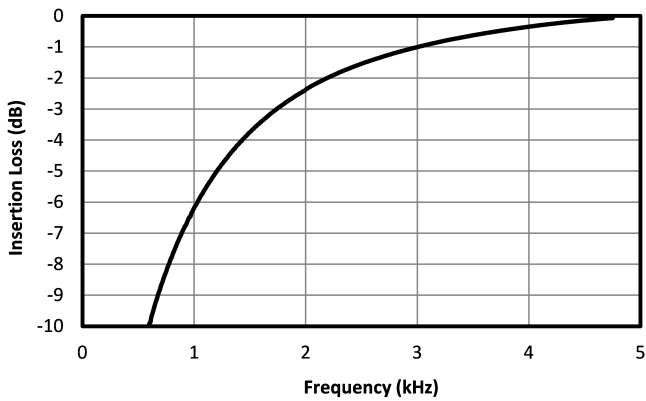
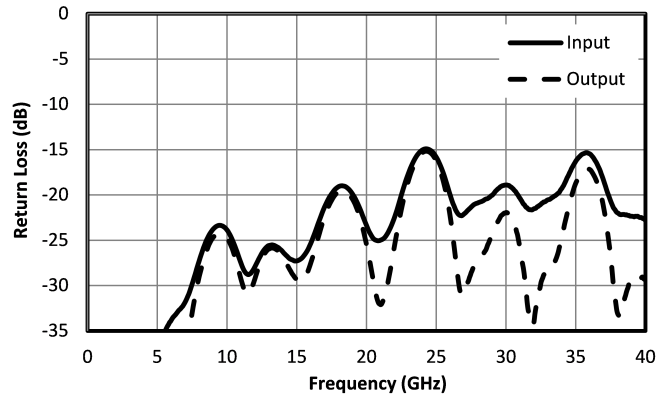
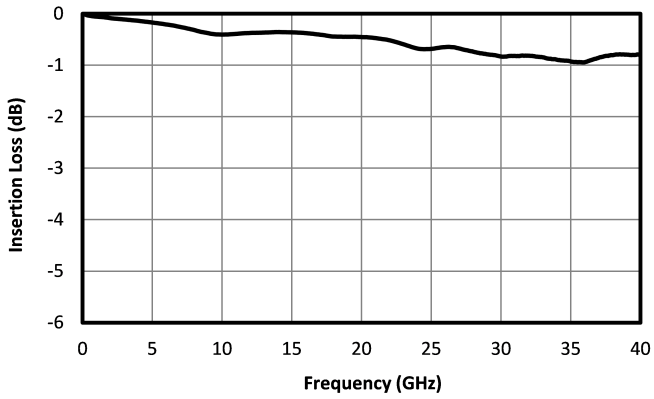

Oscilloscope measurements of the DC block with a 10 Gb/s PRBS pattern.

Eye diagrams are taken with a $2^{31}-1$ P PRBS input demonstrating minimal eye distortion/closure.

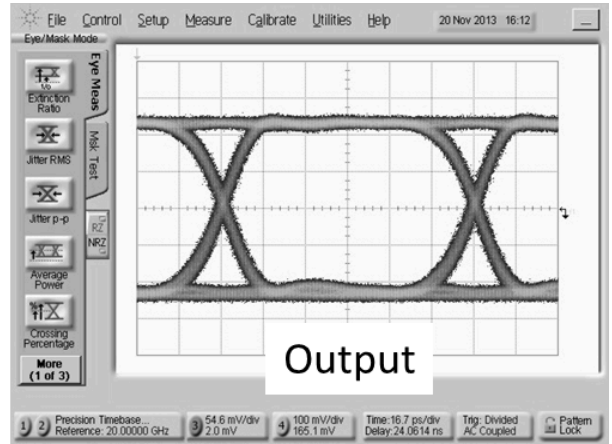
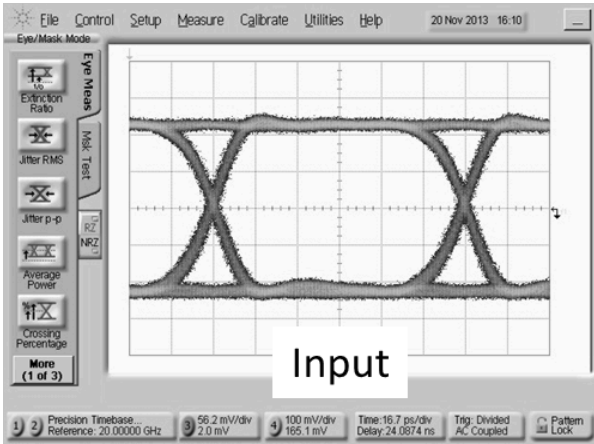

Mechanical Data

Outline Drawing

Download : [Outline 2D Drawing](#)

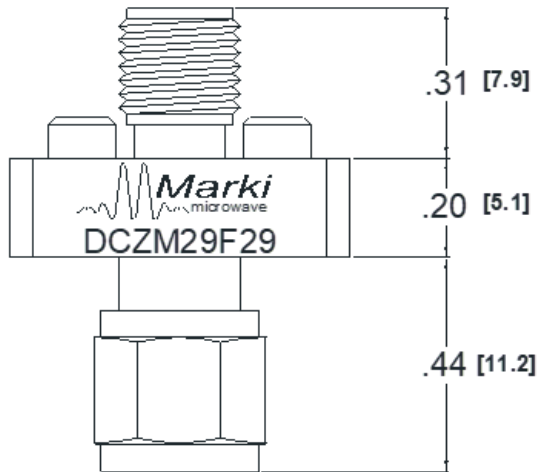

Back Side

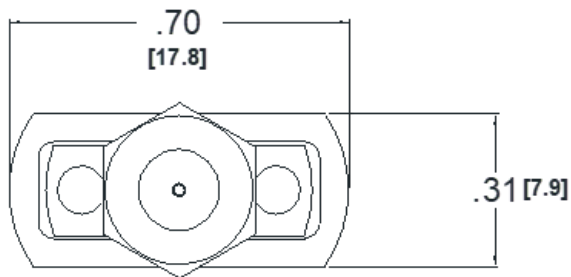

2.92 mm Male Connector

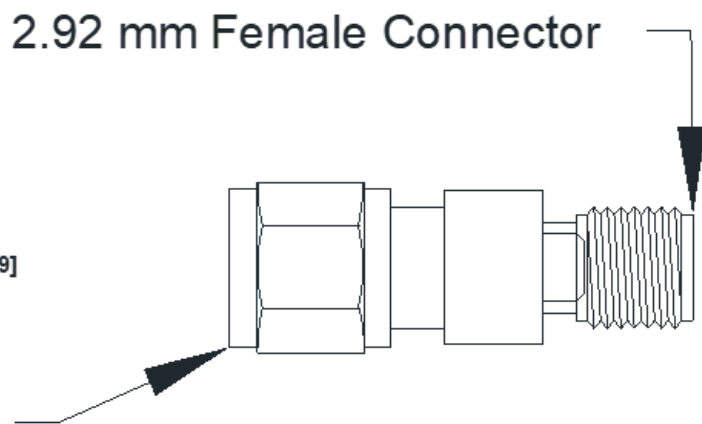

2.92 mm Female Connector

DISCLAIMER

MARKI MICROWAVE, INC., ("MARKI") PROVIDES TECHNICAL SPECIFICATIONS AND DATA (INCLUDING DATASHEETS), APPLICATION OR OTHER DESIGN ADVICE, WEB TOOLS, AND OTHER INFORMATION AND RESOURCES "AS IS" AND WITH ALL FAULTS. MARKI DISCLAIMS ALL WARRANTIES, EXPRESS OR IMPLIED, INCLUDING, WITHOUT LIMITATION, ANY IMPLIED WARRANTIES OF MERCHANTABILITY, FITNESS FOR A PARTICULAR PURPOSE, OR NON-INFRINGEMENT. These resources are intended for developers skilled in the art designing with Marki products. You are solely responsible for (1) selecting the appropriate products for your application, (2) designing, validating, and testing your application, and (3) ensuring your application meets applicable standards and other requirements. Marki makes no guarantee regarding the suitability of its products for any particular purpose, nor does Marki assume any liability whatsoever arising out of your use or application of any Marki product.

Marki grants you permission to use these resources only for development of an application that uses Marki products. Other reproduction or use of these resources is strictly prohibited. No license is granted to any other Marki intellectual property or to any third-party intellectual property. Marki reserves the right to make changes to the product(s) or information contained herein without notice.

MARKI MICROWAVE and T3 MIXER are trademarks or registered trademarks of Marki Microwave, Inc. All other trademarks used are the property of their respective owners.

© 2014, Marki Microwave, Inc