

TW50-15L00WG

Low Power Termination WR-15

DEVICE OVERVIEW

General Description

Low Power Termination WR-15 operates from 50-75 GHz and has great return loss. They use coin silver waveguide with brass flanges and are gold plated.

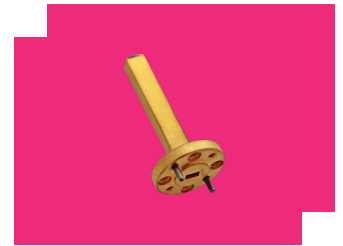

Features

- UG-385/U Flange
- Copper waveguide
- Power Handling 2 W

Applications

- 5G
- Satellite Communications
- Test Systems
- Communication Systems

Functional Block Diagram

N/A

Part Ordering Options

Part Number	Description	Package	Green Status	Product Lifecycle	Export Classification
TW50-15H00WG	High Power Termination WR-15	-	REACH RoHS	Released	EAR99
TW50-15L00WG	Low Power Termination WR-15	WR-15	REACH RoHS	Released	EAR99

Table Of Contents

- **Device Overview**
 - General Description
 - Features
 - Applications
- **Port Configuration and Functions**
 - Port Functions
- **Revision History**
- **Specifications**
 - Absolute Maximum Ratings
 - Electrical Specifications
- **Mechanical Data**
 - Outline Drawing

Revision History

Revision Code	Revision Date	Comment
-	2024-05-01	Initial Release

Port Configuration and Functions

Port Functions

Port	Function	Connector Type	Description	Equivalent Circuit for Package
Port 1	RF Input	-	RF input.	-

Specifications

Absolute Maximum Ratings

Parameter	Maximum Rating	Unit
Power Handling	2	W

Electrical Specifications

Parameter	Test Conditions	Minimum Frequency (GHz)	Maximum Frequency (GHz)	Min	Typ	Max	Unit
Return Loss	-	50	75	-	31	-	dB

Mechanical Data

Outline Drawing

Download : [Outline 2D Drawing](#) | [Outline 3D STP](#)

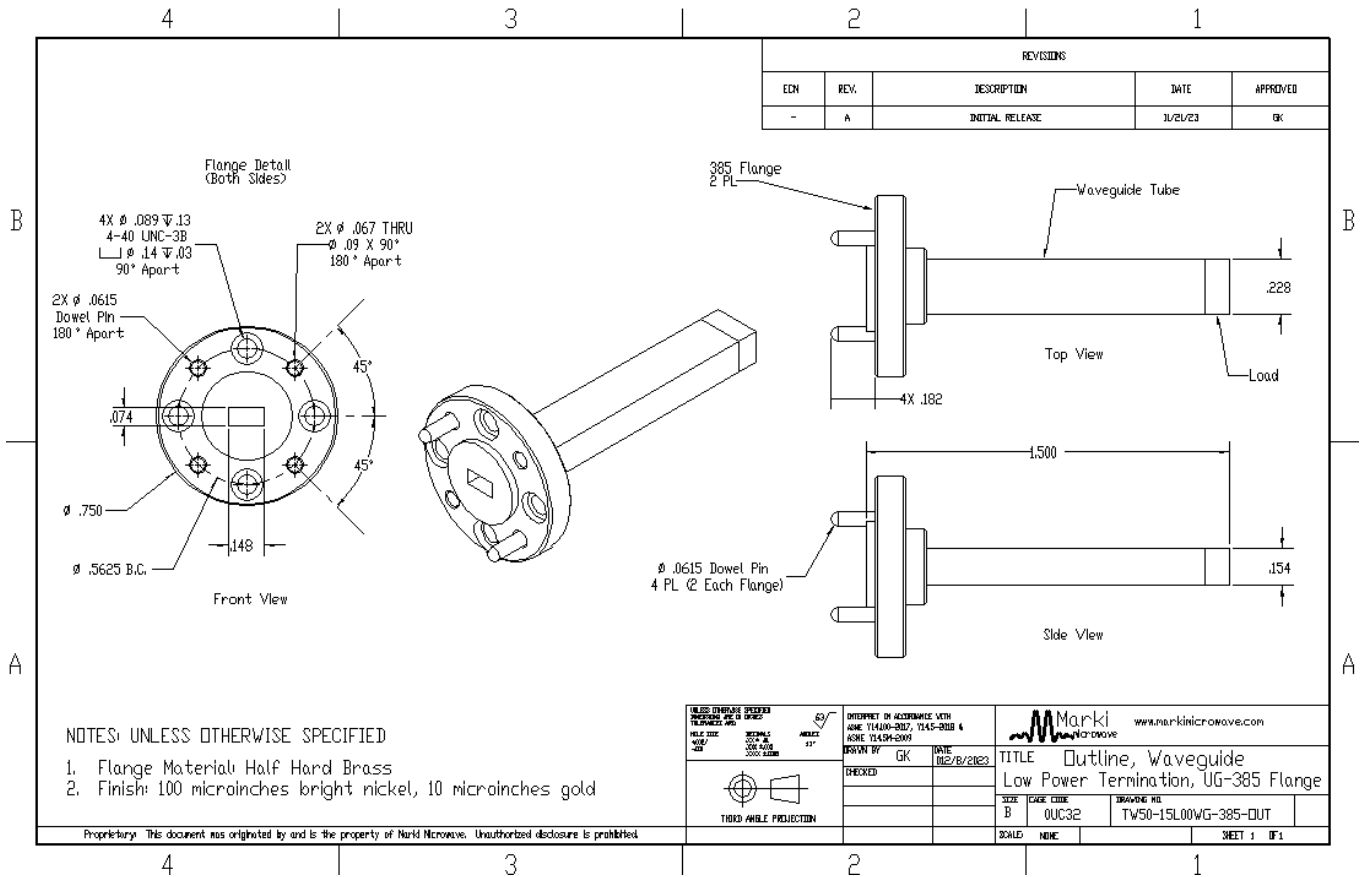

DISCLAIMER

MARKI MICROWAVE, INC., ("MARKI") PROVIDES TECHNICAL SPECIFICATIONS AND DATA (INCLUDING DATASHEETS), APPLICATION OR OTHER DESIGN ADVICE, WEB TOOLS, AND OTHER INFORMATION AND RESOURCES "AS IS" AND WITH ALL FAULTS. MARKI DISCLAIMS ALL WARRANTIES, EXPRESS OR IMPLIED, INCLUDING, WITHOUT LIMITATION, ANY IMPLIED WARRANTIES OF MERCHANTABILITY, FITNESS FOR A PARTICULAR PURPOSE, OR NON-INFRINGEMENT. These resources are intended for developers skilled in the art designing with Marki products. You are solely responsible for (1) selecting the appropriate products for your application, (2) designing, validating, and testing your application, and (3) ensuring your application meets applicable standards and other requirements. Marki makes no guarantee regarding the suitability of its products for any particular purpose, nor does Marki assume any liability whatsoever arising out of your use or application of any Marki product.

Marki grants you permission to use these resources only for development of an application that uses Marki products. Other reproduction or use of these resources is strictly prohibited. No license is granted to any other Marki intellectual property or to any third-party intellectual property. Marki reserves the right to make changes to the product(s) or information contained herein without notice.

MARKI MICROWAVE and T3 MIXER are trademarks or registered trademarks of Marki Microwave, Inc. All other trademarks used are the property of their respective owners.

© 2024, Marki Microwave, Inc