

ATN06-00110

GaAs MMIC DC to 110GHz Attenuator

DEVICE OVERVIEW

General Description

The ATN06-00110 is a family of precision GaAs MMIC fixed attenuators. These attenuators are an ideal solution for attenuating a signal and they can be used in a wide range of applications. They are ideal for test equipment’s protection and signal overload prevention in various RF circuitry. A 50-ohm match is maintained over the entire operating frequency range.

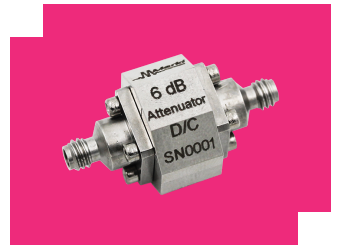

Features

- 6dB attenuation DC to 110GHz
- Return loss: typical 20 dB over the entire band
- Serialized for traceability

Applications

- 5G
- Automotive Radar
- Test Equipment
- Amplitude Matching
- Precision Characterization
- Wireless Backhaul

Functional Block Diagram

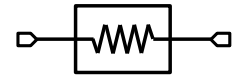

Part Ordering Options

Part Number	Description	Package	Connectors	Green Status	Product Lifecycle	Export Classification
ATN06-00110	GaAs MMIC DC to 110GHz Attenuator	M	<u>Standard</u>	RoHS REACH	Released	EAR99
ATN06-00110-2W	GaAs MMIC DC to 110GHz Attenuator	M	<u>Standard</u>	RoHS REACH	Released	EAR99
ATN06-00110-3W	GaAs MMIC DC to 110GHz Attenuator	M	<u>Standard</u>	RoHS REACH	Released	EAR99

Table Of Contents

- **Device Overview**
 - General Description
 - Features
 - Applications
 - Functional Block Diagram
- **Port Configuration and Functions**
 - Port Functions
- **Revision History**
- **Specifications**
 - Absolute Maximum Ratings
 - Package Information
 - Electrical Specifications
 - Typical Performance Plots
- **Mechanical Data**
 - Outline Drawing

Revision History

Revision Code	Revision Date	Comment
-	2020-10-01	Initial Datasheet Release
A	2020-11-01	Updated Outline Drawings

Port Configuration and Functions

Port Functions

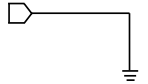
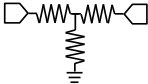
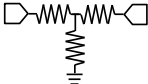
Port	Function	Connector Type	Description	Equivalent Circuit for Package
GND	Ground	-	M package ground provided through metal housing and outer coax conductor.	
Port 1	Input/Output	-	Port 1 and Port 2 are DC connected to each other and ground through a T-network of resistors.	
Port 2	Input/Output	-	Port 1 and Port 2 are DC connected to each other and ground through a T-network of resistors.	

Specifications

Absolute Maximum Ratings

The Absolute Maximum Ratings indicate limits beyond which damage may occur to the device. If these limits are exceeded, the device may be inoperable or have a reduced lifetime.

Parameter	Maximum Rating	Unit
DC Current, any pin	100	mA
Maximum Operating Temperature	100	°C
Maximum Storage Temperature	125	°C
Minimum Operating Temperature	-55	°C
Minimum Storage Temperature	-65	°C
RF Power Handling	2	W

Reliability ratings are individual, a combination of stresses (DC current, RF power, and heat) may cause premature failure).

Package Information

Parameter	Details	Rating
ESD	250 to < 500 Volts	HBM Class 1A
Weight	Package name: M	14.2g
Dimensions	-	14.30 x 27.18 mm

Electrical Specifications

The electrical specifications apply at TA=+25°C in a 50Ω system. Typical data shown is for the attenuator in a M package with a sine wave input applied to port 1.

Parameter	Test Conditions	Minimum Frequency (GHz)	Maximum Frequency (GHz)	Min	Typ	Max	Unit
Attenuation	-	0	110	-	6.5	-	dB
Attenuation Accuracy	-	100	110	-	1.2	-	dB
Attenuation Accuracy	-	0	81	-	0.4	-	dB
Attenuation Accuracy	-	81	100	-	1	-	dB
Impedance	-	0	110	-	50	-	Ω
Return Loss	-	0	81	-	22	-	dB
Return Loss	-	81	100	-	20	-	dB
Return Loss	-	100	110	-	15	-	dB

Typical Performance Plots

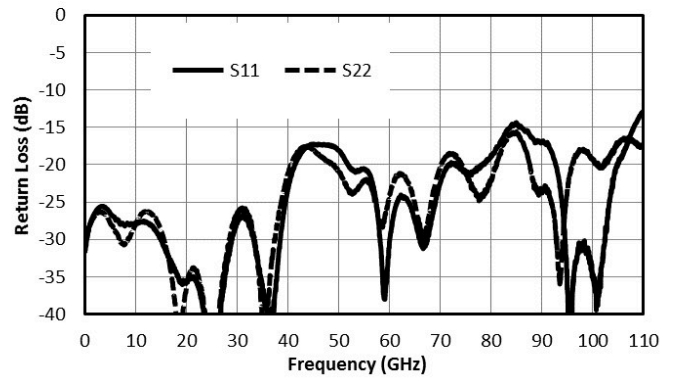
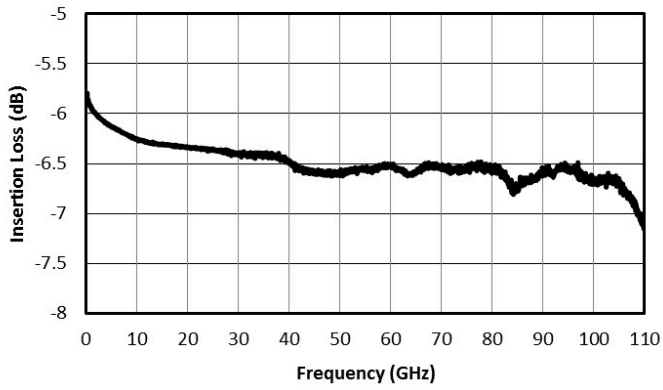

Mechanical Data

Outline Drawing

Download : [Outline 2D Drawing](#) | [Outline 3D Drawing](#) | [Outline 3D STP](#)

All Measurements are typical

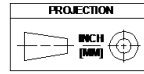

Bottomside View

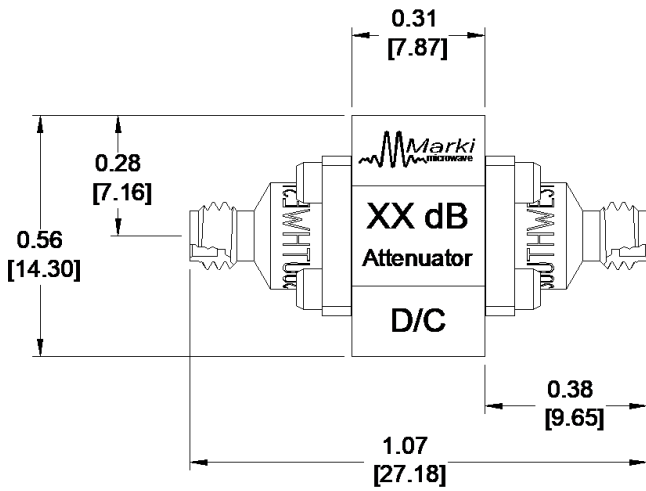

Topside View

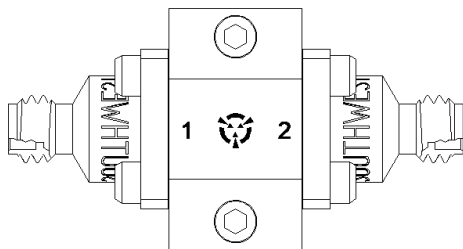

Side View

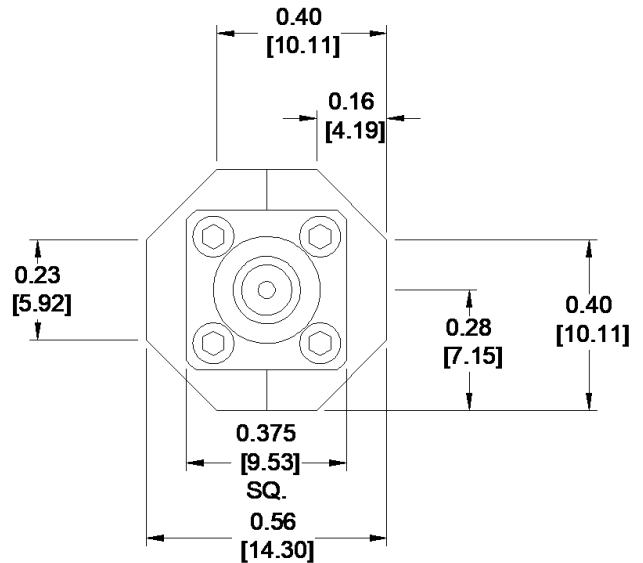

Note: Connectors are not removeable. Do not attempt replacing.

Port	Connector Type
1	1.0 mm Female
2	1.0 mm Female

XX	Part Number
6	ATN06-00110
10	ATN10-00110

1. All measurements are typical.
2. Attach 1.0mm connectors with 45 N-cm (4 in-lb) torque wrench.

DISCLAIMER

MARKI MICROWAVE, INC., ("MARKI") PROVIDES TECHNICAL SPECIFICATIONS AND DATA (INCLUDING DATASHEETS), APPLICATION OR OTHER DESIGN ADVICE, WEB TOOLS, AND OTHER INFORMATION AND RESOURCES "AS IS" AND WITH ALL FAULTS. MARKI DISCLAIMS ALL WARRANTIES, EXPRESS OR IMPLIED, INCLUDING, WITHOUT LIMITATION, ANY IMPLIED WARRANTIES OF MERCHANTABILITY, FITNESS FOR A PARTICULAR PURPOSE, OR NON-INFRINGEMENT. These resources are intended for developers skilled in the art designing with Marki products. You are solely responsible for (1) selecting the appropriate products for your application, (2) designing, validating, and testing your application, and (3) ensuring your application meets applicable standards and other requirements. Marki makes no guarantee regarding the suitability of its products for any particular purpose, nor does Marki assume any liability whatsoever arising out of your use or application of any Marki product.

Marki grants you permission to use these resources only for development of an application that uses Marki products. Other reproduction or use of these resources is strictly prohibited. No license is granted to any other Marki intellectual property or to any third-party intellectual property. Marki reserves the right to make changes to the product(s) or information contained herein without notice.

MARKI MICROWAVE and T3 MIXER are trademarks or registered trademarks of Marki Microwave, Inc. All other trademarks used are the property of their respective owners.

© 2020, Marki Microwave, Inc