

# MFB-2625CH

## Passive MMIC 20.5-32 GHz Bandpass Filter

### DEVICE OVERVIEW

#### General Description

The MFB-2625 is a passive MMIC bandpass filter. It is a low loss integrated filter that passes K to Ka-Band frequencies (20.5-32GHz). Passive GaAs MMIC technology allows production of smaller filter constructions that replace larger form factor circuit board constructions. Tight fabrication tolerances allow for less unit to unit variation than traditional filter technologies. The MFB-2625 is available as a wire bondable chip. Low unit to unit variation allows for accurate simulations using the provided S2P file taken from measured production units.

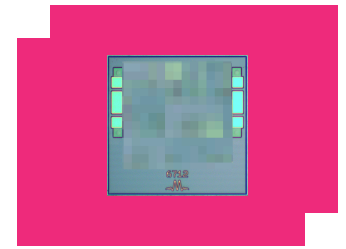

#### Features

- Insertion Loss Typically 1.5dB at Center Frequency
- Excellent Return Loss
- High Stop Band Suppression
- Wide Stop Band

#### Applications

- Designed for K-Band, Ka-Band, 5G, and SATCOM Applications

#### Functional Block Diagram



#### Part Ordering Options

Part Number	Description	Package	Green Status	Product Lifecycle	Export Classification
MFB-2625CH	Passive MMIC 20.5-32 GHz Bandpass Filter	CH	REACH RoHS	Released	EAR99

**Table Of Contents**

- **Device Overview**
  - General Description
  - Features
  - Applications
  - Functional Block Diagram
- **Port Configuration and Functions**
  - Port Diagram
  - Port Functions
- **Revision History**
- **Specifications**
  - Absolute Maximum Ratings
  - Package Information
  - Electrical Specifications
  - Typical performance Plots
- **Die Mounting Recommendations**
  - Mounting and Bounding Recommendations
- **Mechanical Data**
  - Outline Drawing

**Revision History**

Revision Code	Revision Date	Comment
-	2019-02-01	Initial Release

## Port Configuration and Functions

### Port Diagram

A top-down view of the MFB-2625CH package outline drawing is shown below. The MMIC bandpass filters are symmetrical allowing Port 1 or Port 2 to be used as the input.

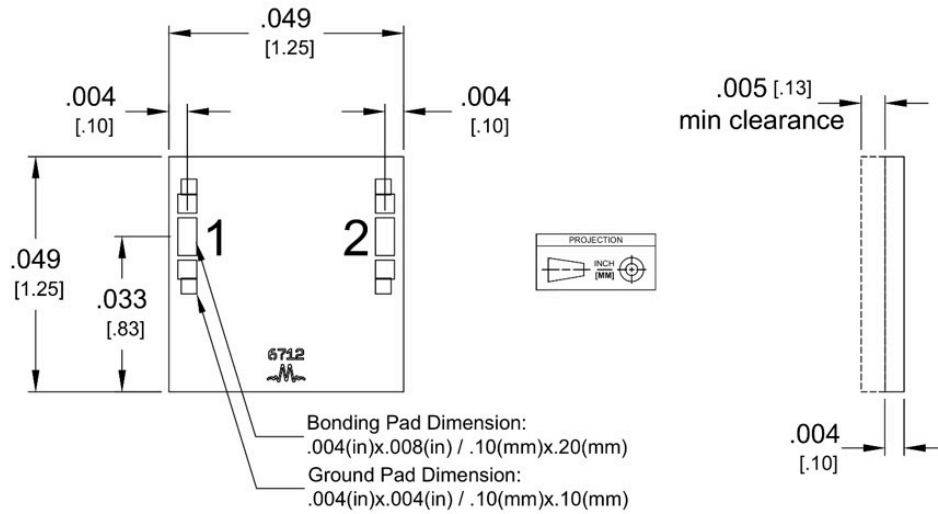

1. CH Substrate material is 0.004 in thick GaAs.
2. I/O trace finish is 5 microns Au. Ground plane finish is 4 microns Au.

## Port Functions

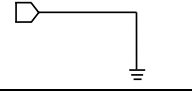
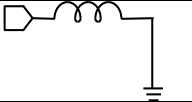
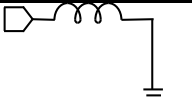
Port	Function	Description	DC Equivalent Circuit
Pad	Ground	CH package ground path is provided through the substrate and ground bond pads.	
Port 1	Input/Output	Port 1 is DC short to ground for the CH package.	
Port 2	Input/Output	Port 2 is DC short to ground for the CH package.	

**Specifications**

**Absolute Maximum Ratings**

The Absolute Maximum Ratings indicate limits beyond which damage may occur to the device. If these limits are exceeded, the device may be inoperable or have a reduced lifetime.

Parameter	Maximum Rating	Unit
Maximum Operating Temperature	100	°C
Maximum Storage Temperature	125	°C
Minimum Operating Temperature	-55	°C
Minimum Storage Temperature	-65	°C
Port 1 DC Current	150	mA
Port 2 DC Current	150	mA

**Package Information**

Parameter	Details	Rating
Dimensions	-	1.25 x 1.25 mm

**Electrical Specifications**

The electrical specifications apply at TA=+25°C in a 50Ω system. Min and Max limits are guaranteed at TA=+25°C. Filter is symmetrical. Reverse measurement is equivalent to forward measurement. All measured data is taken and simulations assume 50 Ω probes on chip.

Parameter	Test Conditions	Minimum Frequency (GHz)	Maximum Frequency (GHz)	Min	Typ	Max	Unit
1 dBc Passband	Configuration A, 25°C	21.78	30.32	-	-	-	GHz
30 dBc Rejection Point	Configuration A, 25°C	16.92	38.86	-	-	-	GHz
3 dBc Passband	Configuration A, 25°C	20.78	31.66	-	-	-	GHz
Center Freq	Configuration A, 25°C	-	-	-	25.70	-	GHz
Group Delay	Configuration A, 25°C	-	-	-	85	-	ps
Impedance	Configuration A, 25°C	-	-	-	50	-	Ω
Insertion Loss @ fc	Configuration A, 25°C	-	-	-	1.4	-	dB
Passband Return Loss	Configuration A, 25°C	-	-	-	27	-	dB
Stopband Suppression	-	6	6	35	45	-	dB
Stopband Suppression	-	16	39	25	30	-	dB

## MFB-2625CH

### Passive MMIC 20.5-32 GHz Bandpass Filter

#### Typical performance Plots

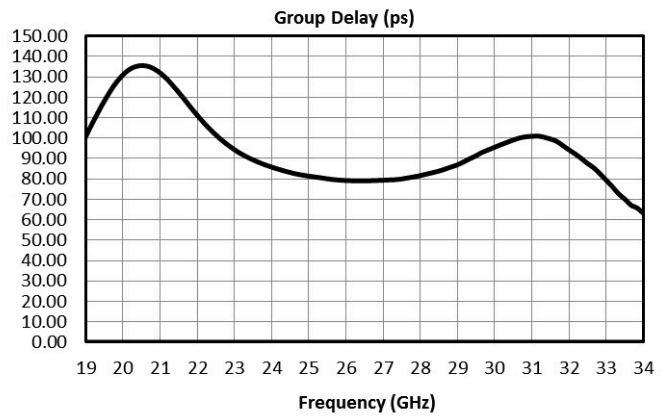
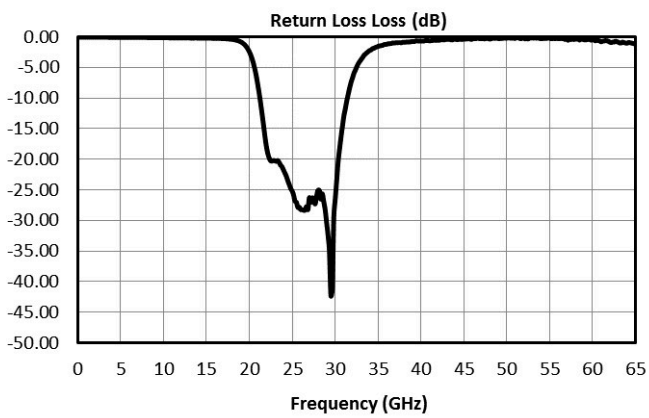
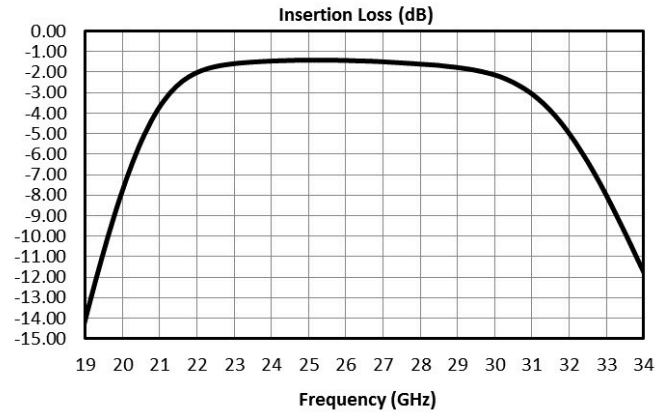
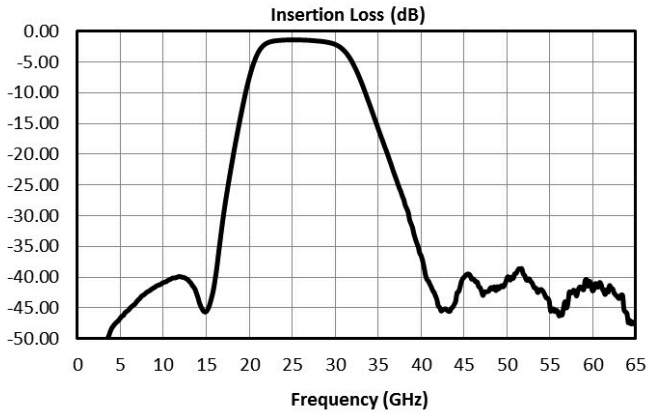

## Die Mounting Recommendations

### Mounting and Bonding Recommendations

Marki MMICs should be attached directly to a ground plane with conductive epoxy. The ground plane electrical impedance should be as low as practically possible. This will prevent resonances and permit the best possible electrical performance. Datasheet performance is only guaranteed in an environment with a low electrical impedance ground.

**Mounting** - To epoxy the chip, apply a minimum amount of conductive epoxy to the mounting surface so that a thin epoxy fillet is observed around the perimeter of the chip. Cure epoxy according to manufacturer instructions.

**Wire Bonding** - Ball or wedge bond with 0.025 mm (1 mil) diameter pure gold wire. Thermosonic wirebonding with a nominal stage temperature of 150 °C and a ball bonding force of 40 to 50 grams or wedge bonding force of 18 to 22 grams is recommended. Use the minimum level of ultrasonic energy to achieve reliable wirebonds. Wirebonds should be started on the chip and terminated on the package or substrate. All bonds should be as short as possible <0.31 mm (12 mils).

**Circuit Considerations** – 50  $\Omega$  transmission lines should be used for all high frequency connections in and out of the chip. Wirebonds should be kept as short as possible, with multiple wirebonds recommended for higher frequency connections to reduce parasitic inductance. In circumstances where the chip more than .001" thinner than the substrate, a heat spreading spacer tab is optional to further reduce bondwire length and parasitic inductance.

**Bonding Diagram**

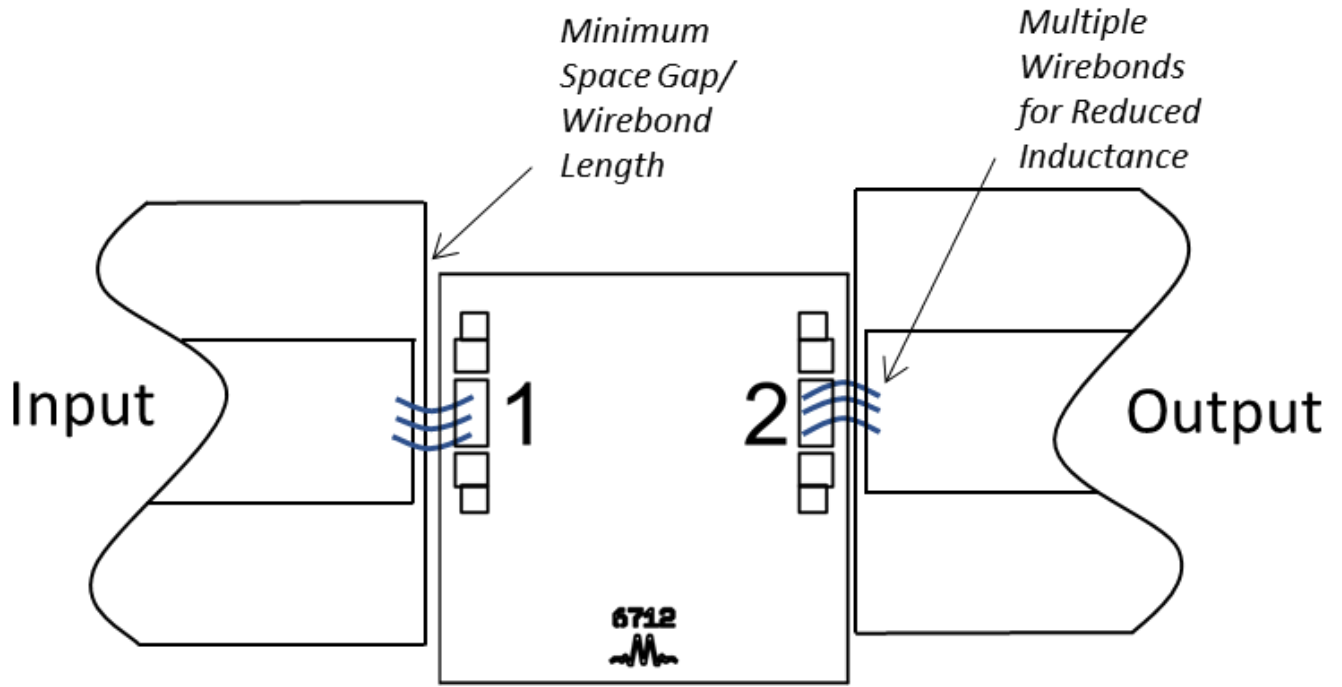

## Handling Precautions

### General Handling

Chips should be handled with care using tweezers or a vacuum collet. Users should take precautions to protect chips from direct human contact that can deposit contaminants, like perspiration and skin oils on any of the chip's surfaces.

### Static Sensitivity

GaAs MMIC devices are sensitive to ESD and should be handled, assembled, tested, and transported only in static protected environments.

**Cleaning and Storage:** Do not attempt to clean the chip with a liquid cleaning system or expose the bare chips to liquid. Once the ESD sensitive bags the chips are stored in are opened, chips should be stored in a dry nitrogen atmosphere.

**Mechanical Data**

**Outline Drawing**

Download : [Outline 2D Drawing](#)

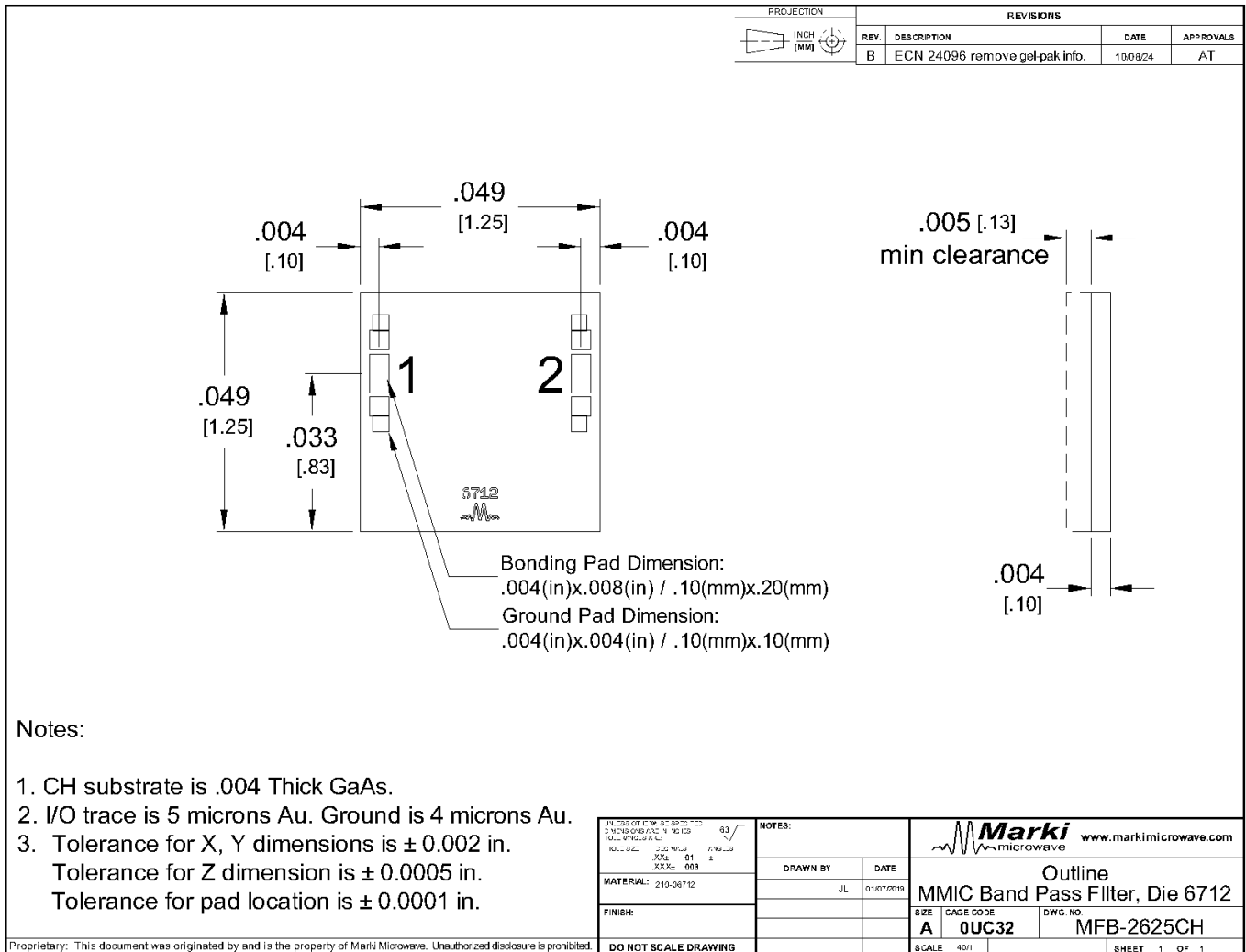

**DISCLAIMER**

MARKI MICROWAVE, LLC., ("MARKI") PROVIDES TECHNICAL SPECIFICATIONS AND DATA (INCLUDING DATASHEETS), APPLICATION OR OTHER DESIGN ADVICE, WEB TOOLS, AND OTHER INFORMATION AND RESOURCES "AS IS" AND WITH ALL FAULTS. MARKI DISCLAIMS ALL WARRANTIES, EXPRESS OR IMPLIED, INCLUDING, WITHOUT LIMITATION, ANY IMPLIED WARRANTIES OF MERCHANTABILITY, FITNESS FOR A PARTICULAR PURPOSE, OR NON-INFRINGEMENT.

These resources are intended for developers skilled in the art designing with Marki products. You are solely responsible for (1) selecting the appropriate products for your application, (2) designing, validating, and testing your application, and (3) ensuring your application meets applicable standards and other requirements. Marki makes no guarantee regarding the suitability of its products for any particular purpose, nor does Marki assume any liability whatsoever arising out of your use or application of any Marki product.

Marki grants you permission to use these resources only for development of an application that uses Marki products. Other reproduction or use of these resources is strictly prohibited. No license is granted to any other Marki intellectual property or to any third-party intellectual property. Marki reserves the right to make changes to the product(s) or information contained herein without notice.

MARKI MICROWAVE and T3 MIXER are trademarks or registered trademarks of Marki Microwave, LLC. All other trademarks used are the property of their respective owners.

© 2019, Marki Microwave, LLC