

AMM-7200ASM

12-46 GHz GaAs Surface Mount LO Driver Amplifier

DEVICE OVERVIEW

General Description

The AMM-7200ASM is a surface-mount amplifier suitable for use as a single tone driver or general-purpose gain block. It can drive an L or H diode mixer from 12 to 46 GHz, or S diode mixer from 14 to 40 GHz. This amplifier also has exceptionally low input and output reflections, and excellent gain flatness in-band. The AMM-7200ASM is packaged in a compact 3mm QFN for surface mount integration onto printed circuit boards

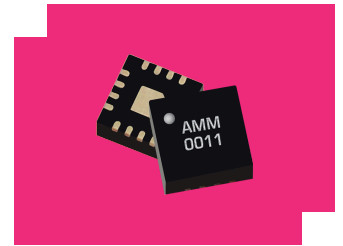

Features

- +18 dB Small Signal Gain
- +22 dBm saturated output power
- Excellent return losses
- Compact 3mm QFN package

Applications

- Mobile test and measurement equipment
- Radar and satellite communications
- 5G transceivers
- LO driver for Marki L-, H-, and S-diode mixers

Functional Block Diagram

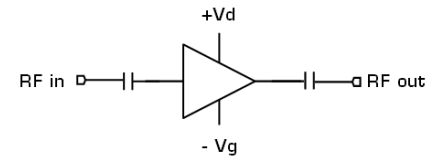

Part Ordering Options

Part Number	Description	Package	Green Status	Product Lifecycle	Export Classification
AMM-7200ASM	12-46 GHz GaAs Surface Mount LO Driver Amplifier	QFN	REACH RoHS	Released	3A001.b.2.d
EVB-AMM-7200ASM	Evaluation Board, 12-46 GHz GaAs Surface Mount LO Driver Amplifier	EVAL	REACH RoHS	Released	EAR99

AMM-7200ASM

12-46 GHz GaAs Surface Mount LO Driver Amplifier

Table Of Contents

■ Device Overview

- General Description
- Features
- Applications
- Functional Block Diagram

■ Port Configuration and Functions

- Port Diagram
- Port Functions

■ Revision History

■ Specifications

- Absolute Maximum Ratings
- Fit and MTTF Table
- Package Information
- Recommended Operating Conditions
- Sequencing Requirements
- Electrical Specifications
- Typical Performance Plots

■ Operation

- Application Information
- Application Circuit
- Application Circuit Description

■ Mechanical Data

- Outline Drawing

■ Footprint Image

■ Evaluation Board

Revision History

Revision Code	Revision Date	Comment
-	2025-03-19	Initial Release
A	2026-02-13	MTTF Table Added.

AMM-7200ASM

12-46 GHz GaAs Surface Mount LO Driver Amplifier

Port Configuration and Functions

Port Diagram

A port diagram of the AMM-7200ASM's QFN package is shown below.

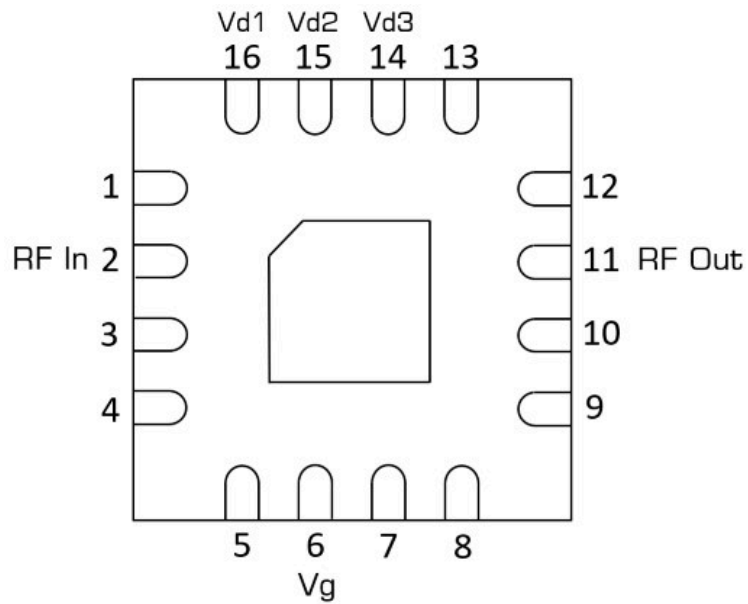

Port Functions

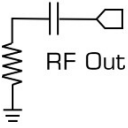
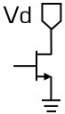
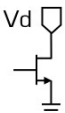
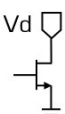
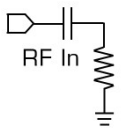
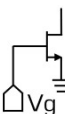
Port	Function	Description	DC Equivalent Circuit
GND	Ground	Ground paddle and non-connected pins must be connected to a DC/RF ground potential with high thermal and electrical conductivity, and low inductance.	GND 
Pin 11	RF Output	Pin 11 is the RF output of the amplifier, and is matched to 50 ohms. It is internally DC blocked.	 RF Out
Pin 14	Positive DC Supply Vd	Pins 14 provides +2.5V to +4V DC voltage to the amplifier's third stage. Negative voltage must be supplied to Pin 6 before turning on the positive supply voltage.	Vd 
Pin 15	Positive DC Supply Vd	Pins 15 provides +2.5V to +4V DC voltage to the amplifier's second stage. Negative voltage must be supplied to Pin 6 before turning on the positive supply voltage.	Vd 
Pin 16	Positive DC Supply Vd	Pins 16 provides +2.5V to +4V DC voltage to the amplifier's first stage. Negative voltage must be supplied to Pin 6 before turning on the positive supply voltage.	Vd 
Pin 2	RF Input	Pin 2 is the RF input of the amplifier, and is matched to 50 ohms. It is internally DC blocked.	 RF In
Pin 6	Negative DC Supply Vg	Pin 6 provides -0.4V to -0.6V of DC voltage. This must be turned on before turning on the positive supply voltage to Pin 1.	 Vg

Specifications

Absolute Maximum Ratings

The Absolute Maximum Ratings indicate limits beyond which damage may occur to the device. If these limits are exceeded, the device may be inoperable or have a reduced lifetime. This amplifier is designed and characterized in a 50Ω system, and operation in a reflective environment can cause performance degradation.

Parameter	Maximum Rating	Unit
Continuous Power Dissipation (PDISS) (at 85 °C case temp.) ¹	1	W
Maximum Operating Temperature	85	°C
Maximum Storage Temperature	150	°C
Max Junction Temperature for MTTF > 1E6 hours	175	°C
Minimum Operating Temperature	-40	°C
Minimum Storage Temperature	-65	°C
Negative Bias Voltage (Pin 6)	-2	V
Positive Drain Supply Current (with RF Input) ²	450	mA
Positive Drain Supply Voltage (Pin 14, 15, 16)	4.5	V
RF Input Power	20	dBm
Thermal Resistance, θJC	94	°C/W

^[1] Derates by 11 mW/ °C above 85 °C case temperature.

^[2] Positive Drain Supply DC current is specified as Id1 + Id2 + Id3

FIT and MTTF Table

T (°C)	λ (TIF)	MTTF (hr)	MTTF (yr)
105	2,441.45	4.10E+05	47
85	310.48	3.22E+06	368
55	8.79	1.14E+08	12,992
25	0.12	8.24E+09	941,063

Package Information

Parameter	Details	Rating
Dimensions	-	3 x 3 mm
Moisture Sensitivity Level	-	MSL 1

Recommended Operating Conditions

The Recommended Operating Conditions indicate the limits, inside which the device should be operated, to guarantee the performance given in Electrical Specifications. Operating outside these limits may not necessarily cause damage to the device, but the performance may degrade outside the limits of the Electrical Specifications. For limits, above which damage may occur, see Absolute Maximum Ratings .

Parameter	Min	Nominal	Max	Unit
Power Supply DC Current ¹	115	180	300	mA
Ambient Temperature	-40	25	85	°C
Input Power for Saturation	6	9	12	dBm
Power Supply DC Voltage	2.5	3	3	V
Gate Bias DC Voltage	-0.6	-0.5	-0.4	V

^[1] Power Supply DC current is specified as Id1 + Id2 + Id3

Sequencing Requirements

Turn-on Procedure:

1. Apply Vg (Pin 6)
2. Apply Vd (Pin 14, 15, 16)

Turn-off Procedure:

1. Turn off Vd (Pin 14, 15, 16)

AMM-7200ASM

12-46 GHz GaAs Surface Mount LO Driver Amplifier

Electrical Specifications

The electrical specifications apply at TA=+25°C in a 50Ω system. QFNs are 100% RF tested.

Parameter	Test Conditions	Minimum Frequency (GHz)	Maximum Frequency (GHz)	Min	Typ	Max	Unit
Small Signal Gain	3V/-0.5V bias, -25 dBm Input Power	12	18	-	17	-	dB
Small Signal Gain	3V/-0.5V bias, -25 dBm Input Power	18	38	-	20	-	dB
Small Signal Gain	3V/-0.5V bias, -25 dBm Input Power	38	46	-	16	-	dB
Input Return Loss	3V/-0.5V bias, -25 dBm Input Power	12	46	-	18	-	dB
Output Return Loss	3V/-0.5V bias, -25 dBm Input Power	12	46	-	14	-	dB
Reverse Isolation	3V/-0.5V bias, -25 dBm Input Power	12	46	-	52	-	dB
Noise Figure	3V/-0.5V Bias	12	46	-	5.1	-	dB
Input Power for Saturation	3V/-0.5V bias	12	46	-	9	-	dBm
Saturated Output Power ¹	3V/-0.5V bias	12	22	-	20	-	dBm
Output IP3	3V/-0.5V bias, -20 dBm Input Power	12	46	-	29	-	dBm
Current Consumption ²	3V/-0.4V	-	-	-	230	-	mA
Current Consumption ³	3V/-0.5V	-	-	-	180	-	mA
Current Consumption ⁴	3V/-0.6V	-	-	-	130	-	mA

^[1] Saturated output power specification defined using the EVAL-AMM-7200SM P5dB compression curve shown in section 3.6, with board losses mathematically extracted.

^[2] Bias conditions for Id tested with no RF input power. See section 3.6 for DC current vs. RF power. Bias conditions presented as Vd/Vg. Drain current is specified as Id1 + Id2 + Id3

^{[3][4]} Bias conditions for Id tested with no RF input power. See section 3.6 for DC current vs. RF power. Bias conditions presented as Vd/Vg. Drain current is specified as Id1 + Id2 + Id3

Typical Performance Plots

Measurement data taken using EVB-AMM-7200P (Open QFN in house build) AFR de-embedded up to surface mount.

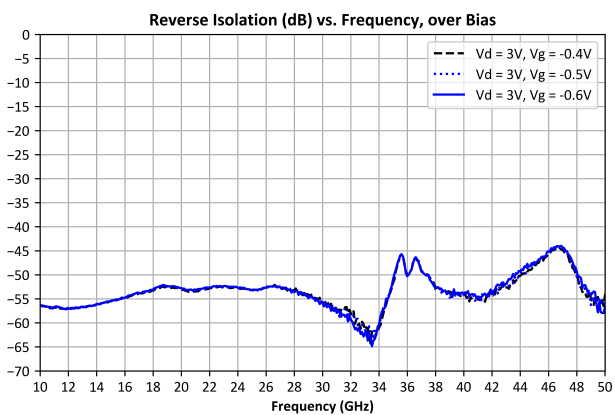
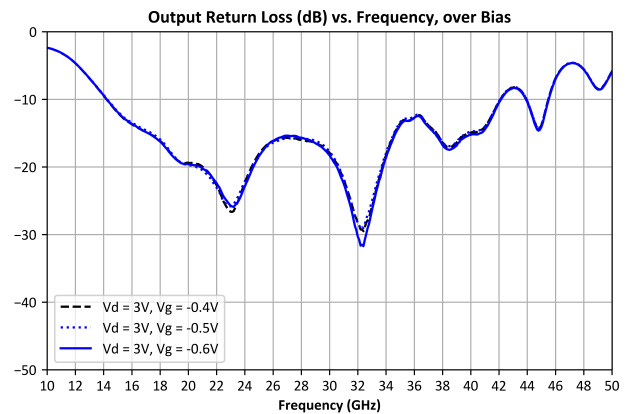
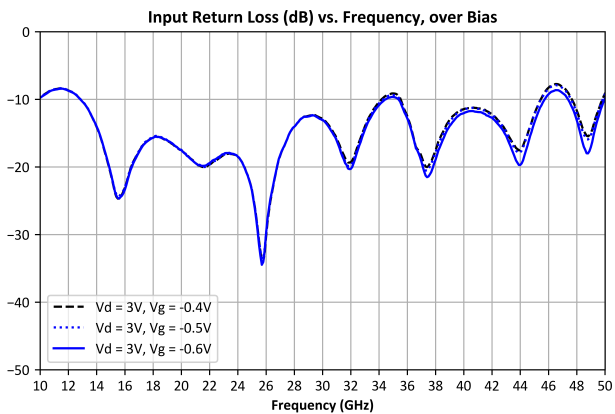
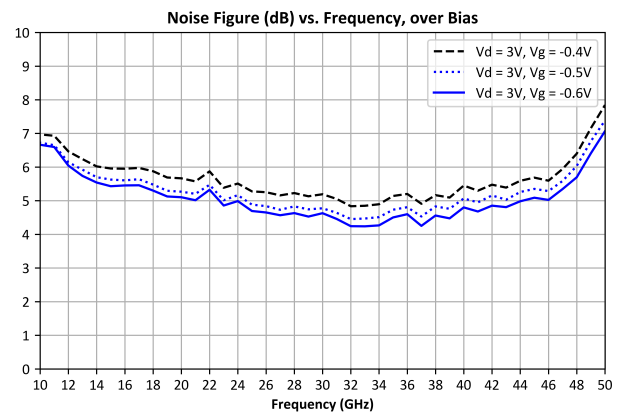
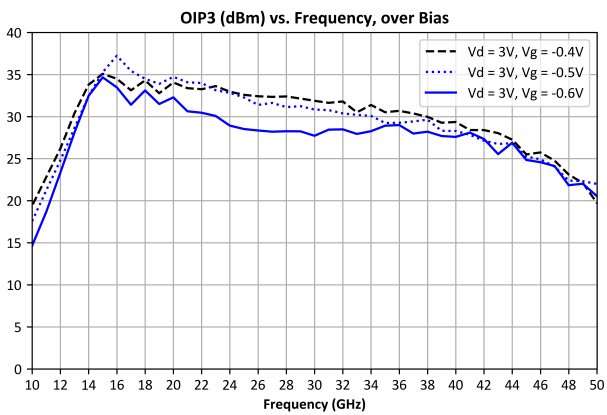
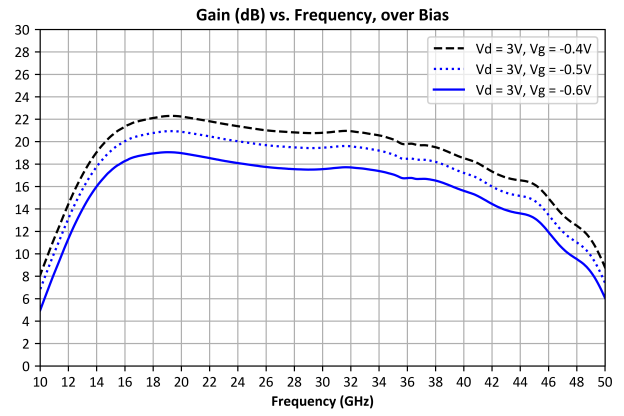
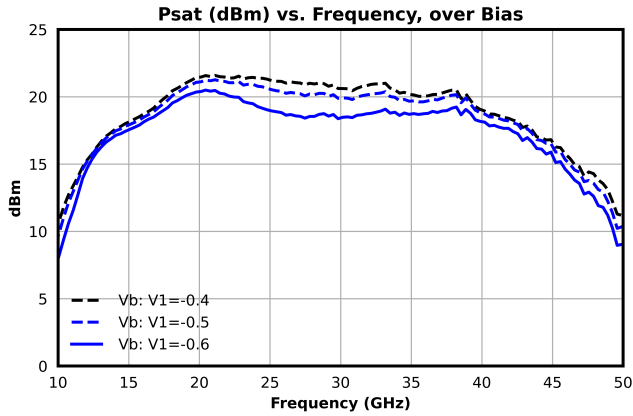

AMM-7200ASM

12-46 GHz GaAs Surface Mount LO Driver Amplifier

Application Information

Below is the recommended application circuit for the AMM-7200ASM. This is the configuration that is used to characterize this device. However, each PCB layout and environment are different which may require minor modifications of the biasing network. Please contact support@markimicrowave.com for more information.

Application Circuit

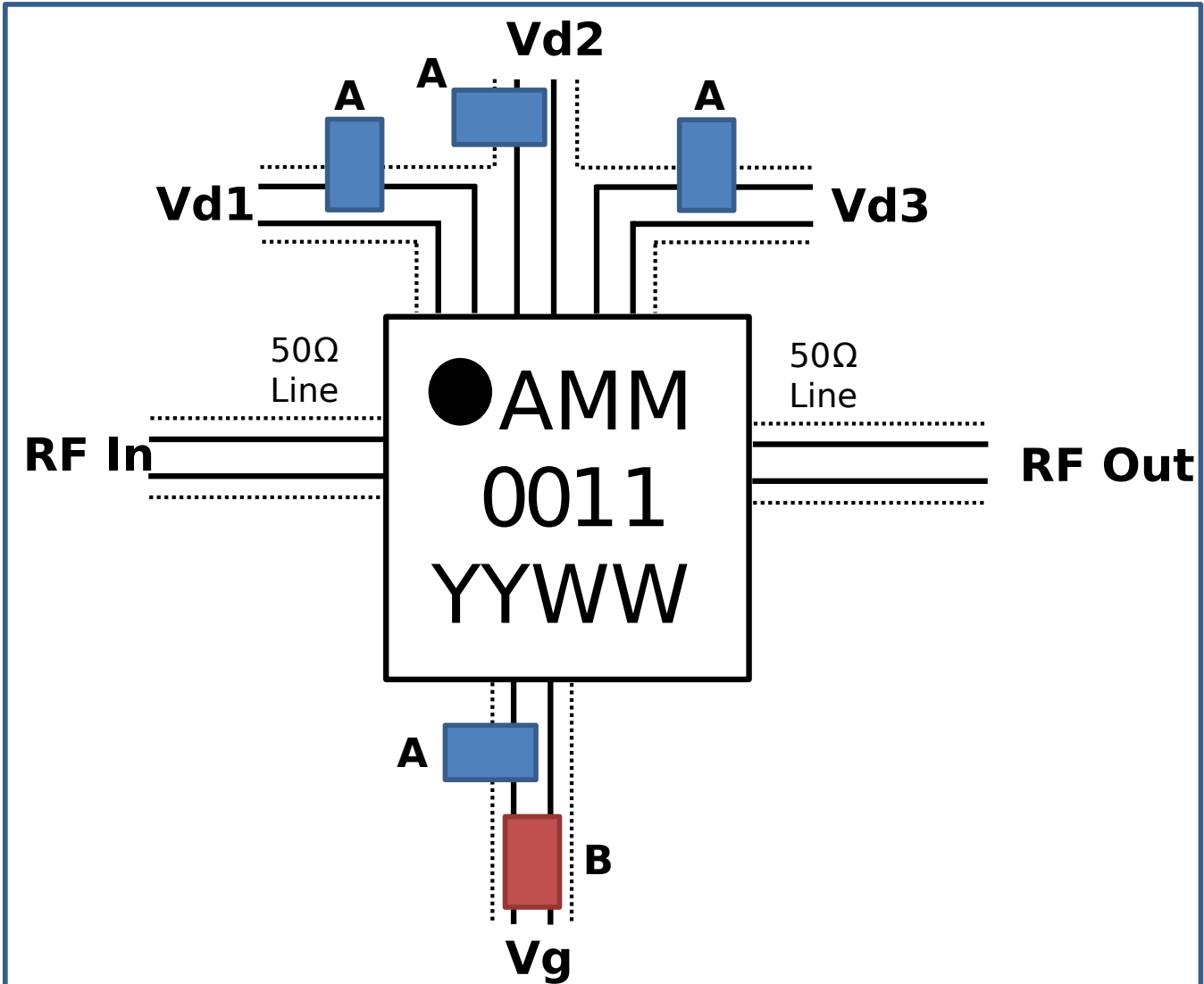

Designator	Description	Sample Part Number
A	0.1μF 16V 0402 Capacitor	AVX 0402YD104KAT2
B	10Ω 0402 Resistor	TE CPF0402B10RE1

AMM-7200ASM

12-46 GHz GaAs Surface Mount LO Driver Amplifier

Application Circuit Description

The three Vd lines are separated to minimize feedback between the transistor's stages. The passive devices should be 0402 or 0201 surface mount. Examples of suitable passive devices would be the AVX 0402YD104KAT2A capacitor and TE CPF0402B10RE1 resistor. In addition to the resistor and capacitor on the gate pin, the layout of the board should be designed to minimize stray coupling between the drain and gate biasing traces on the board. Additionally, the gate biasing pin AMM-7200ASM can draw up to 0.5mA at certain combinations of frequency and input power.

Constant Current and Constant Voltage Operation

As with most amplifiers utilizing HEMT technology, the AMM-7200ASM can be biased with a constant gate and drain voltage, or with a constant drain current by regulating the gate voltage. Using a constant gate and drain voltage for biasing reduces complexity, but has variable current consumption during operation. On the other hand, biasing the gate using a feedback network that samples the drain current minimizes unit-to-unit variation in gain and other parameters.

Under small signal excitation at a fixed temperature, these two approaches are equivalent. However, they will diverge in large signal conditions, where the drain current is affected by the frequency and power of the input signal. In these conditions P1dB, P3dB, and P5dB will be somewhat different, but based on tests with similar parts, they will be within a few dBm of the constant voltage curves.

AMM-7200ASM

12-46 GHz GaAs Surface Mount LO Driver Amplifier

Mechanical Data

Outline Drawing

Download : [Outline 2D Drawing](#) | [Outline 3D Drawing](#) | [Outline 3D STP](#)

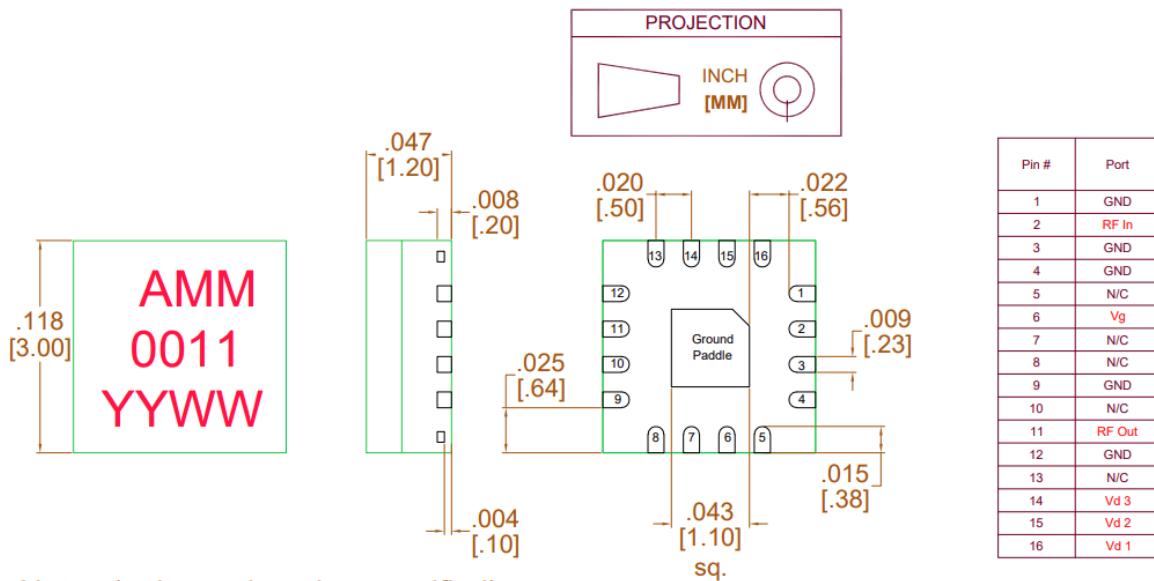

Notes (unless otherwise specified):

- Substrate material is LCP.
- I/O Leads and Die Paddle is (from base to finish):
Ni: 0.5um MIN
Pd: 0.02um MIN
Au: 0.05um MAX
- All unconnected pins should be connected to PCB RF ground.

AMM-7200ASM

12-46 GHz GaAs Surface Mount LO Driver Amplifier

Footprint Image

Download : [Footprint Drawing](#)

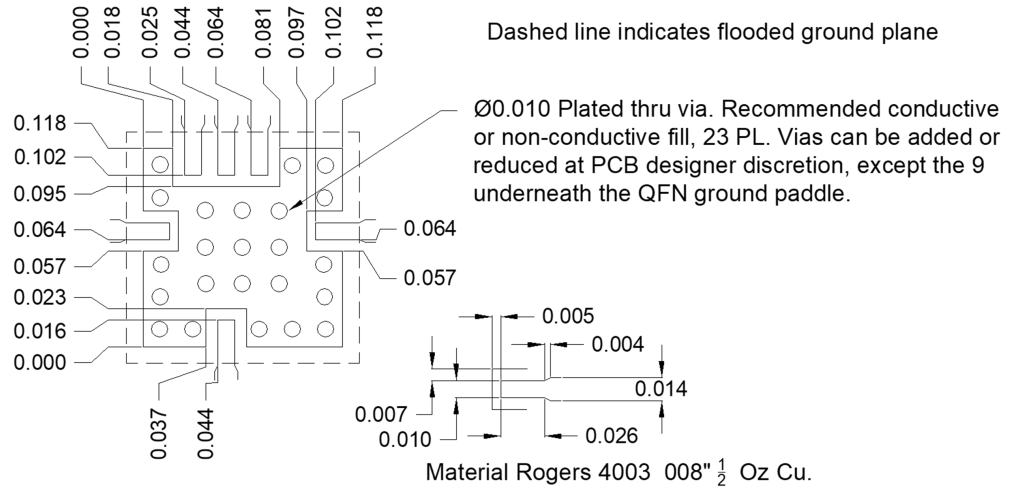
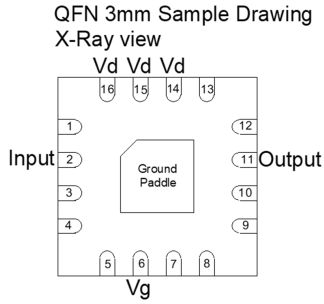

DISCLAIMER

MARKI MICROWAVE, LLC., ("MARKI") PROVIDES TECHNICAL SPECIFICATIONS AND DATA (INCLUDING DATASHEETS), APPLICATION OR OTHER DESIGN ADVICE, WEB TOOLS, AND OTHER INFORMATION AND RESOURCES "AS IS" AND WITH ALL FAULTS. MARKI DISCLAIMS ALL WARRANTIES, EXPRESS OR IMPLIED, INCLUDING, WITHOUT LIMITATION, ANY IMPLIED WARRANTIES OF MERCHANTABILITY, FITNESS FOR A PARTICULAR PURPOSE, OR NON-INFRINGEMENT.

These resources are intended for developers skilled in the art designing with Marki products. You are solely responsible for (1) selecting the appropriate products for your application, (2) designing, validating, and testing your application, and (3) ensuring your application meets applicable standards and other requirements. Marki makes no guarantee regarding the suitability of its products for any particular purpose, nor does Marki assume any liability whatsoever arising out of your use or application of any Marki product.

Marki grants you permission to use these resources only for development of an application that uses Marki products. Other reproduction or use of these resources is strictly prohibited. No license is granted to any other Marki intellectual property or to any third-party intellectual property. Marki reserves the right to make changes to the product(s) or information contained herein without notice.

MARKI MICROWAVE and T3 MIXER are trademarks or registered trademarks of Marki Microwave, LLC. All other trademarks used are the property of their respective owners.

© 2025 - 2026, Marki Microwave, LLC