

TW50-12H00WG

General Description

High Power Termination WR-12 operates from 60-90 GHz and has great return loss. They use coin silver waveguide with brass flanges and are gold plated.

Features

- UG-387/U Flange
- Copper waveguide
- Power Handling 4 W



Electrical Performance

Parameter	Typ	Min	Max	Unit
Frequency Range	-	60	90	GHz
Return Loss	26	60	90	dB

Outline Drawing

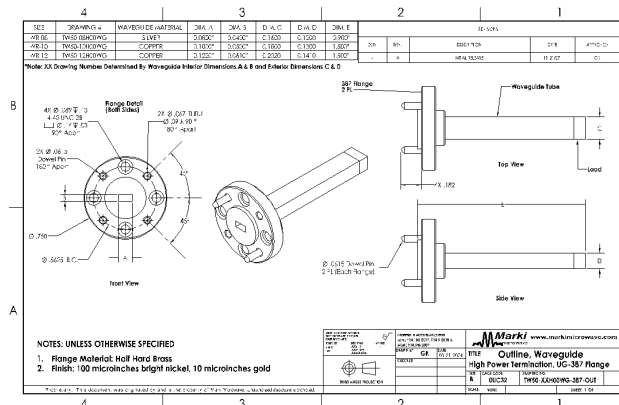

Part Ordering Options

Part Number	Description	Package	Green Status	Product Lifecycle	Export Classification
TW50-12H00WG	High Power Termination WR-12	WR-12	REACH RoHS	Released	EAR99
TW50-12L00WG	Low Power Termination WR-12	WR-12	REACH RoHS	Released	EAR99

Electrical Specifications

Parameter	Test Conditions	Minimum Frequency (GHz)	Maximum Frequency (GHz)	Typ	Min	Max	Unit
Frequency Range	-	60	90	-	-	-	GHz
Return Loss	-	60	90	26	-	-	dB

Specifications

Absolute Maximum Ratings

Parameter	Maximum Rating	Unit
Power Handling	4	W

Port Functions

Port	Function	Connector Type	Description	Equivalent Circuit for Package
Port 1	RF Input	-	RF input.	-

Revision History

Revision Code	Revision Date	Comment
-	2024-05-01	Initial Release

DISCLAIMER

MARKI MICROWAVE, INC., ("MARKI") PROVIDES TECHNICAL SPECIFICATIONS AND DATA (INCLUDING DATASHEETS), APPLICATION OR OTHER DESIGN ADVICE, WEB TOOLS, AND OTHER INFORMATION AND RESOURCES "AS IS" AND WITH ALL FAULTS. MARKI DISCLAIMS ALL WARRANTIES, EXPRESS OR IMPLIED, INCLUDING, WITHOUT LIMITATION, ANY IMPLIED WARRANTIES OF MERCHANTABILITY, FITNESS FOR A PARTICULAR PURPOSE, OR NON-INFRINGEMENT.

These resources are intended for developers skilled in the art designing with Marki products. You are solely responsible for (1) selecting the appropriate products for your application, (2) designing, validating, and testing your application, and (3) ensuring your application meets applicable standards and other requirements. Marki makes no guarantee regarding the suitability of its products for any particular purpose, nor does Marki assume any liability whatsoever arising out of your use or application of any Marki product. Marki grants you permission to use these resources only for development of an application that uses Marki products. Other reproduction or use of these resources is strictly prohibited. No license is granted to any other Marki intellectual property or to any third-party intellectual property. Marki reserves the right to make changes to the product(s) or information contained herein without notice.

MARKI MICROWAVE and T3 MIXER are trademarks or registered trademarks of Marki Microwave, Inc. All other trademarks used are the property of their respective owners.

© 2024, Marki Microwave, Inc