

CE20-0240

Elite 2-40 GHz Directional Coupler

DEVICE OVERVIEW

General Description

The CE20-0240 is a next generation broadband 2GHz to 40GHz, 20dB directional coupler from the Marki Elite Series. Conductive paint is applied to all Elite Series products to reduce EMI/RFI leakage and susceptibility. The CE20-0240 offers the best directivity, return loss, and coupling accuracy available on the market. Available as both a three port directional coupler and a four port bidirectional coupler, the CE20-0240 is an exceptional choice for broadband return loss measurements, power leveling, and signal monitoring applications. Sophisticated neural network design techniques combined with deep circuit knowledge and triplate stripline construction allow the Marki Elite Series of Couplers to provide superior performance to all other directional couplers available.

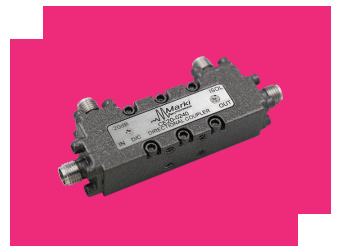

[Download s-parameters here](#)

Features

- Broadband Performance
- Excellent Coupling Flatness
- High Directivity
- Low VSWR
- Conductive paint minimizes RF leakage

Applications

N/A

Functional Block Diagram

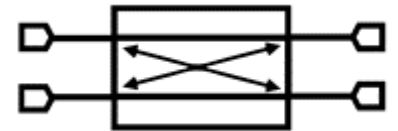

Part Ordering Options

Part Number	Description	Connectors	Green Status	Product Lifecycle	Export Classification
CE20-0240T	Elite 2-40 GHz Directional Coupler	Standard	REACH RoHS	Released	EAR99
CE20-0240	Elite 2-40 GHz Directional Coupler	Standard	REACH RoHS	Released	EAR99

Table Of Contents

- **Device Overview**
 - General Description
 - Features
 - Applications
 - Functional Block Diagram
- **Port Configuration and Functions**
 - Port Diagram
 - Port Functions
- **Revision History**
- **Specifications**
 - Absolute Maximum Ratings
 - Package Information
 - Electrical Specifications
 - Typical Performance Plots
 - Performance Over Temperature
 - Terminated Return Loss and Directivity
- **Mechanical Data**
 - Outline Drawing

Revision History

Revision Code	Revision Date	Comment
-	2021-12-01	Datasheet Initial Release
A	2022-04-01	Terminated Option Added, Operating and Storage Temperatures Updated

Port Configuration and Functions

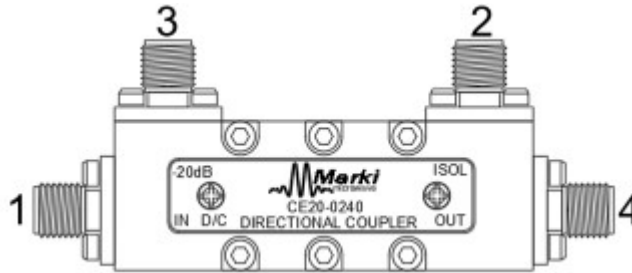

Port Diagram

A side view of the CE20-0240 package outline drawing is shown below. The CE20-0240 has input and output ports given in Port Functions. The CE20-0240 can be used in either the forward or reverse direction corresponding to configuration A and B respectively. For configuration A, input signal into port 1, use port 3 for coupled port, port 2 for isolated port, and port 4 for output port. For configuration B, input signal into port 4, use port 2 for coupled port, port 3 for isolated port, and port 1 for output port.



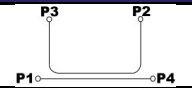
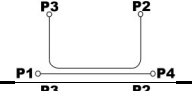
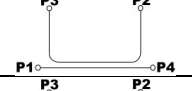

Port Functions

Configuration A

Port	Function	Connector Type	Description	DC Equivalent Circuit
Port 1	Input	2.92F	The input port is DC short to the output port and open to the isolated and coupled ports.	
Port 2	Isolated	2.92F	The isolated port is DC short to the coupled port and open to the input and output ports.	
Port 3	Coupled	2.92F	The coupled port is DC short to the isolated port and open to the input and output ports.	
Port 4	Output	2.92F	The output port is DC short to the input port and open to the isolated and coupled ports.	

Configuration B

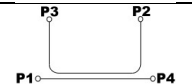
Port	Function	Connector Type	Description	DC Equivalent Circuit
Port 1	Output	2.92F	The input port is DC short to the output port and open to the isolated and coupled ports.	
Port 2	Coupled	2.92F	The isolated port is DC short to the coupled port and open to the input and output ports.	
Port 3	Isolated	2.92F	The coupled port is DC short to the isolated port and open to the input and output ports.	
Port 4	Input	2.92F	The output port is DC short to the input port and open to the isolated and coupled ports.	

Specifications

Absolute Maximum Ratings

The Absolute Maximum Ratings indicate limits beyond which damage may occur to the device. If these limits are exceeded, the device may be inoperable or have a reduced lifetime.

Parameter	Maximum Rating	Unit
RF Power Handling	20	W
Minimum Operating Temperature	-55	°C
Maximum Operating Temperature	100	°C
Minimum Storage Temperature	-65	°C
Maximum Storage Temperature	125	°C

Package Information

Parameter	Details	Rating
Dimensions	-	49.57 × 17.53 mm

Electrical Specifications

The electrical specifications apply at TA=+25°C in a 50Ω system

Parameter	Port Configuration	Test Conditions	Minimum Frequency (GHz)	Maximum Frequency (GHz)	Min	Typ	Max	Unit
Amplitude Flatness ¹	-	-	2	40	-	0.1	0.25	dB
Coupling Loss ²	-	-	2	40	0.039	0.044	0.049	dB
Directivity	-	-	2	40	19	32	-	dB
Direct Line Insertion Loss	-	DC-40	-	-	-	0.5	1.1	dB
Excess Insertion Loss (dB) ³	-	DC-40	-	-	-	0.44	1	dB
IL Corrected Directivity ⁴	-	-	2	40	20	33	-	dB
Impedance	-	-	-	-	-	50	-	Ω
Maximum Coupling Deviation	-	-	2	40	-	0.5	1	dB
Mean Coupling	-	-	2	40	19.5	20	20.5	dB
Return Loss	-	DC-40	-	-	20	32	-	dB
VSWR	-	DC-40	-	-	-	1.05	1.22	

[1] Amplitude Flatness = Median value of ABS(Measured Coupling Power – Average Coupling Factor).

[2] Coupling loss based on average coupling factor.

[3] Excess Insertion Loss = (Input Port to Output Port Insertion Loss) – Coupling Loss.

[4] IL Corrected Directivity = Directivity + Insertion Loss.

Typical Performance Plots

Insertion Loss, Return Loss, Coupled Port Power, and Directivity

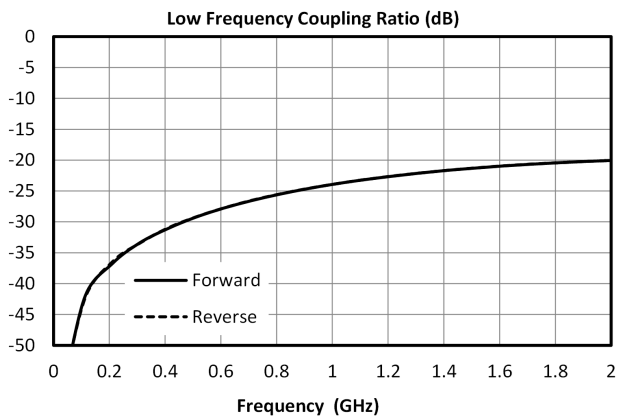
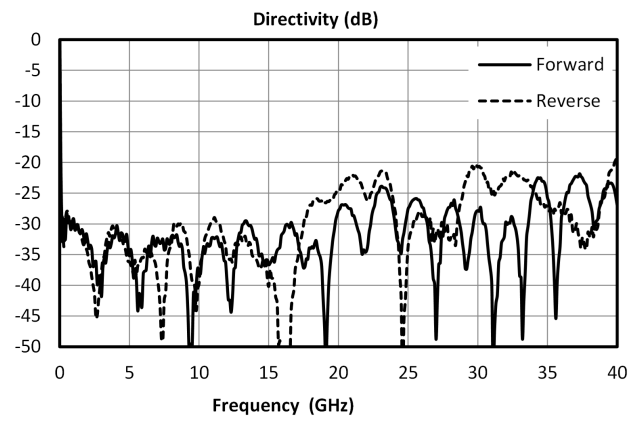
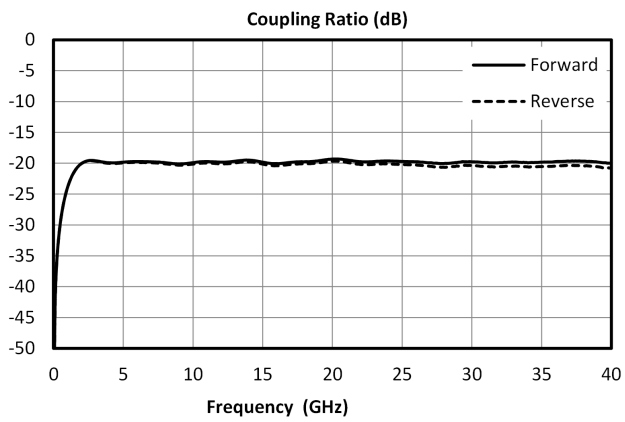
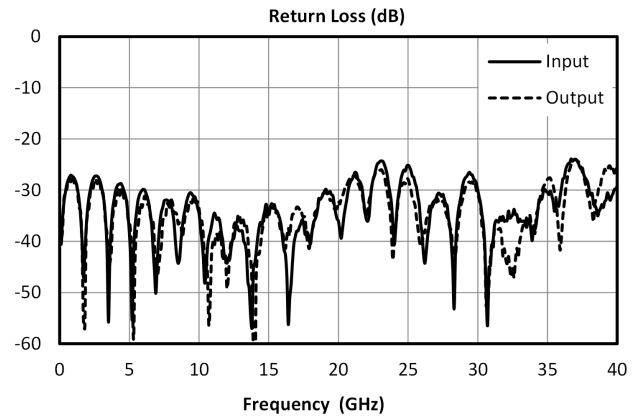
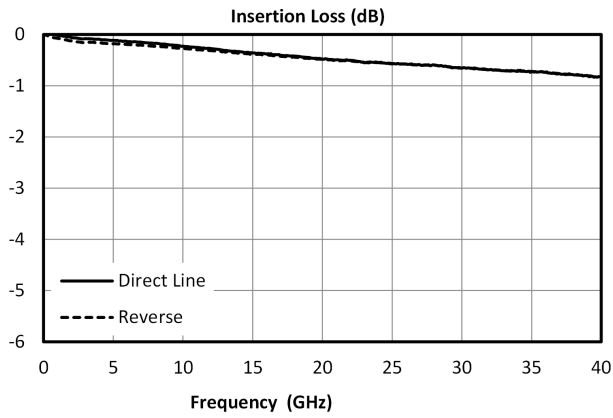

Performance Over Temperature

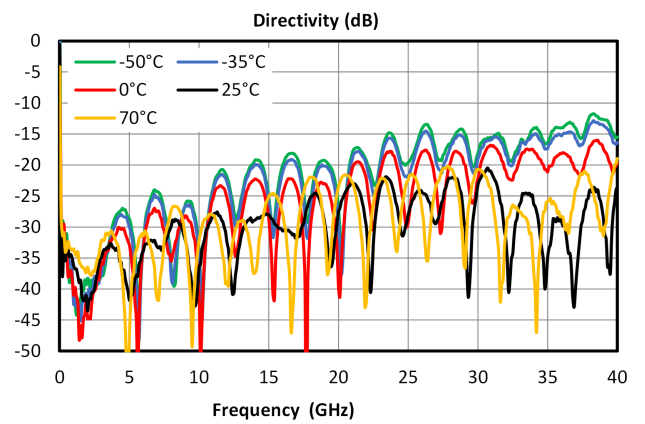
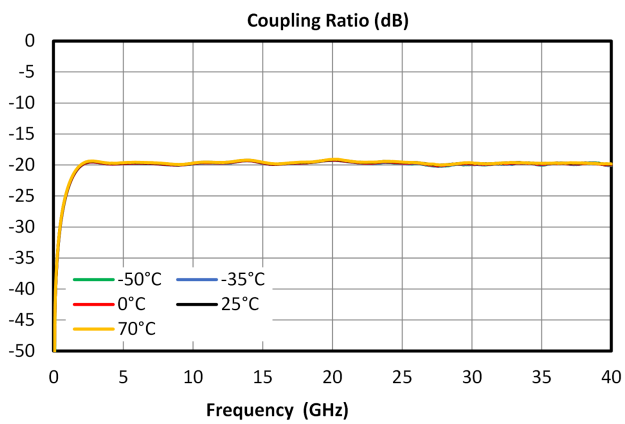
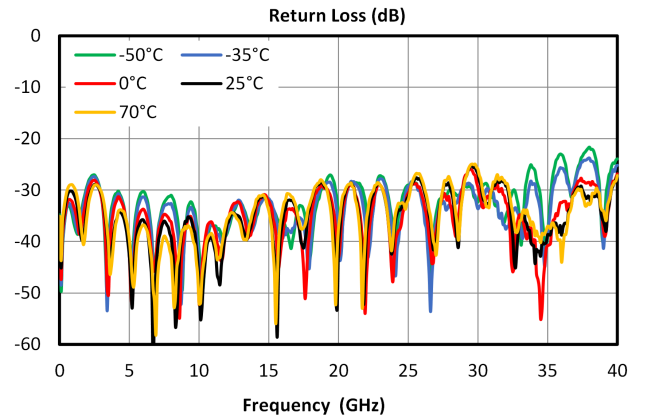
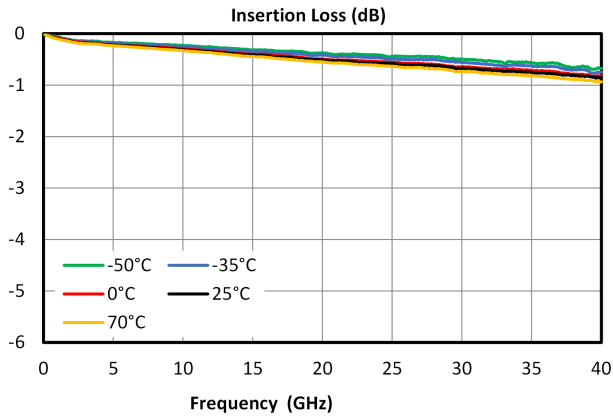

Terminated Return Loss and Directivity

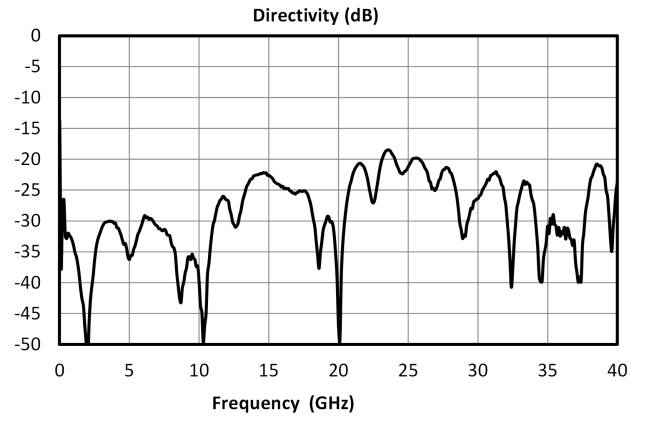
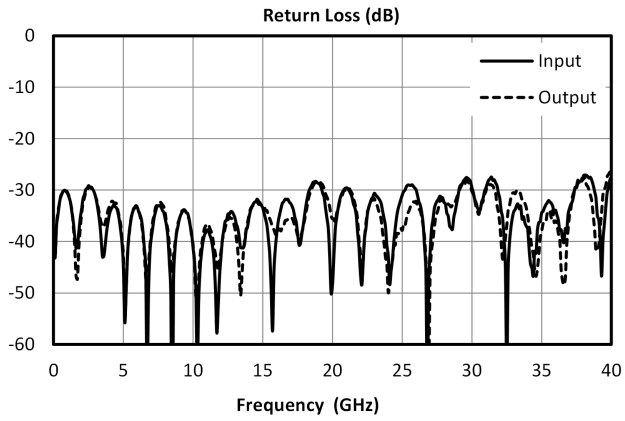

Mechanical Data

Outline Drawing

Download : [Outline 2D Drawing](#) | [Outline 3D Drawing](#) | [Outline 3D STP](#)

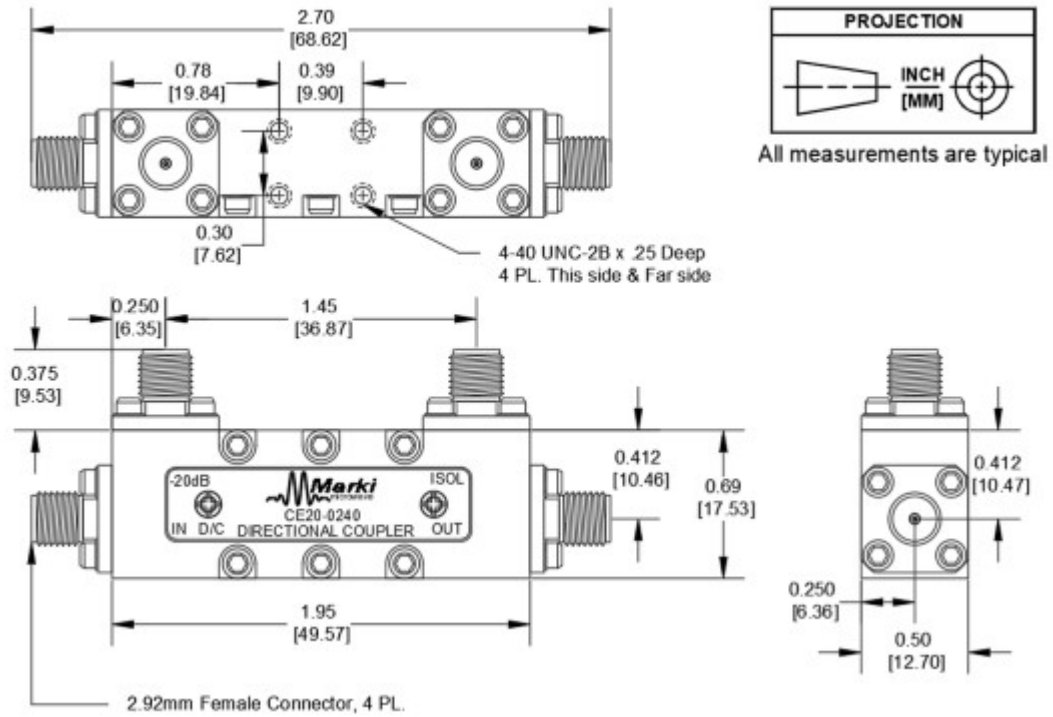

DISCLAIMER

MARKI MICROWAVE, LLC., ("MARKI") PROVIDES TECHNICAL SPECIFICATIONS AND DATA (INCLUDING DATASHEETS), APPLICATION OR OTHER DESIGN ADVICE, WEB TOOLS, AND OTHER INFORMATION AND RESOURCES "AS IS" AND WITH ALL FAULTS. MARKI DISCLAIMS ALL WARRANTIES, EXPRESS OR IMPLIED, INCLUDING, WITHOUT LIMITATION, ANY IMPLIED WARRANTIES OF MERCHANTABILITY, FITNESS FOR A PARTICULAR PURPOSE, OR NON-INFRINGEMENT.

These resources are intended for developers skilled in the art designing with Marki products. You are solely responsible for (1) selecting the appropriate products for your application, (2) designing, validating, and testing your application, and (3) ensuring your application meets applicable standards and other requirements. Marki makes no guarantee regarding the suitability of its products for any particular purpose, nor does Marki assume any liability whatsoever arising out of your use or application of any Marki product.

Marki grants you permission to use these resources only for development of an application that uses Marki products. Other reproduction or use of these resources is strictly prohibited. No license is granted to any other Marki intellectual property or to any third-party intellectual property. Marki reserves the right to make changes to the product(s) or information contained herein without notice.

MARKI MICROWAVE and T3 MIXER are trademarks or registered trademarks of Marki Microwave, LLC. All other trademarks used are the property of their respective owners.

© 2021 - 2022, Marki Microwave, LLC