

MFB-3300CH

Passive MMIC 26-40GHz Bandpass Filter

DEVICE OVERVIEW

General Description

The MFB-3300 is a passive MMIC bandpass filter. It is a low loss integrated filter that passes the Ka (26-40GHz) band. Passive GaAs MMIC technology allows production of smaller filter constructions that replace larger form factor circuit board constructions. Tight fabrication tolerances allow for less unit to unit variation than traditional filter technologies. The MFB-3300 is available as a wire bondable chip. Low unit to unit variation allow for accurate simulations using the provided S2P file taken from measured production units.

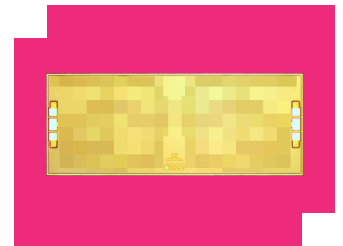

[Download s-parameters here](#)

Features

- Designed for Ka Band
- Insertion Loss Typically 1.5dB at Center Frequency
- Excellent Return Loss
- High Stop Band Suppression
- Wide Stop Band

Applications

N/A

Functional Block Diagram

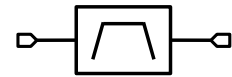

Part Ordering Options

Part Number	Description	Package	Green Status	Product Lifecycle	Export Classification
MFB-3300CH	Passive MMIC 26-40GHz Bandpass Filter	CH	REACH RoHS	Released	EAR99

Table Of Contents

- **Device Overview**
 - General Description
 - Features
 - Applications
 - Functional Block Diagram
- **Port Configuration and Functions**
 - Port Diagram
 - Port Functions
- **Revision History**
- **Specifications**
 - Absolute Maximum Ratings
 - Package Information
 - Electrical Specifications
 - Typical Performance Plots
- **Die Mounting Recommendations**
 - Mounting and Bounding Recommendations
- **Mechanical Data**
 - Outline Drawing
- **Notes**

Revision History

Revision Code	Revision Date	Comment
-	2023-05-22	Datasheet Initial Release

Port Configuration and Functions

Port Diagram

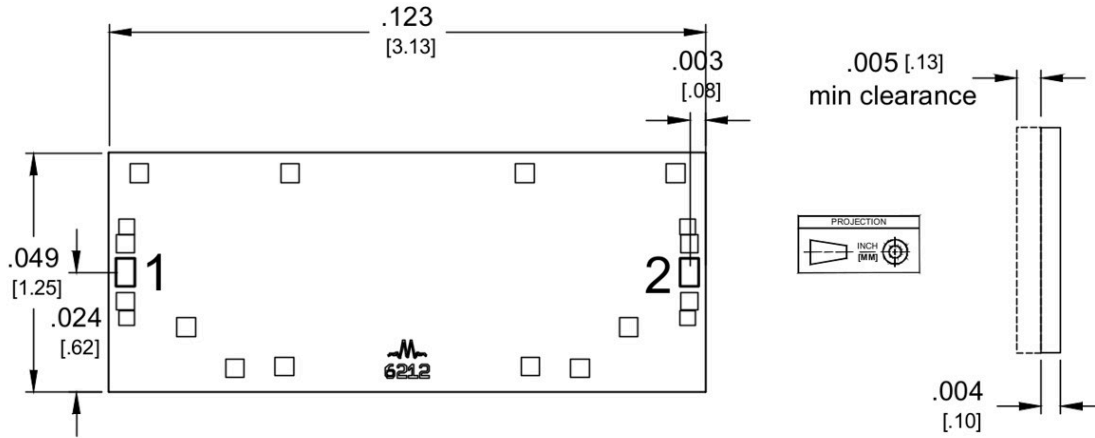

1. CH Substrate material is .004 thick GaAs.
2. I/O traces finish is 5 microns Au. Ground plane finish is 4 microns Au.
3. Wire Bonding - Ball or wedge bond with 0.025 mm (1 mil) diameter pure gold wire. Thermosonic wirebonding with a nominal stage temperature of 150 °C and a ball bonding force of 40 to 50 grams or wedge bonding force of 18 to 22 grams is recommended. Use the minimum level of ultrasonic energy to achieve reliable wirebonds. Wirebonds should be started on the chip and terminated on the package or substrate. All bonds should be as short as possible <0.31 mm (12 mils).

Port Functions

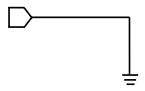
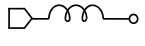
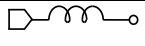
Port	Function	Description	Equivalent Circuit for Package
Pad	Ground	CH package ground path is provided through the substrate and ground bond pads.	
Port 1	Input/Output	Port 1 is DC open to ground for the CH package.	
Port 2	Input/Output	Port 2 is DC open to ground for the CH package.	

Specifications

Absolute Maximum Ratings

Exposure to maximum rating conditions for extended periods may reduce device reliability. There is no damage to device with only one parameter set at the limit and all other parameters set at or below their nominal value. Exceeding any of the limits listed here may result in permanent damage to the device.

Parameter	Maximum Rating	Unit
Maximum Operating Temperature	125	°C
Maximum Storage Temperature	125	°C
Minimum Operating Temperature	-65	°C
Minimum Storage Temperature	-65	°C
RF Power Handling	30	dBm
Spec Guaranteed Operating Temperature	25	°C

Package Information

Parameter	Details	Rating
Dimensions	-	3.13 x 1.25 mm

Electrical Specifications

Specifications guaranteed +25°C for chip (CH) package, measured in a 50Ω system.

Parameter	Test Conditions	Minimum Frequency (GHz)	Maximum Frequency (GHz)	Min	Typ	Max	Unit
1 dBc Passband	Configuration A, Temp = 25°C	26.3	39.37	-	-	-	GHz
3 dBc Passband	Configuration A, Temp = 25°C	25.38	40.79	-	-	-	GHz
30 dBc Rejection Point	Configuration A, Temp = 25°C	18.35	45.06	-	-	-	GHz
Center Freq	Configuration A, Temp = 25°C	-	-	-	32.18	-	GHz
Insertion Loss @ fc	Configuration A, Temp = 25°C	-	-	-	1.3	3.0	dB
Passband Return Loss	Configuration A, Temp = 25°C	-	-	-	17	-	dB
Group Delay	Configuration A, Temp = 25°C	-	-	-	98	-	ps
Impedance	Configuration A, Temp = 25°C	-	-	-	50	-	Ω
Stopband Suppression	-	18.7	44.8	25	30	-	dB
Stopband Suppression	-	11.1	50	40	50	-	dB

Typical Performance Plots

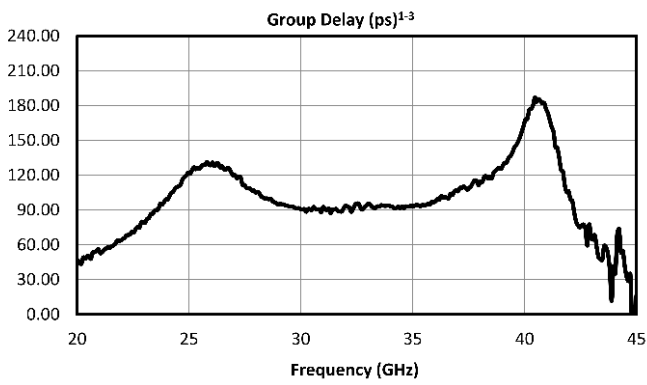
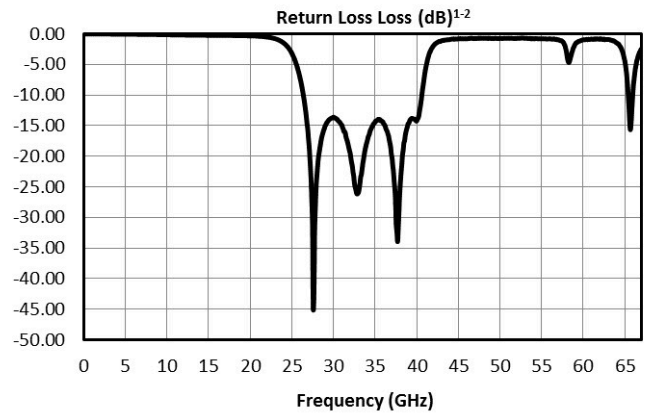
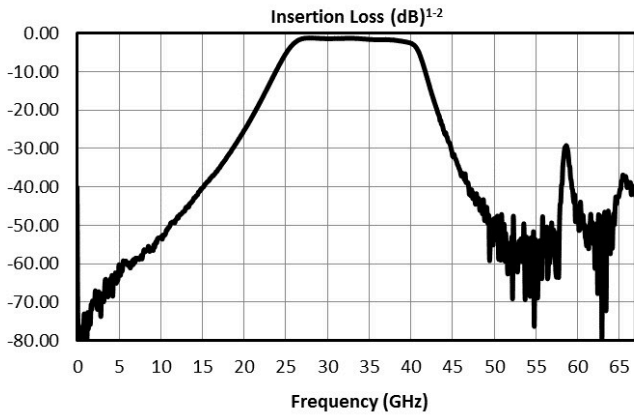

Die Mounting Recommendations

Mounting and Bonding Recommendations

Marki MMICs should be attached directly to a ground plane with conductive epoxy. The ground plane electrical impedance should be as low as practically possible. This will prevent resonances and permit the best possible electrical performance. Datasheet performance is only guaranteed in an environment with a low electrical impedance ground. 4

Mounting - To epoxy the chip, apply a minimum amount of conductive epoxy to the mounting surface so that a thin epoxy fillet is observed around the perimeter of the chip. Cure epoxy according to manufacturer instructions.

Wire Bonding - Ball or wedge bond with 0.025 mm (1 mil) diameter pure gold wire. Thermosonic wirebonding with a nominal stage temperature of 150 °C and a ball bonding force of 40 to 50 grams or wedge bonding force of 18 to 22 grams is recommended. Use the minimum level of ultrasonic energy to achieve reliable wirebonds. Wirebonds should be started on the chip and terminated on the package or substrate. All bonds should be as short as possible <0.31 mm (12 mils).

Circuit Considerations – 50 Ω transmission lines should be used for all high frequency connections in and out of the chip. Wirebonds should be kept as short as possible, with multiple wirebonds recommended for higher frequency connections to reduce parasitic inductance. In circumstances where the chip more than .001” thinner than the substrate, a heat spreading spacer tab is optional to further reduce bondwire length and parasitic inductance.

Handling Precautions

General Handling: Chips should be handled with a vacuum collet when possible, or with sharp tweezers using well trained personnel. The surface of the chip is fragile and should not be contacted if possible.

Static Sensitivity: GaAs MMIC devices are subject to static discharge, and should be handled, assembled, tested, and transported only in static protected environments.

Cleaning and Storage: Do not attempt to clean the chip with a liquid cleaning system or expose the bare chips to liquid. Once the ESD sensitive bags the chips are stored in are opened, chips should be stored in a dry nitrogen atmosphere.

Bonding Diagram

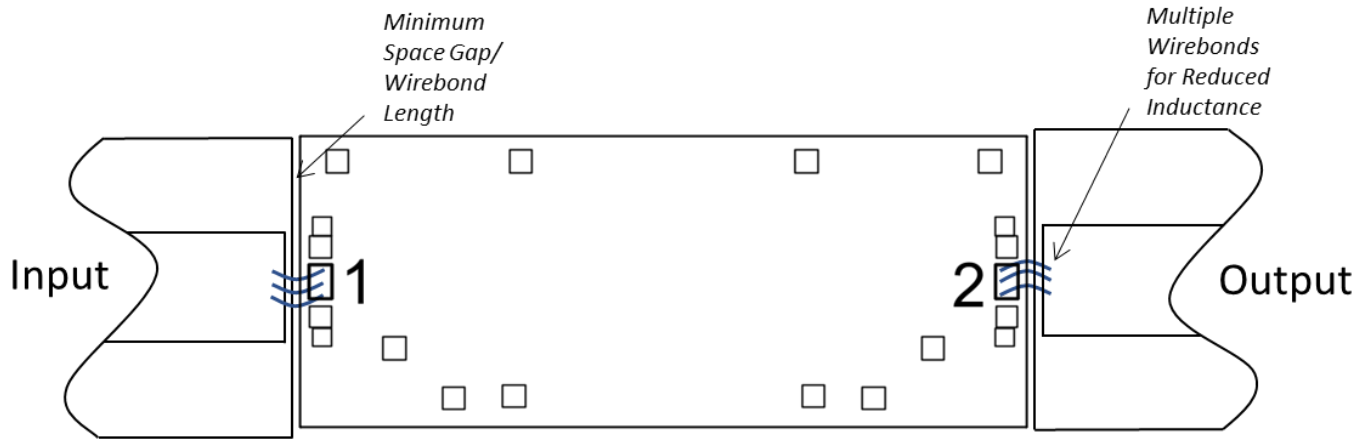

Mechanical Data

Outline Drawing

Download : [Outline 2D Drawing](#)

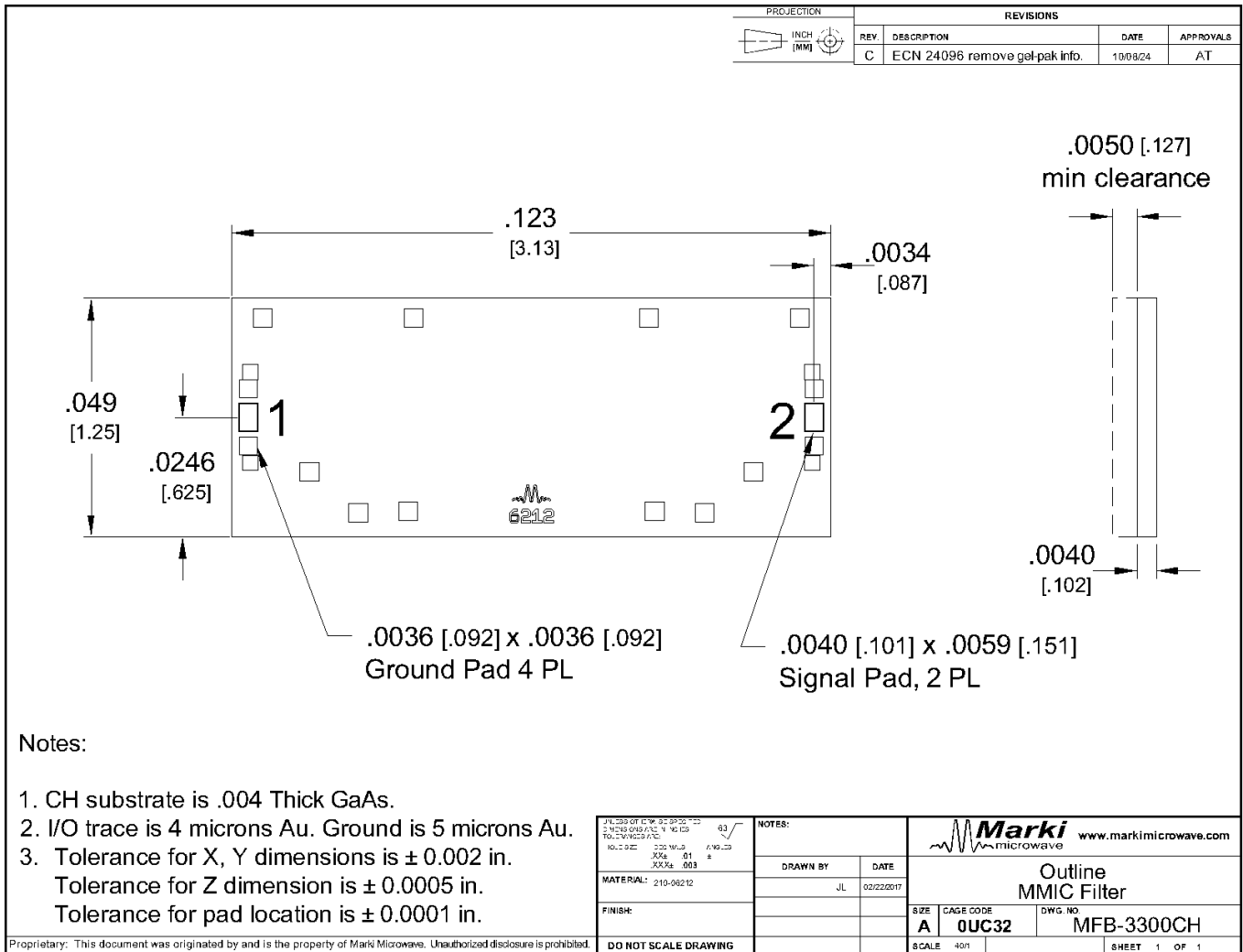

Notes

1. Filter is symmetrical. Reverse measurement is equivalent to forward measurement.
2. Measured typical data available for integrated circuit only.
3. Group delay calculated using wrapped phase response.
4. Specifications are subject to change without notice. Contact Marki Microwave for the most recent specifications and data sheets.
5. Catalog circuits are continually improved. Configuration control requires custom model numbers and specifications.

DISCLAIMER

MARKI MICROWAVE, INC., ("MARKI") PROVIDES TECHNICAL SPECIFICATIONS AND DATA (INCLUDING DATASHEETS), APPLICATION OR OTHER DESIGN ADVICE, WEB TOOLS, AND OTHER INFORMATION AND RESOURCES "AS IS" AND WITH ALL FAULTS. MARKI DISCLAIMS ALL WARRANTIES, EXPRESS OR IMPLIED, INCLUDING, WITHOUT LIMITATION, ANY IMPLIED WARRANTIES OF MERCHANTABILITY, FITNESS FOR A PARTICULAR PURPOSE, OR NON-INFRINGEMENT. These resources are intended for developers skilled in the art designing with Marki products. You are solely responsible for (1) selecting the appropriate products for your application, (2) designing, validating, and testing your application, and (3) ensuring your application meets applicable standards and other requirements. Marki makes no guarantee regarding the suitability of its products for any particular purpose, nor does Marki assume any liability whatsoever arising out of your use or application of any Marki product.

Marki grants you permission to use these resources only for development of an application that uses Marki products. Other reproduction or use of these resources is strictly prohibited. No license is granted to any other Marki intellectual property or to any third-party intellectual property. Marki reserves the right to make changes to the product(s) or information contained herein without notice.

MARKI MICROWAVE and T3 MIXER are trademarks or registered trademarks of Marki Microwave, Inc. All other trademarks used are the property of their respective owners.

© 2023, Marki Microwave, Inc