

MQH-0612CSP3

MMIC 6 - 12 GHz 90° Hybrid Coupler

DEVICE OVERVIEW

General Description

The MQH-0612CSP3 is a MMIC 6 - 12 GHz quadrature hybrid. Passive GaAs MMIC technology allows production of smaller constructions that replace larger form factor circuit board constructions. The MQH-0612CSP3 exhibits excellent amplitude balance with broadband quadrature phasing between output ports. Low variation allows for accurate simulations using the provided S4P file taken from measured production units. Tight fabrication tolerances allow for less unit to unit variation than traditional splitter/combiner technologies.

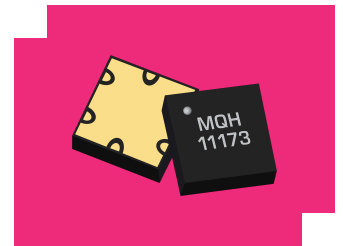

Features

- Designed for C/X-band applications
- Excellent amplitude and phase balance
- High isolation
- Low insertion loss

Applications

N/A

Functional Block Diagram

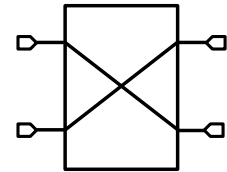

Part Ordering Options

Part Number	Description	Package	Green Status	Product Lifecycle	Export Classification
MQH-0612CSP3	MMIC 6 - 12 GHz 90° Hybrid Coupler	CSP3	RoHS REACH	Released	EAR99
<u>EVB-MQH-0612</u>	Evaluation Board, 6 - 12 GHz MMIC 90° Hybrid Coupler	EVB	RoHS REACH	Released	EAR99

Table Of Contents

<ul style="list-style-type: none"> ■ Device Overview <ul style="list-style-type: none"> General Description Features Applications Functional Block Diagram ■ Port Configuration and Functions <ul style="list-style-type: none"> Port Diagram Port Functions ■ Revision History 	<ul style="list-style-type: none"> ■ Specifications <ul style="list-style-type: none"> Absolute Maximum Ratings Package Information Electrical Specifications Typical Performance Plots ■ Mechanical Data <ul style="list-style-type: none"> Outline Drawing ■ Footprint Image ■ Evaluation Board <ul style="list-style-type: none"> Evaluation Board Outline Drawing
---	--

Revision History

Revision Code	Revision Date	Comment
-	2026-04-16	Initial Release

Port Configuration and Functions

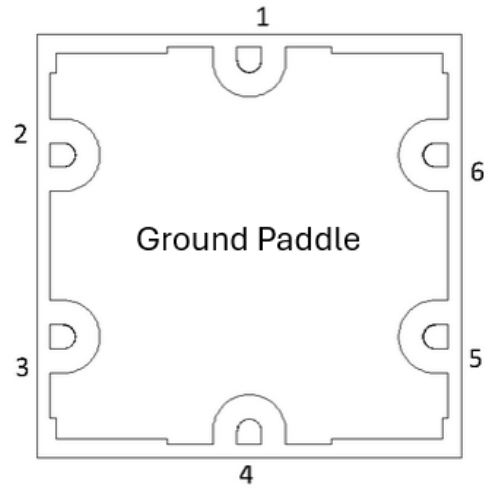

Port Diagram

X-RAY VIEW CSP PACKAGE



Port Functions

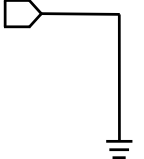
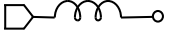
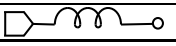

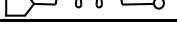
Configuration A

Port	Function	Description	DC Equivalent Circuit
Ground Paddle	Gnd	Ground paddle should be connected to RF ground	
Pin 1	NC	Pin 1 is not internally connected. It can be connected to ground for normal operation.	-
Pin 2	Isolated	Pin 2 is isolated from the input. It is DC open to the other pins and open to ground. It should be connected to a 50 Ω load for normal operation.	
Pin 3	RF Input	Pin 3 is used as input. It is DC open to the other pins and open to ground.	
Pin 4	NC	Pin 4 is not internally connected. It can be connected to ground for normal operation.	-
Pin 5	90° Output	Pin 5 is 90° output. It is DC open to the other pins and open to ground.	
Pin 6	0° Output	Pin 6 is 0° output. It is DC open to the other 4 pins and open to ground.	

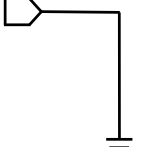
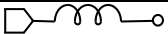
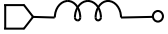
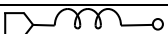
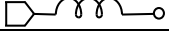
Configuration B

Port	Function	Description	DC Equivalent Circuit
Ground Paddle	Gnd	Ground paddle should be connected to RF ground	
Pin 1	NC	Pin 1 is not internally connected. It can be connected to ground for normal operation.	-
Pin 2	RF Input	Pin 2 is used as input. It is DC open to the other pins and open to ground.	
Pin 3	Isolated	Pin 3 is isolated from the input. It is DC open to the other pins and open to ground. It should be connected to a 50 Ω load for normal operation.	
Pin 4	NC	Pin 4 is not internally connected. It can be connected to ground for normal operation.	-
Pin 5	0° Output	Pin 5 is 0° output. It is DC open to the other 4 pins and open to ground.	
Pin 6	90° Output	Pin 6 is 90° output. It is DC open to the other pins and open to ground.	

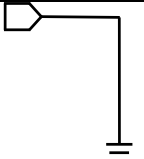
Configuration C

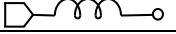
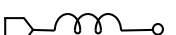
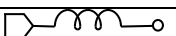
Port	Function	Description	DC Equivalent Circuit
Ground Paddle	Gnd	Ground paddle should be connected to RF ground	
Pin 1	NC	Pin 1 is not internally connected. It can be connected to ground for normal operation.	-
Pin 2	90° Output	Pin 2 is 90° output. It is DC open to the other pins and open to ground.	
Pin 3	0° Output	Pin 3 is 0° output. It is DC open to the other 4 pins and open to ground.	
Pin 4	NC	Pin 4 is not internally connected. It can be connected to ground for normal operation.	-
Pin 5	Isolated	Pin 5 is isolated from the input. It is DC open to the other pins and open to ground. It should be connected to a 50 Ω load for normal operation.	
Pin 6	RF Input	Pin 6 is used as input. It is DC open to the other pins and open to ground	

Configuration D

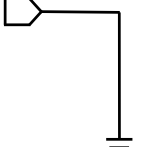
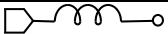
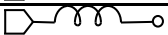
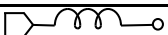
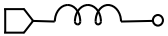
Port	Function	Description	DC Equivalent Circuit
Ground Paddle	Gnd	Ground paddle should be connected to RF ground	
Pin 1	NC	Pin 1 is not internally connected. It can be connected to ground for normal operation.	-
Pin 2	0° Output	Pin 2 is 0° output. It is DC open to the other 4 pins and open to ground.	
Pin 3	90° Output	Pin 3 is 90° output. It is DC open to the other pins and open to ground.	
Pin 4	NC	Pin 4 is not internally connected. It can be connected to ground for normal operation.	-
Pin 5	RF Input	Pin 5 is used as input. It is DC open to the other pins and open to ground.	
Pin 6	Isolated	Pin 6 is isolated from the input. It is DC open to the other pins and open to ground. It should be connected to a 50 Ω load for normal operation.	

Specifications

Absolute Maximum Ratings

The Absolute Maximum Ratings indicate limits beyond which damage may occur to the device. If these limits are exceeded, the device may be inoperable or have a reduced lifetime.

Parameter	Maximum Rating	Unit
Maximum Operating Temperature	100	°C
Maximum Storage Temperature	125	°C
Minimum Operating Temperature	-55	°C
Minimum Storage Temperature	-65	°C
RF Power Handling	45	dBm

Package Information

Parameter	Details	Rating
ESD	< 250 Volts	HBM Class 0
Dimensions	-	3.50 x 3.50 mm
Moisture Sensitivity Level	-	MSL 1

Electrical Specifications

Parameter	Port Configuration	Test Conditions	Minimum Frequency (GHz)	Maximum Frequency (GHz)	Min	Typ	Max	Unit
Amplitude Balance	A	Configuration A	6	12	-	0.5	-	dB
Impedance	-	All Ports	6	12	-	50	-	Ω
Isolation	A	Configuration A	6	12	-	27	-	dB
Mean Coupling	-	-	6	12	-	3	-	dB
Nominal Phase Shift	-	-	6	12	-	90	-	°
Phase Balance	A	Configuration A	6	12	-	0.5	-	°
Excess Insertion Loss	A	Configuration A	6	12	-	0.6	-	dB
Return Loss	-	All Ports	6	12	-	26	-	dB

Excess Insertion Loss = Input to Output Insertion Loss - 3dB

Typical performance plots shown for port configuration A. Performance may vary in alternate configurations.

Typical Performance Plots

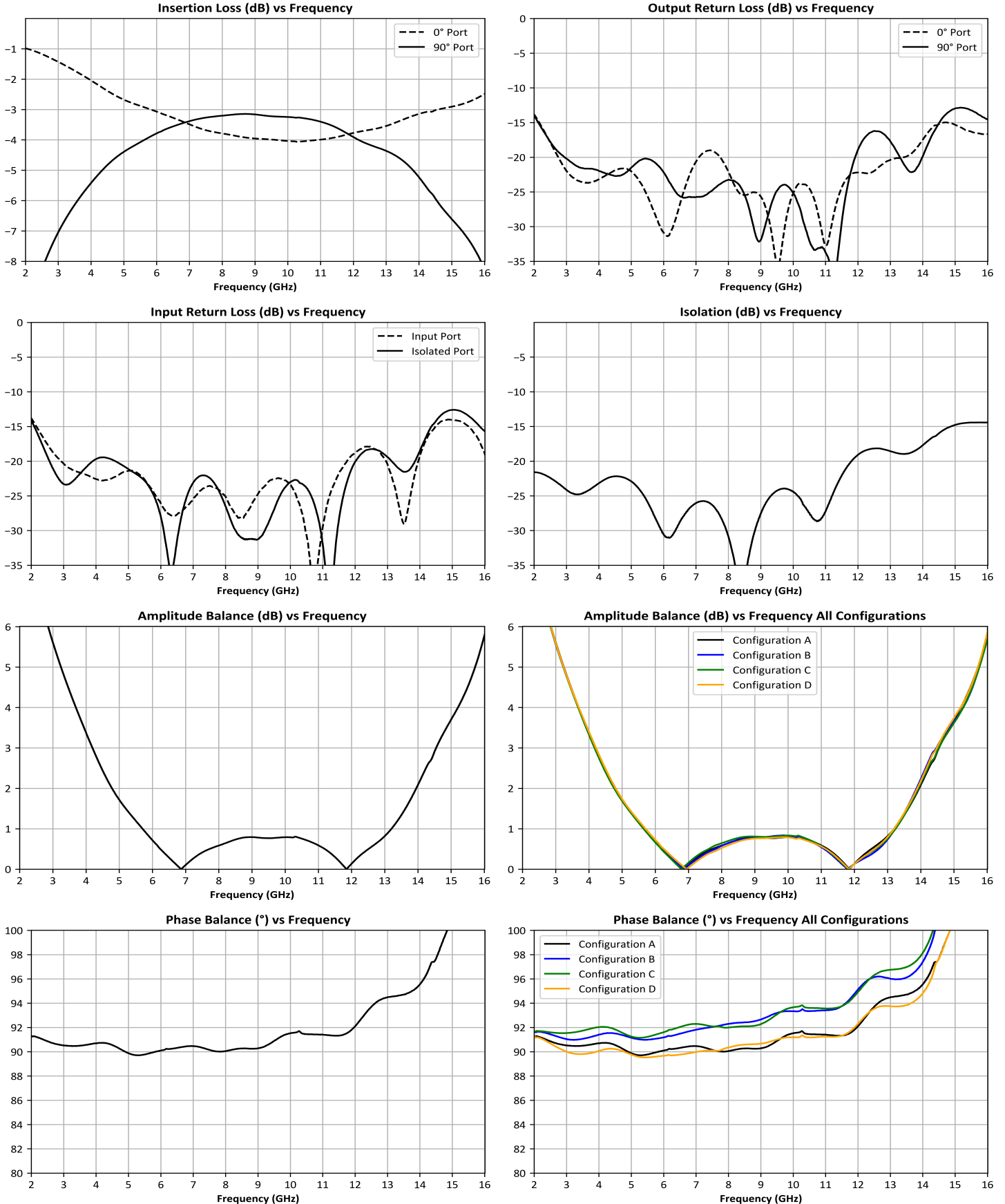

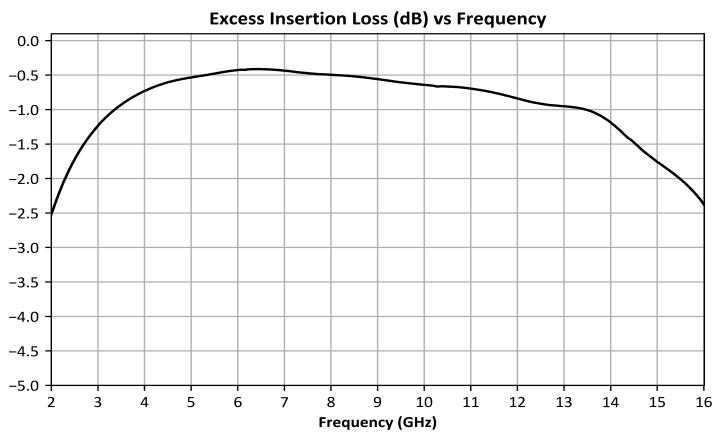

Footprint Image

Download : [Footprint Drawing](#)

CSP3 Package Sample Drawing X-Ray view

Pin#	Function
1	NC
2	iso
3	Input
4	NC
5	*50
6	*0

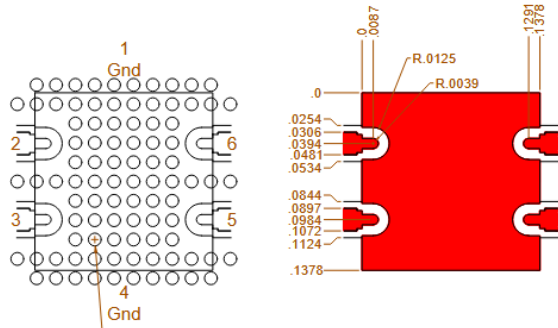
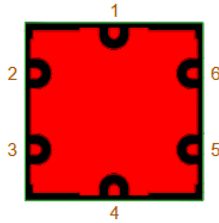

Launch pattern sample below.
Grounded Coplanar wave guide
with 5.3mil slot. All Places.

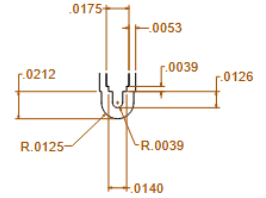

Ø.0100
Plated thru via, 92 PL. Recommended conductive or non-conductive fill. Vias can be added or reduced at PCB designer's discretion.

DISCLAIMER

MARKI MICROWAVE, LLC., ("MARKI") PROVIDES TECHNICAL SPECIFICATIONS AND DATA (INCLUDING DATASHEETS), APPLICATION OR OTHER DESIGN ADVICE, WEB TOOLS, AND OTHER INFORMATION AND RESOURCES "AS IS" AND WITH ALL FAULTS. MARKI DISCLAIMS ALL WARRANTIES, EXPRESS OR IMPLIED, INCLUDING, WITHOUT LIMITATION, ANY IMPLIED WARRANTIES OF MERCHANTABILITY, FITNESS FOR A PARTICULAR PURPOSE, OR NON-INFRINGEMENT.

These resources are intended for developers skilled in the art designing with Marki products. You are solely responsible for (1) selecting the appropriate products for your application, (2) designing, validating, and testing your application, and (3) ensuring your application meets applicable standards and other requirements. Marki makes no guarantee regarding the suitability of its products for any particular purpose, nor does Marki assume any liability whatsoever arising out of your use or application of any Marki product.

Marki grants you permission to use these resources only for development of an application that uses Marki products. Other reproduction or use of these resources is strictly prohibited. No license is granted to any other Marki intellectual property or to any third-party intellectual property. Marki reserves the right to make changes to the product(s) or information contained herein without notice.

MARKI MICROWAVE and T3 MIXER are trademarks or registered trademarks of Marki Microwave, LLC. All other trademarks used are the property of their respective owners.

© 2026, Marki Microwave, LLC