

MM1A-1855HPSM-2

Double Balanced Mixer/LO Amplifier

DEVICE OVERVIEW

General Description

The MM1A-1855HPSM is a versatile, robust, and broadband double balanced mixer with an integrated broadband LO driver amplifier. The MM1A-1855HPSM is ideal for applications with wide bandwidths and operation at mmWave frequencies. The integrated LO driver amplifier allows for operation with LO powers as low as +4dBm while retaining exceptional conversion loss and linearity.

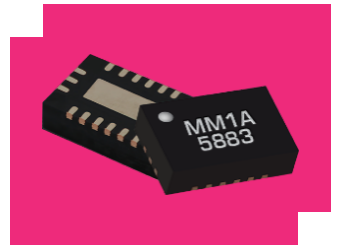

Features

- RF/LO response: 18GHz - 55GHz
- IF response: DC – 21GHz
- Conversion Loss: 9 dB
- Minimum LO drive: +4dBm

Applications

- Test and Measurement Equipment
- SATCOM
- Radar
- 5G

Functional Block Diagram

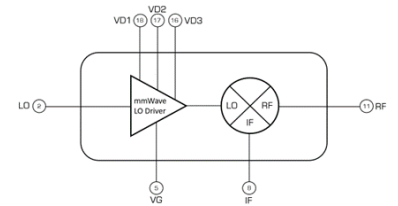

Part Ordering Options

Part Number	Description	Package	Green Status	Product Lifecycle	Export Classification
MM1A-1855HPSM-2	Double Balanced Mixer/LO Amplifier	QFN	REACH RoHS	Released	EAR99
EVB-MM1A-1855HP	Evaluation Board, Double Balanced Mixer/LO Amplifier	EVB	REACH RoHS	Released	EAR99

Table Of Contents

- **Device Overview**
 - General Description
 - Features
 - Applications
 - Functional Block Diagram
- **Port Configuration and Functions**
 - Port Diagram
 - Port Functions
- **Revision History**
- **Specifications**
 - Absolute Maximum Ratings
 - Package Information
 - Recommended Operating Conditions
 - Sequencing Requirements
 - Electrical Specifications
 - Typical Performance Plots
 - Spur Tables
- **Operation**
 - Application Circuit
 - Application Circuit Description
- **Mechanical Data**
 - Outline Drawing
- **Footprint Image**
- **Evaluation Board**
 - Evaluation Board Outline Drawing
 - Evaluation Board - Application Circuit

Revision History

Revision Code	Revision Date	Comment
-	2022-09-01	Datasheet Initial Release
A	2024-09-11	Updated Recommended Power Supply Voltage
B	2026-01-12	MSL updated from MSL3 to MSL1.

Port Configuration and Functions

Port Diagram

A top-down x-ray view of the MM1A-1855HPSM's PSM Package outline drawing is shown below. The MM1A-1855HPSM has the input and output ports given in Port Functions.

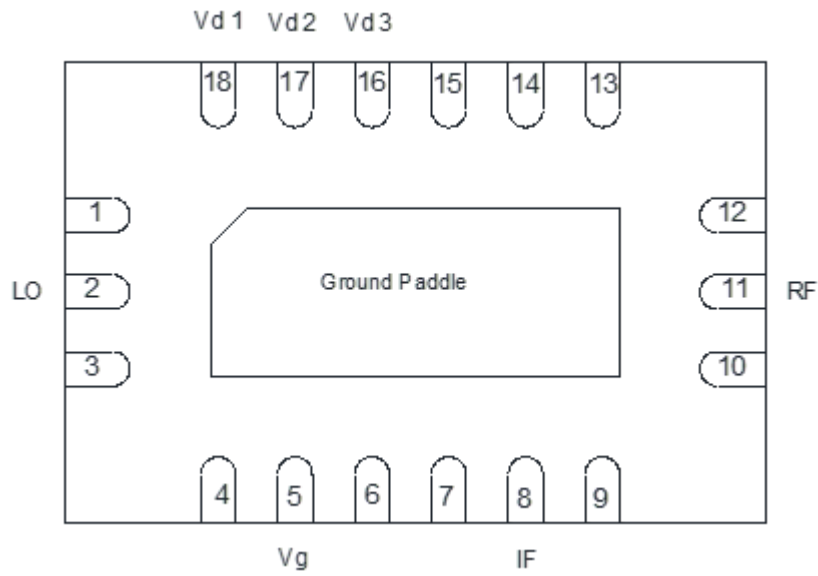

Port Functions

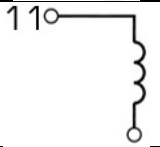
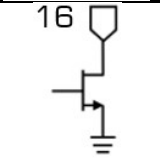
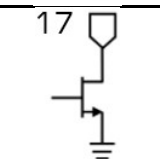
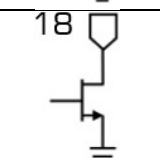
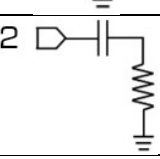
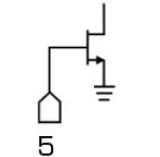
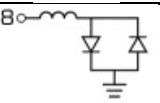
Port	Function	Description	DC Equivalent Circuit
GND	Ground	Ground paddle and non-connected pins must be connected to a DC/RF ground potential with high thermal and electrical conductivity, and low inductance.	GND 
Pin 11	RF	Pin 11 is DC open and AC matched to 50 Ohms from 18 to 55 GHz. Blocking capacitor is optional.	11 
Pin 16	Positive DC Supply Vd	Pins 16 provides +2.5V to +4V DC voltage to the amplifier's third stage. Negative voltage must be supplied to Pin 5 before turning on the positive supply voltage.	16 
Pin 17	Positive DC Supply Vd	Pins 17 provides +2.5V to +4V DC voltage to the amplifier's second stage. Negative voltage must be supplied to Pin 5 before turning on the positive supply voltage.	17 
Pin 18	Positive DC Supply Vd	Pins 18 provides +2.5V to +4V DC voltage to the amplifier's first stage. Negative voltage must be supplied to Pin 5 before turning on the positive supply voltage.	18 
Pin 2	LO	Pin 2 is the input of the integrated LO driver amplifier and is matched to 50 ohms. It is internally DC blocked.	2 
Pin 5	Negative DC Supply Vg	Pin 5 requires -0.4V to -0.6V of DC voltage. This must be turned on before turning on the positive supply voltage to Pin 5.	5 
Pin 8	IF	Pin 8 is DC coupled to the diodes. Blocking capacitor is optional.	8 

Specifications

Absolute Maximum Ratings

The Absolute Maximum Ratings indicate limits beyond which damage may occur to the device. All limits are individual and should not be met in parallel, doing so will degrade the lifetime of the device. If these limits are exceeded, the device may be inoperable or have a reduced lifetime.

Parameter	Maximum Rating	Unit
DC Voltage on VD	4.5	V
DC Voltage on VG	-2	V
LO Power Handling	20	dBm
Maximum Operating Temperature	85	°C
Maximum Storage Temperature	125	°C
Max Junction Temperature for MTTF > 1E6 hours	175	°C
Minimum Operating Temperature	-40	°C
Minimum Storage Temperature	-65	°C
Positive Drain Supply Current with RF Input (Id)	450	mA
RF Power Handling	25	dBm
θ_{JC} , Junction to Case Thermal Resistance	94	°C/W

Package Information

Parameter	Details	Rating
Dimensions	-	3 x 4.6 mm
Moisture Sensitivity Level	-	MSL 1

Recommended Operating Conditions

The Recommended Operating Conditions indicate the limits, inside which the device should be operated, to guarantee the performance given in Electrical Specifications. Operating outside these limits may not necessarily cause damage to the device, but the performance may degrade outside the limits of the electrical specifications. For limits, above which damage may occur, see Absolute Maximum Ratings.

Parameter	Min	Nominal	Max	Unit
Ambient Temperature	-55	25	85	°C
LO Input Power	4	6	10	dBm
Gate Bias DC Voltage (Vg)	-0.6	-0.5	-0.4	V
Saturated Current Draw	115	180	300	mA
Positive DC Voltage (Vd1)	2.5	3	4	V
Positive DC Voltage (Vd2)	2.5	3	4	V
Positive DC Voltage (Vd3)	2.5	3	-	V

Sequencing Requirements

Turn-on Procedure:

1. Apply Vg (Pin 5)
2. Apply Vd (Pin 16, Pin 17, Pin 18)

Turn Off:

1. Turn off Vd (Pin 16, Pin 17, Pin 18)
2. Turn off Vg (Pin 5)

Note: LO power can be injected at any moment in the bias sequencing procedure

Electrical Specifications

The electrical specifications apply at TA=+25°C in a 50Ω system. Typical data shown is for a down conversion application with a +6dBm LO input to the integrated LO driver amp biased at +3Vd1/+3Vd2/+3.5Vd3/-0.5Vg unless otherwise specified.

Parameter	Test Conditions	Min	Typ	Max	Unit
Conversion Loss ¹	RF/LO = 18 - 55 GHz I = 2 - 21 GHz	-	12	-	dB
Conversion Loss ²	RF/LO = 18 - 55 GHz I = DC - 2 GHz	-	9	15	dB
Current Consumption	+3Vd1/+3Vd2/+3.5Vd3/-0.5Vg	115	180	300	mA
IF Frequency Range	-	0	-	21	GHz
Input IP3	RF/LO = 18 - 55 GHz I = DC - 2 GHz	-	20	-	dBm
Input P1dB	-	-	9	-	dBm
LO Frequency Range	-	18	-	55	GHz
Noise Figure ³	RF/LO = 1.5 - 13 GHz I = DC - 2 GHz	-	9	-	dB
RF Frequency Range	-	18	-	55	GHz
RF-IF Isolation	RF/LO = 18 - 55 GHz	-	38	-	dB

^{[1][2]} Measured as a down converter to a fixed 91 MHz IF.

^[3] Mixer Noise Figure typically measures within 0.5 dB of conversion loss for IF frequencies greater than 5 MHz.

Typical Performance Plots

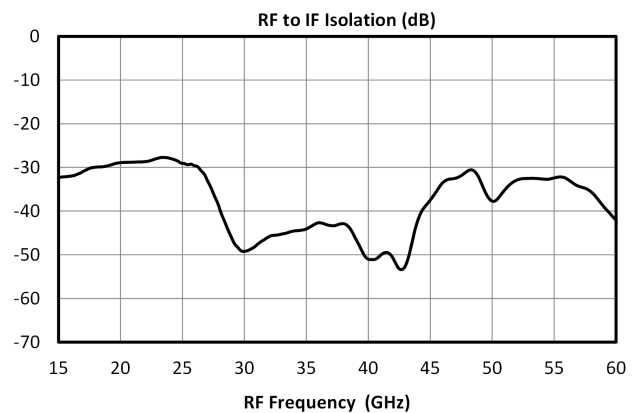
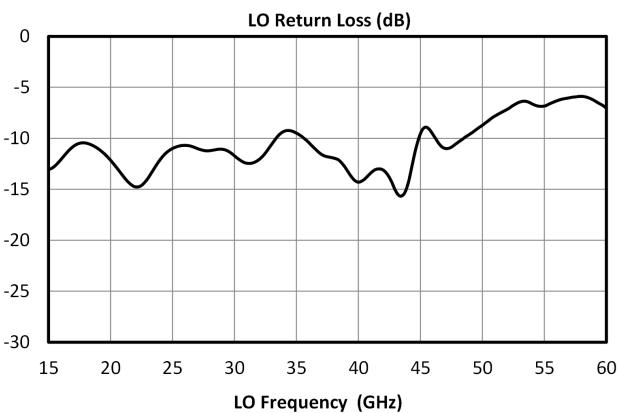
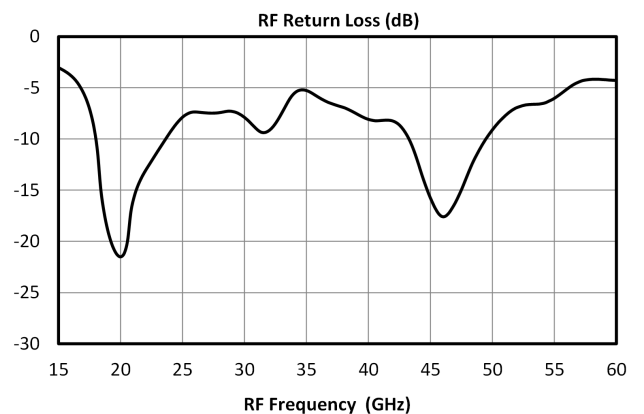
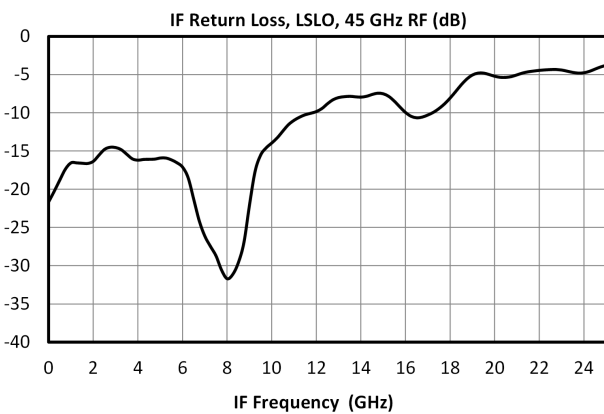
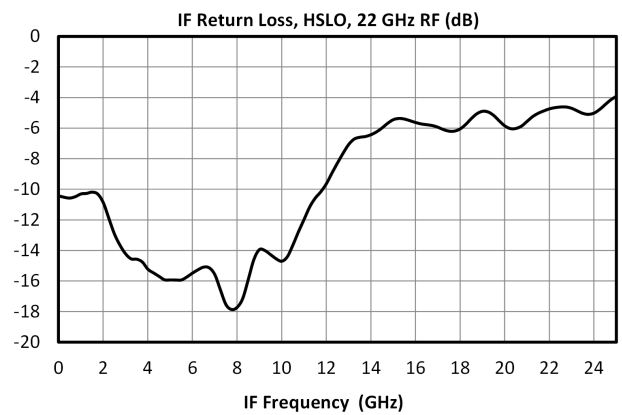
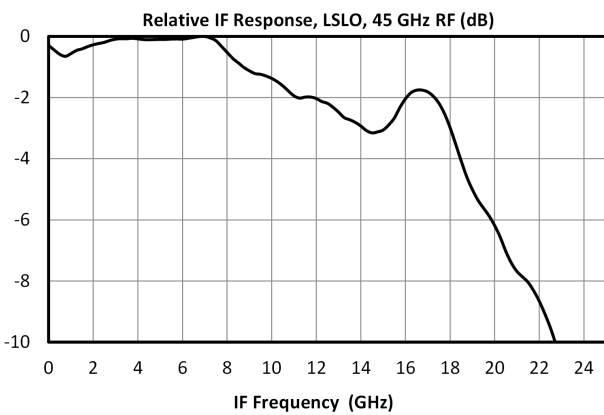
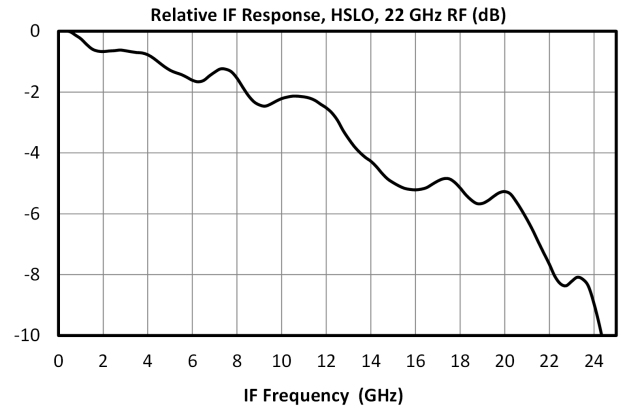
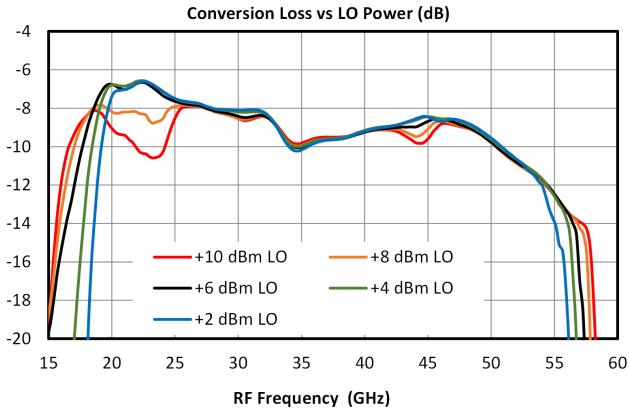

LO to RF Leakage (dBm)

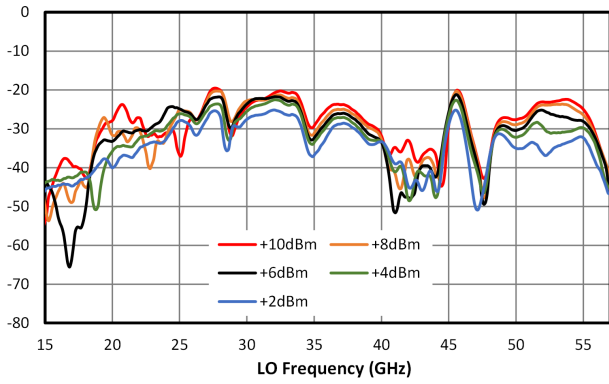

LO to IF Leakage (dBm)

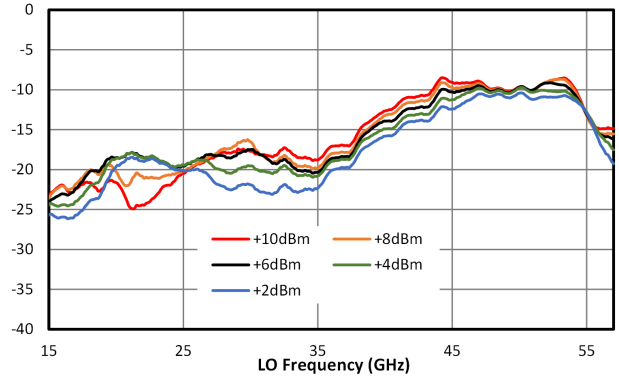

IIP3 vs LO Power (dBm)

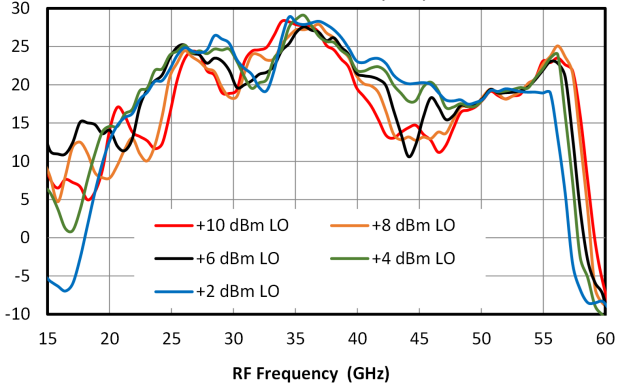

OIP3 vs LO Power (dBm)

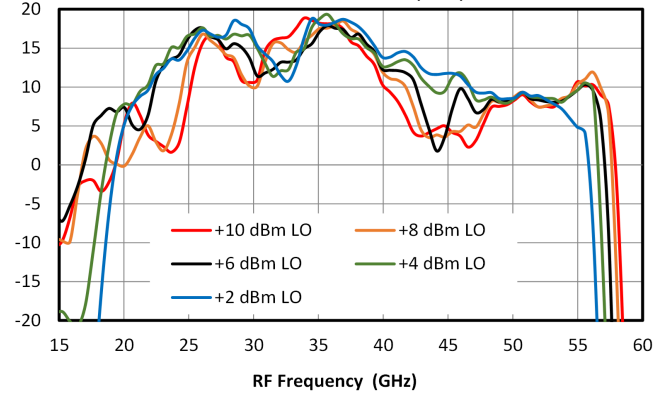

Even LO Harmonic to RF Leakage (dBm)

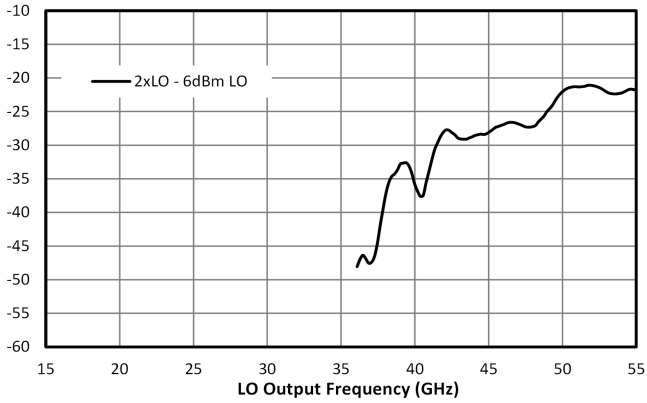

Even LO Harmonic to IF Leakage (dBm)

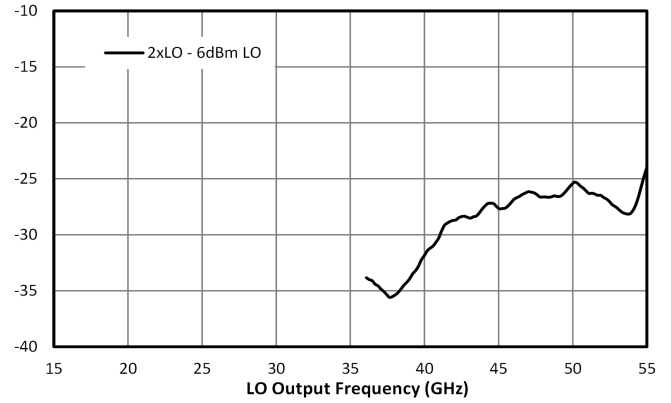

Odd LO Harmonic to RF Leakage (dBm)

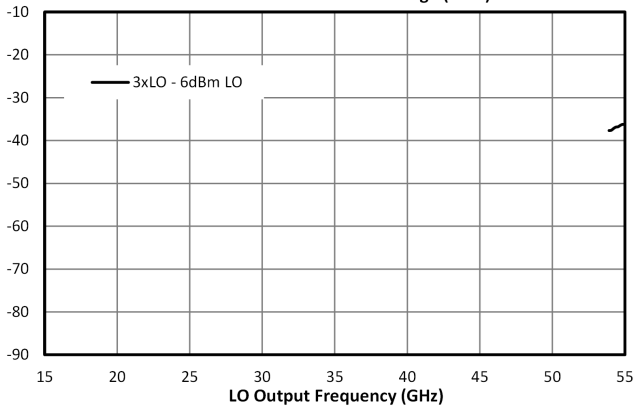

Odd LO Harmonic to IF Leakage (dBm)

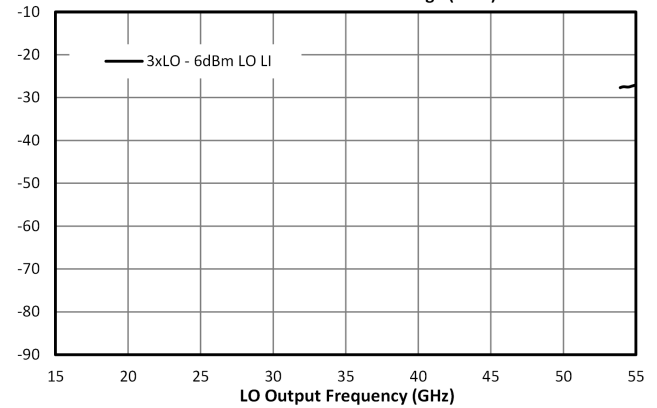

MM1A-1855HPSM-2

Double Balanced Mixer/LO Amplifier

2RF x 2LO Spurious Suppression (dBc) -10 dBm RF Input

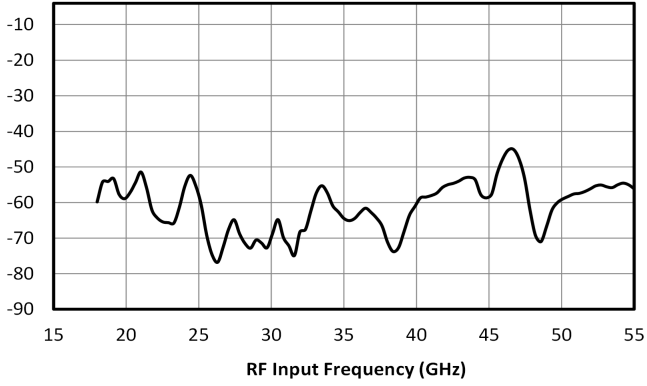

2IF x 1LO Spurious Suppression (dBc) -10 dBm IF Input

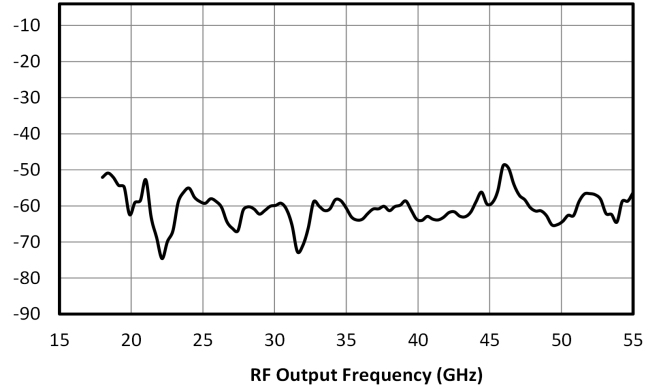

Drain Current (mA) vs. LO Input Power, (Vd=3V, Vg=-0.5V)

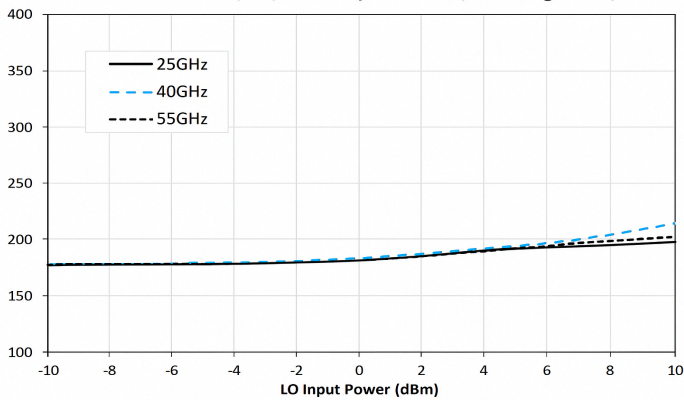

Spur Table

Typical Spurious Performance: Down-Conversion

Typical spurious data is provided by selecting RF and LO frequencies ($\pm m \cdot LO \pm n \cdot RF$) within the RF/LO bands, to create a spurious output within the IF band. The mixer is swept across the full spurious band and the mean is calculated. The numbers shown in the table below are for a -10 dBm RF input. Spurious suppression is scaled for different RF power levels by (n-1), where “n” is the RF spur order. For example, the 2RF x 2LO spur is 63 dBc for a -10 dBm input, so a -20 dBm RF input creates a spur that is (2-1) x (-10 dB) lower, or 73 dBc. Data is shown for the frequency plan in 3.6 Typical Performance. mLOx0RF plots can be found in section 3.6.2.

Typical Down-conversion spurious suppression (dBc)

-10 dBm RF Input	0xLO	1xLO	2xLO	3xLO	4xLO	5xLO
1xRF	31	Reference	22	19	25	N/A
2xRF	68	55	63	60	62	55
3xRF	87	58	74	72	80	72
4xRF	N/A	93	102	104	105	110
5xRF	N/A	N/A	97	120	118	116

Typical Spurious Performance: Up-Conversion

Typical spurious data is taken by mixing an input within the IF band, with LO frequencies ($\pm m \cdot LO \pm n \cdot IF$), to create a spurious output within the RF output band. The mixer is swept across the full spurious output band and the mean is calculated. The numbers shown in the table below are for a -10 dBm IF input. Spurious suppression is scaled for different IF input power levels by (n-1), where “n” is the IF spur order. For example, the 2IFx1LO spur is typically 57 dBc for a -10 dBm input with a sine-wave LO, so a -20 dBm IF input creates a spur that is (2-1) x (-10 dB) lower, or 67 dBc. Data is shown for the frequency plan in 3.6 Typical Performance.

Typical Up-conversion spurious suppression (dBc)

-10 dBm IF Input	0xLO	1xLO	2xLO	3xLO	4xLO	5xLO
1xIF	34	Reference	27	15	27	N/A
2xIF	68	57	57	56	55	64
3xIF	84	69	71	68	59	70
4xIF	118	104	97	102	100	107
5xIF	122	113	109	118	106	96

Application Circuit

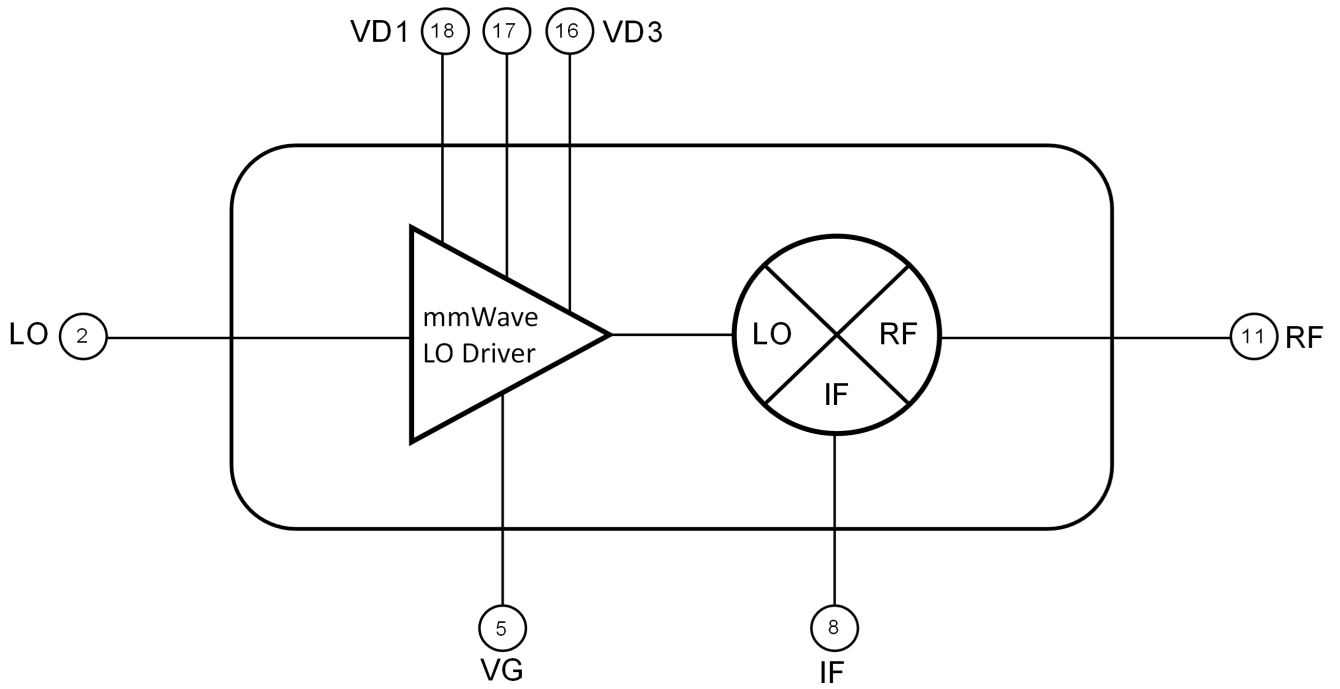

Application Circuit Description

Ports Operation

IF Port – Used as input on an upconversion, output on downconversion, or LO port in a band shifting application. Signals should be connected by 50 ohm microstrip or coplanar traces to well matched broadband 50 ohm sources and loads.

RF Port – Used as input on a downconversion, output on upconversion, or output in a band shifting application. Signals should be connected by 50 ohm microstrip or coplanar traces to well matched broadband 50 ohm sources and loads.

LO Port – The noise floor of the LO input signal should be less than the value of the noise floor plus isolation of the mixer, or a filter is recommended to prevent reduction in dynamic range. An integrated LO amplifier is included, allowing for superior performance with LO power below the typical recommended drive level.

Filtering and Matching- Filtering is generally desired for spurious and image removal on the output port of the mixer. Reflective filters can cause out of band signals to reflect back into the mixer and cause conversion loss ripple, erroneous spurs, and other undesired behaviors. To eliminate these problems it is recommended that the filters be placed as close to the output port as possible. If undesired behavior is still observed, a diplexer with one port terminated or a 1-3 dB attenuator may reduce this problem.

RF Ground – The ground paddle of the QFN should be connected to a low noise RF ground with very low electrical resistance for high frequency operation.

Mechanical Data

Outline Drawing

Download : [Outline 3D Drawing](#) | [Outline 3D STP](#)

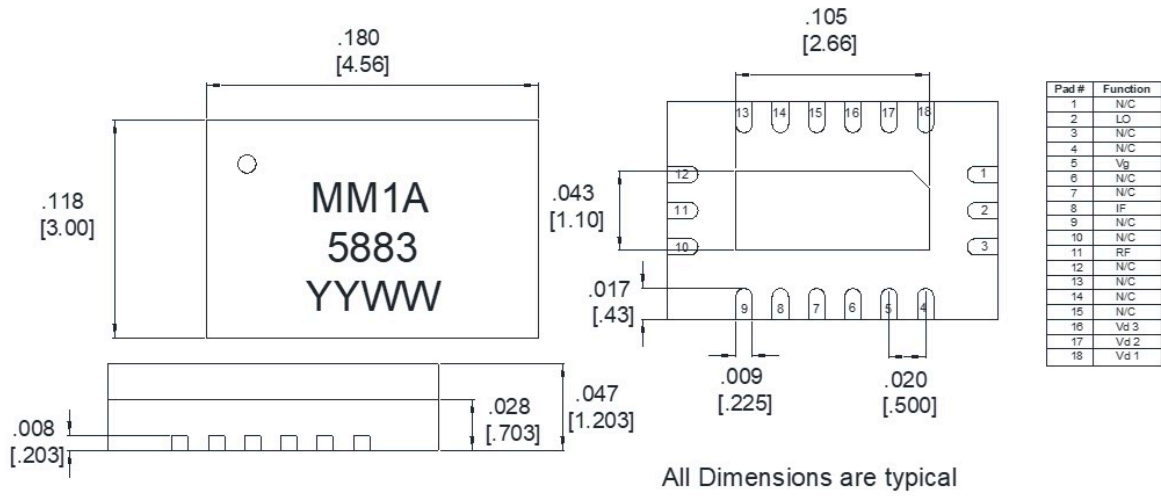

- Substrate material is LCP.
- I/O Leads and Die Paddle are: 0.003 microns Gold (MIN)
 - 0.08 - 0.15 microns Palladium
 - 0.5 - 2.0 microns Nickel.
- All unconnected pins should be connected to PCB RF ground.

Footprint Image

Download: [Footprint Drawing](#)

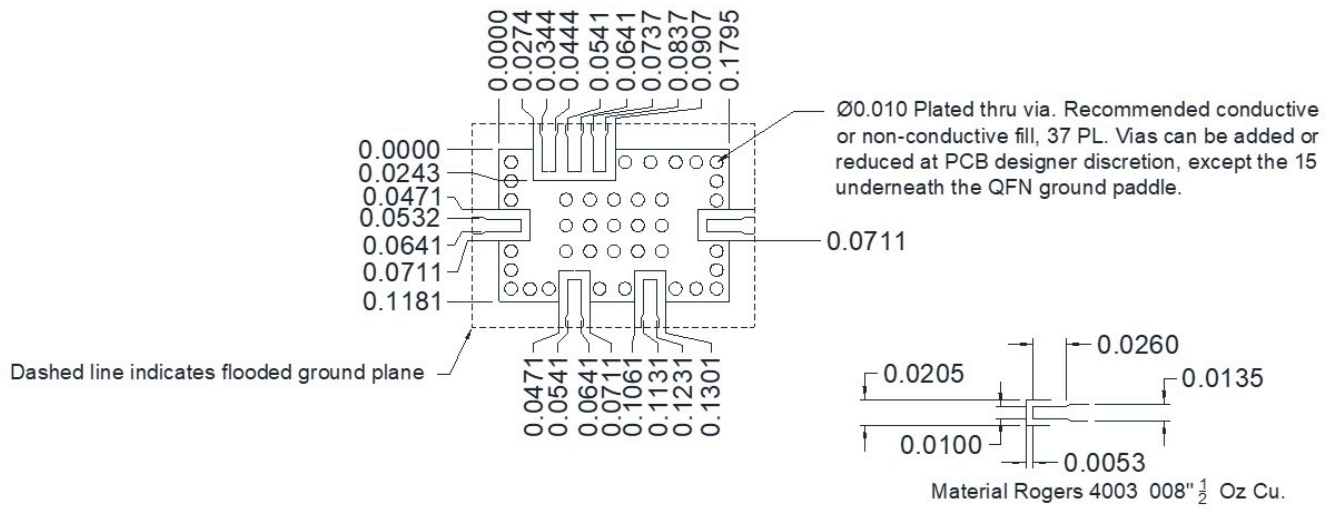

Evaluation Board - Outline Drawing

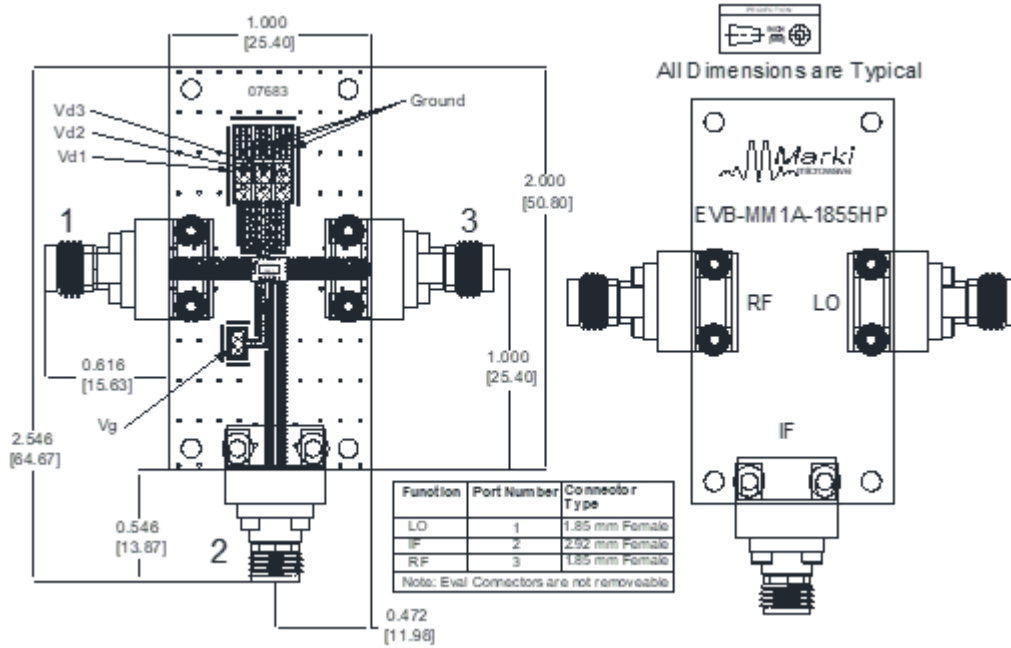

Evaluation Board - Application Circuit

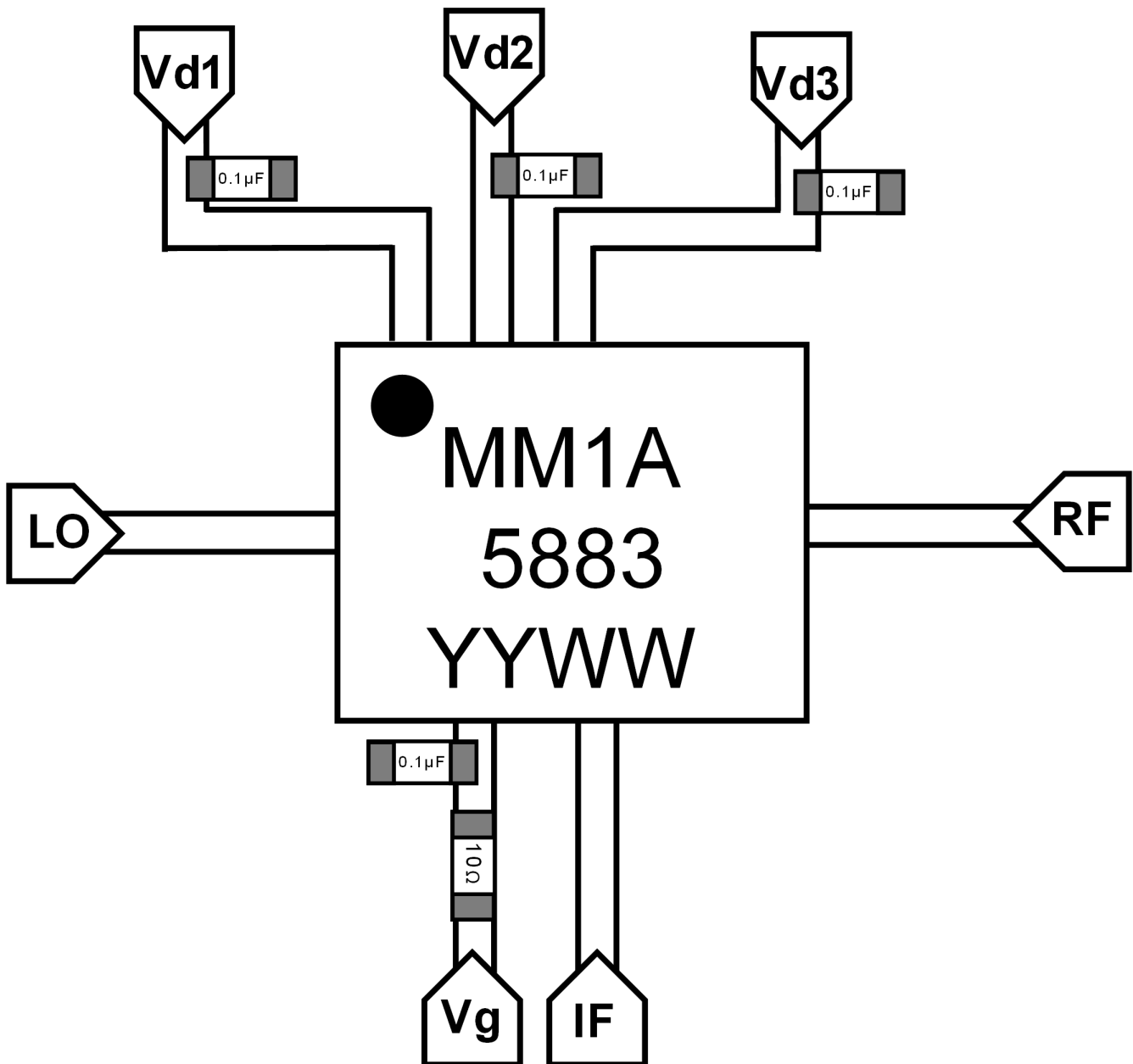

DISCLAIMER

MARKI MICROWAVE, LLC., ("MARKI") PROVIDES TECHNICAL SPECIFICATIONS AND DATA (INCLUDING DATASHEETS), APPLICATION OR OTHER DESIGN ADVICE, WEB TOOLS, AND OTHER INFORMATION AND RESOURCES "AS IS" AND WITH ALL FAULTS. MARKI DISCLAIMS ALL WARRANTIES, EXPRESS OR IMPLIED, INCLUDING, WITHOUT LIMITATION, ANY IMPLIED WARRANTIES OF MERCHANTABILITY, FITNESS FOR A PARTICULAR PURPOSE, OR NON-INFRINGEMENT.

These resources are intended for developers skilled in the art designing with Marki products. You are solely responsible for (1) selecting the appropriate products for your application, (2) designing, validating, and testing your application, and (3) ensuring your application meets applicable standards and other requirements. Marki makes no guarantee regarding the suitability of its products for any particular purpose, nor does Marki assume any liability whatsoever arising out of your use or application of any Marki product.

Marki grants you permission to use these resources only for development of an application that uses Marki products. Other reproduction or use of these resources is strictly prohibited. No license is granted to any other Marki intellectual property or to any third-party intellectual property. Marki reserves the right to make changes to the product(s) or information contained herein without notice.

MARKI MICROWAVE and T3 MIXER are trademarks or registered trademarks of Marki Microwave, LLC. All other trademarks used are the property of their respective owners.

© 2022, 2024, 2026, Marki Microwave, LLC