

ATN10-0040PSM

10dB DC-40GHz MMIC Attenuator

DEVICE OVERVIEW

General Description

The ATN10-0040PSM is a surface mount GaAs MMIC 10dB attenuator in a DFN package. This attenuator is an ideal solution for attenuating a signal and can be used in a wide range of applications. The compact DFN package allows for extreme miniaturization of SMT footprint making this attenuator suitable for low SWaP applications. GaAs MMIC technology provides consistent unit-to-unit performance in a small, low-cost form factor. A 50-ohm match is maintained over the entire operating frequency range.



[Download s-parameters here](#)

Features

- Small 1.3 x 2.0 mm package size
- 10dB attenuation from DC to 40 GHz
- 25dB typical return loss over operating band
- Low SWaP

Applications

- 5G
- Test Equipment
- Precision Characterization
- Airborne Applications
- Amplitude Matching
- High Channel Count Systems

Functional Block Diagram

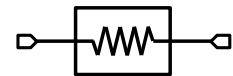

Part Ordering Options

Part Number	Description	Package	Green Status	Product Lifecycle	Export Classification
ATN10-0040PSM	10dB DC-40GHz MMIC Attenuator	DFN	RoHS REACH	Released	EAR99
EVB-ATN10-0040P	Evaluation Board, 10dB DC-40 GHz Attenuator	EVB	REACH RoHS	Released	EAR99

Table Of Contents

- **Device Overview**
 - General Description
 - Features
 - Applications
 - Functional Block Diagram
- **Port Configuration and Functions**
 - Port Diagram
 - Port Functions
- **Revision History**
- **Specifications**
 - Absolute Maximum Ratings
 - Package Information
 - Electrical Specifications
 - Typical Performance Plots
 - Electrical Performance Over Temperature
- **Mechanical Data**
 - Outline Drawing
- **Footprint Image**
- **Evaluation Board**
 - Evaluation Board Outline Drawing

Revision History

Revision Code	Revision Date	Comment
-	2023-10-30	Datasheet Initial Release
A	2026-03-02	ESD Class Added

Port Configuration and Functions

Port Diagram

A top-down x-ray view of the package outline drawing is shown below.

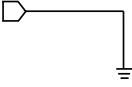
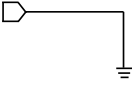
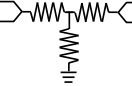
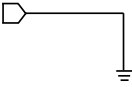
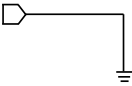
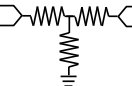
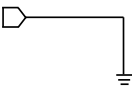

Port Functions

Port	Function	Description	DC Equivalent Circuit
GND	Ground	DFN package ground path is provided through the ground paddle.	
Pin 1	Non-connect (NC)	Pin 1 is not connected internally and can be tied to RF ground.	
Pin 2	Input/Output	Pin 2 and Pin 5 are DC connected to each other and ground through a T-network of resistors.	
Pin 3	Non-connect (NC)	Pin 3 is not connected internally and can be tied to RF ground.	
Pin 4	Non-connect (NC)	Pin 4 is not connected internally and can be tied to RF ground.	
Pin 5	Input/Output	Pin 2 and Pin 5 are DC connected to each other and ground through a T-network of resistors.	
Pin 6	Non-connect (NC)	Pin 6 is not connected internally and can be tied to RF ground.	

Specifications

Absolute Maximum Ratings

The Absolute Maximum Ratings indicate limits beyond which damage may occur to the device. If these limits are exceeded, the device may be inoperable or have a reduced lifetime.

Parameter	Maximum Rating	Unit
DC Current	100	mA
Maximum Operating Temperature	100	°C
Maximum Storage Temperature	125	°C
Minimum Operating Temperature	-55	°C
Minimum Storage Temperature	-65	°C
RF Power Handling	2	W

Package Information

Parameter	Details	Rating
ESD	1000 to < 2000 Volts	HBM Class 1C
Dimensions	-	2.0 x 1.3 mm
Moisture Sensitivity Level	-	MSL 1

Electrical Specifications

The electrical specifications apply at TA=+25°C in a 50Ω system. Typical data shown is for the attenuator in a PSM package with a sine wave input applied to pin 2.

Parameter	Test Conditions	Minimum Frequency (GHz)	Maximum Frequency (GHz)	Min	Typ	Max	Unit
Attenuation	-	0	40	-	10	-	dB
Attenuation Flatness	-	0	40	-	0.4	-	dB
Impedance	-	0	40	-	50	-	Ω
Return Loss	-	0	40	15	25	-	dB

Typical Performance Plots

Measured data is de-embedded from evaluation fixture using AFR.

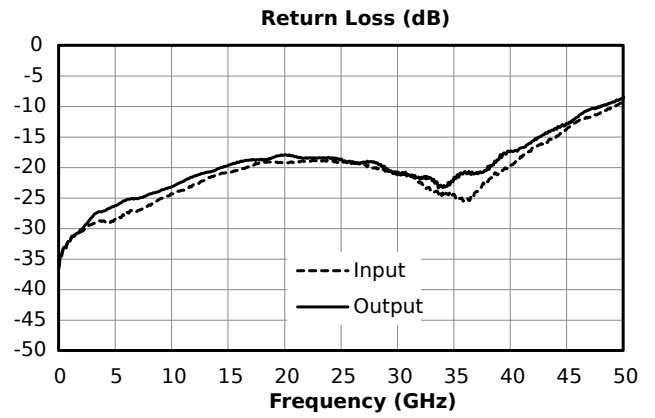
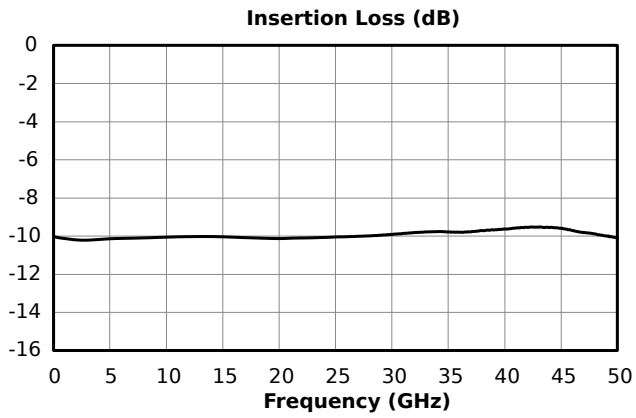

Electrical Performance Over Temperature

Evaluation board performance is shown as a proxy for device performance due to fixturing variability over temperature

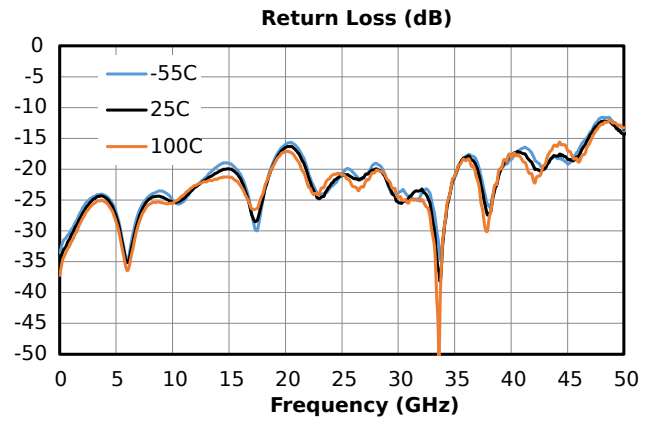
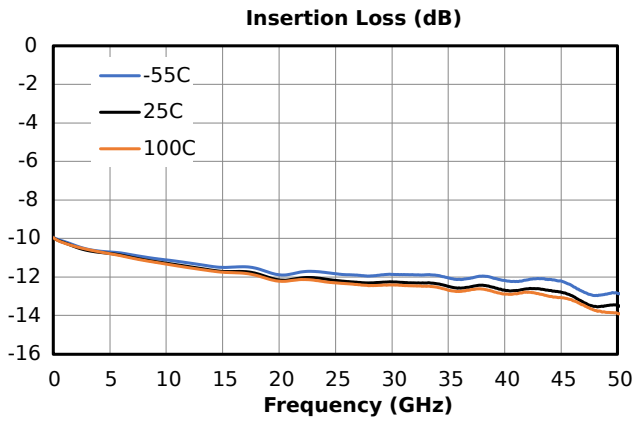

Mechanical Data

Outline Drawing

Download : [Outline 2D Drawing](#) | [Outline 3D Drawing](#) | [Outline 3D STP](#)

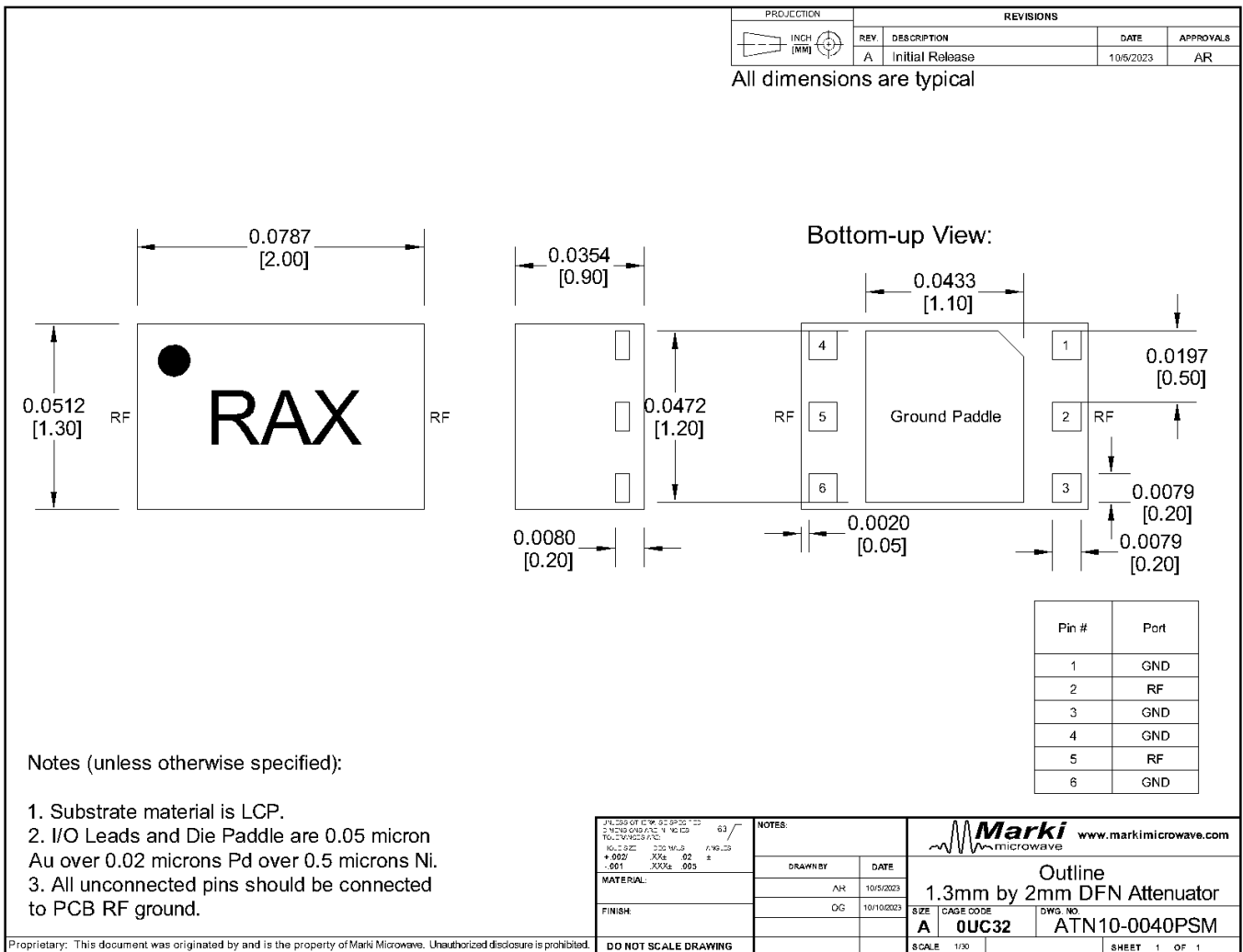

Evaluation Board - Outline Drawing

All measurements are typical

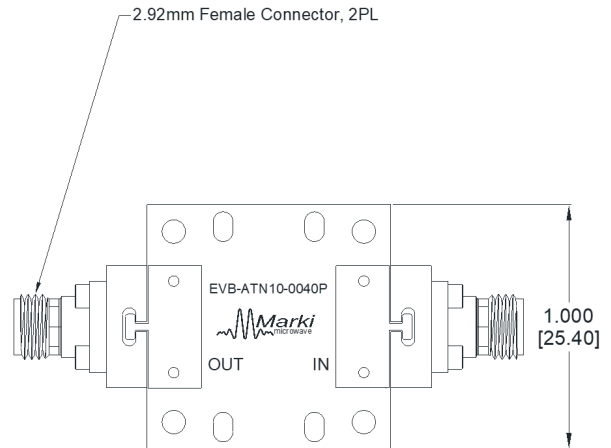
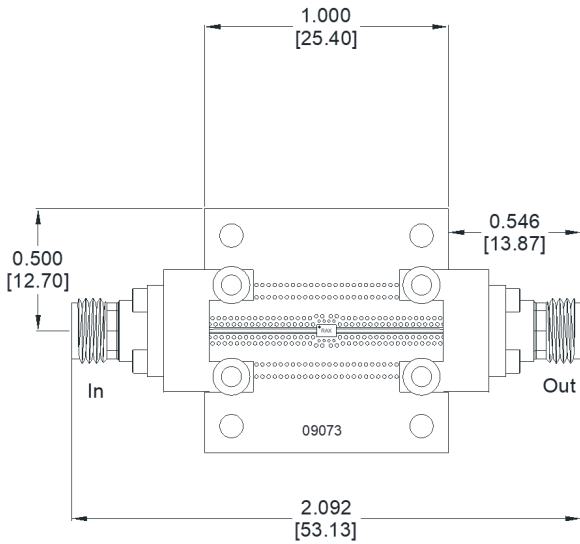
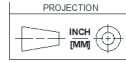

DISCLAIMER

MARKI MICROWAVE, LLC., ("MARKI") PROVIDES TECHNICAL SPECIFICATIONS AND DATA (INCLUDING DATASHEETS), APPLICATION OR OTHER DESIGN ADVICE, WEB TOOLS, AND OTHER INFORMATION AND RESOURCES "AS IS" AND WITH ALL FAULTS. MARKI DISCLAIMS ALL WARRANTIES, EXPRESS OR IMPLIED, INCLUDING, WITHOUT LIMITATION, ANY IMPLIED WARRANTIES OF MERCHANTABILITY, FITNESS FOR A PARTICULAR PURPOSE, OR NON-INFRINGEMENT.

These resources are intended for developers skilled in the art designing with Marki products. You are solely responsible for (1) selecting the appropriate products for your application, (2) designing, validating, and testing your application, and (3) ensuring your application meets applicable standards and other requirements. Marki makes no guarantee regarding the suitability of its products for any particular purpose, nor does Marki assume any liability whatsoever arising out of your use or application of any Marki product.

Marki grants you permission to use these resources only for development of an application that uses Marki products. Other reproduction or use of these resources is strictly prohibited. No license is granted to any other Marki intellectual property or to any third-party intellectual property. Marki reserves the right to make changes to the product(s) or information contained herein without notice.

MARKI MICROWAVE and T3 MIXER are trademarks or registered trademarks of Marki Microwave, LLC. All other trademarks used are the property of their respective owners.

© 2023, 2026, Marki Microwave, LLC