

MQS-0418CH

MMIC 4-18GHz 90° Splitter / Combiner

DEVICE OVERVIEW

General Description

The MQS-0418 is a MMIC 4GHz – 18GHz 90° splitter/combiner. Wire bondable 50Ω terminations are available on-chip. Passive GaAs MMIC technology allows production of smaller constructions that replace larger form factor circuit board constructions. Tight fabrication tolerances allow for less unit to unit variation than traditional splitter/combiner technologies. The MQS-0418 is available as a wire bondable chip and connectorized module. Low variation allows for accurate simulations using the provided S4P file taken from measured production units. The MQS-0418 is not recommended for applications involving reflected signals.

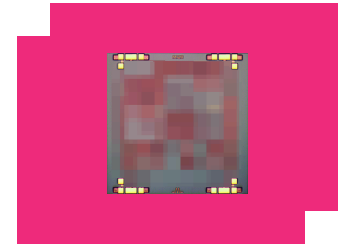

Features

- Designed for C to Ku-band applications
- High amplitude and phase balance
- High isolation
- Low insertion loss
- On-chip 50Ω load terminations

Applications

- Single Sideband Upconverters
- Image Rejection Downconverters
- IQ Modulators
- Balanced Amplifiers
- Microwave Correlators

Functional Block Diagram

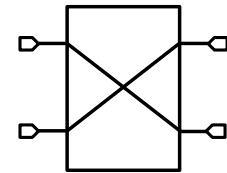

Part Ordering Options

Part Number	Description	Package	Connectors	Green Status	Product Lifecycle	Export Classification
MQS-0418UA	MMIC 4-18GHz 90° Splitter / Combiner	UA	Standard	REACH RoHS	Released	EAR99
MQS-0418CH	MMIC 4-18GHz 90° Splitter / Combiner	CH	-	REACH RoHS	Released	EAR99

Table Of Contents

- **Device Overview**
 - General Description
 - Features
 - Applications
 - Functional Block Diagram
- **Port Configuration and Functions**
 - Port Diagram
 - Port Functions
- **Revision History**
- **Specifications**
 - Absolute Maximum Ratings
 - Package Information
 - Electrical Specifications
 - Typical Performance Plots
 - MQS-0418UA Typical Performance Plots
- **Die Mounting Recommendations**
 - Mounting and Bounding Recommendations
- **Operation**
 - Application Circuit Description
- **Mechanical Data**
 - Outline Drawing

Revision History

Revision Code	Revision Date	Comment
-	2018-08-01	Datasheet Initial Release

Port Configuration and Functions

Port Diagram

A top-down view of the MQS-0418CH package outline drawing is shown below. Only ports 1 and 2 may be used as an input. Ports 3 and 4 are not recommended as inputs. Device is not recommended for applications requiring reflected signals. Ports 1 – 4 correspond to the UA package designation.

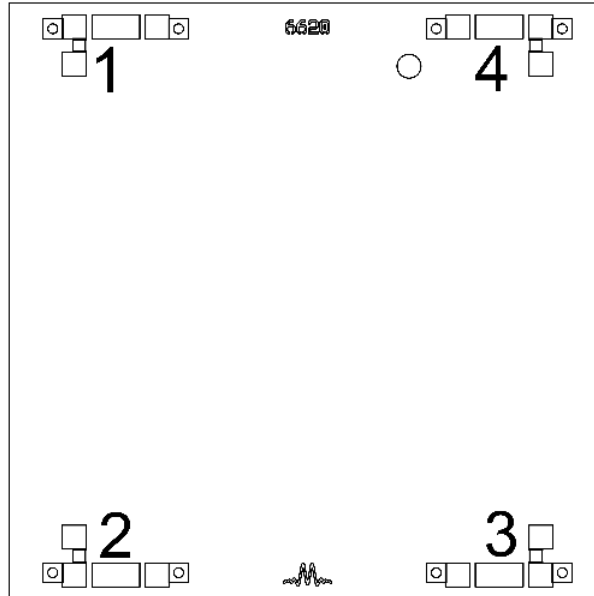

Port Functions

Configuration A

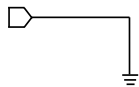
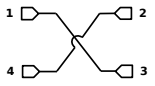
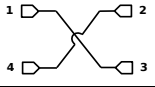
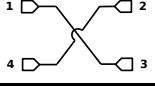
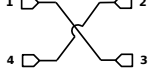
Port	Function	Description	Equivalent Circuit for Package
Pad	Ground	CH package ground path is provided through the substrate and ground bond pads.	
Port 1	Input	Port 1 is DC short to port 3 and open to ground.	
Port 2	90° Output	Port 2 is DC short to port 4 and open to ground.	
Port 3	0° Output	Port 3 is DC short to port 1 and open to ground.	
Port 4	Isolated	Port 4 is DC short to port 2 and open to ground.	

Configuration B

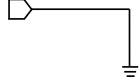
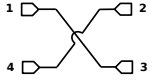
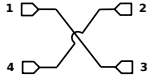
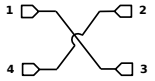
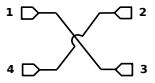
Port	Function	Description	Equivalent Circuit for Package
Pad	Ground	CH package ground path is provided through the substrate and ground bond pads.	
Port 1	90° Output	Port 1 is DC short to port 3 and open to ground.	
Port 2	Input	Port 2 is DC short to port 4 and open to ground.	
Port 3	Isolated	Port 3 is DC short to port 1 and open to ground.	
Port 4	0° Output	Port 4 is DC short to port 2 and open to ground.	

Specifications

Absolute Maximum Ratings

The Absolute Maximum Ratings indicate limits beyond which damage may occur to the device. If these limits are exceeded, the device may be inoperable or have a reduced lifetime.

Parameter	Maximum Rating	Unit
Maximum Storage Temperature	125	°C
Minimum Operating Temperature	-55	°C
Minimum Operating Temperature	100	°C
Minimum Storage Temperature	-65	°C

Package Information

Parameter	Details	Rating
Dimensions	-	2.50 x 2.50 mm

Electrical Specifications

The electrical specifications apply at TA=+25°C in a 50Ω system. Min and Max limits are guaranteed at TA=+25°C. Device is non-reciprocal. Operation not guaranteed when ports 3 or 4 are used as an input.

Parameter	Port Configuration	Test Conditions	Minimum Frequency (GHz)	Maximum Frequency (GHz)	Min	Typ	Max	Unit
Amplitude Balance	-	-	4	18	-	0.4	2	dB
Excess Through Line Insertion Loss	-	-	4	18	-	1.5	3.2	dB
Impedance	-	-	4	18	-	50	-	Ω
Isolation	-	-	4	18	11	16	-	dB
Mean Coupling	-	-	4	18	-	3	-	dB
Nominal Phase Shift	-	-	4	18	-	90	-	°
Phase Balance	-	-	4	18	-	0.5	8	°
VSWR	-	-	4	18	-	1.1	-	

Typical Performance Plots

All measurements taken in a 50Ω environment. On-chip load was not used when taking measurements.

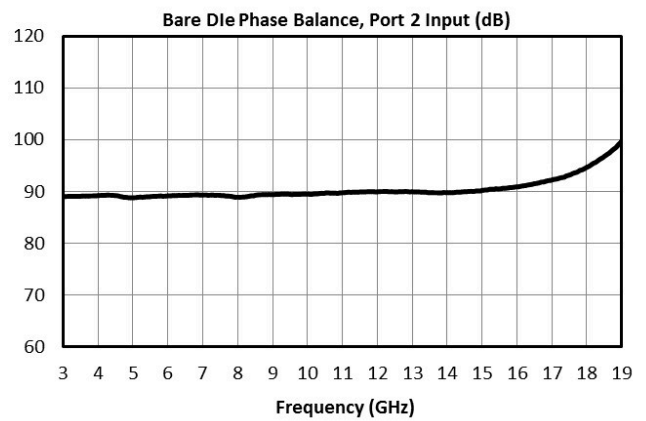
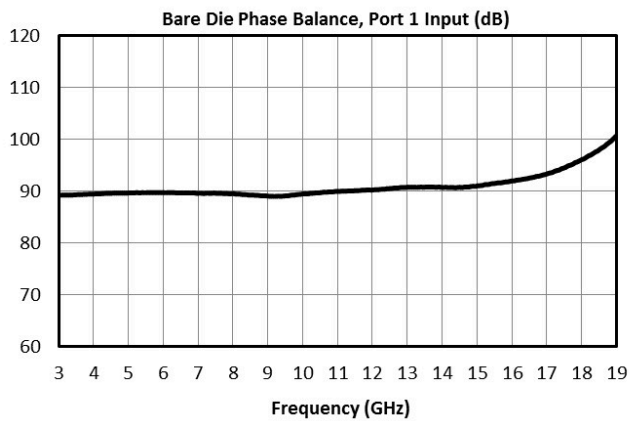
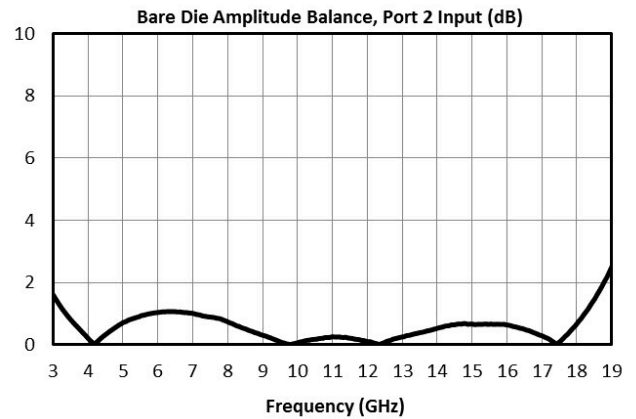
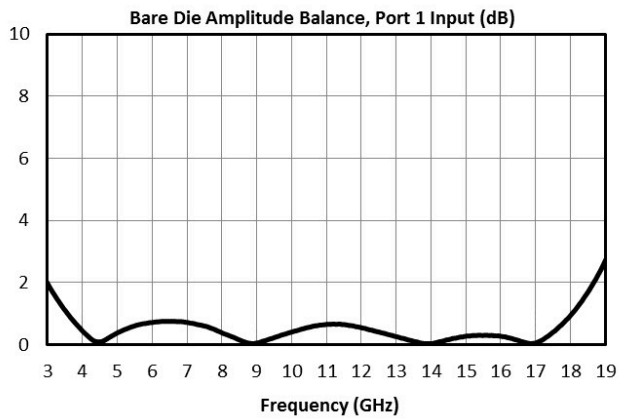
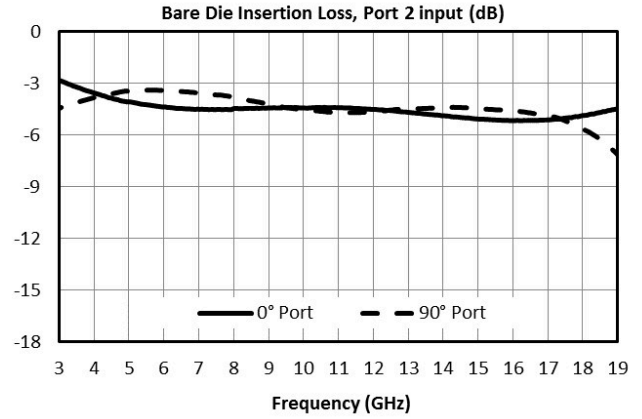
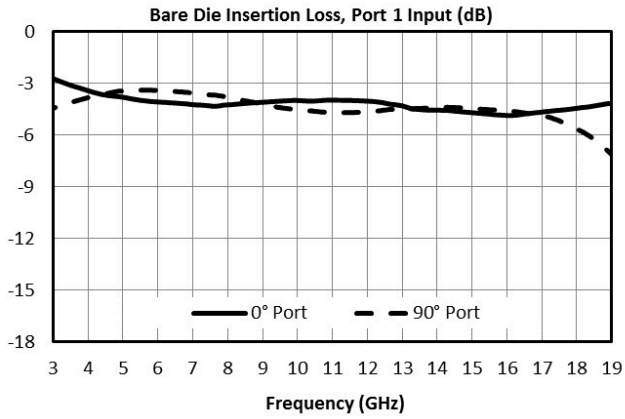

MQS-0418CH

MMIC 4-18GHz 90° Splitter / Combiner

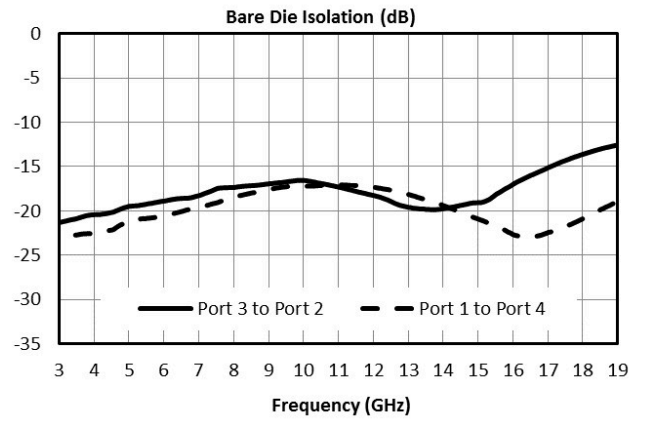
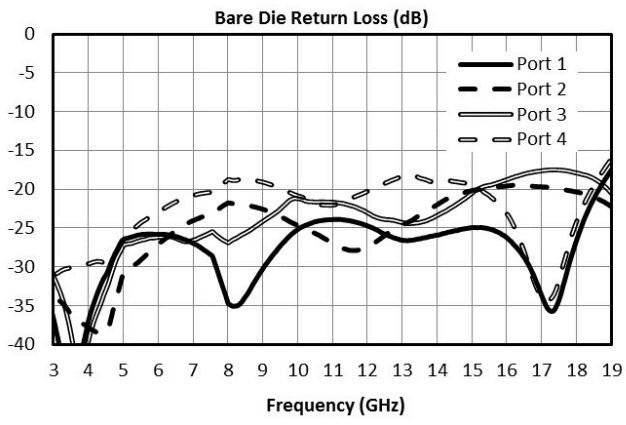

MQS-0418UA - Typical Performance Plots

Phase balance spread is shown due to large performance spread. Minimal variance observed in amplitude balance and insertion loss. Performance spread is related to packaging and bond wire inductance variation.

Performance plots for the connectorized module are shown for measurements where directly probed measurements of the die are unavailable. Note that the following measurements include losses from connectors and microstrip traces.

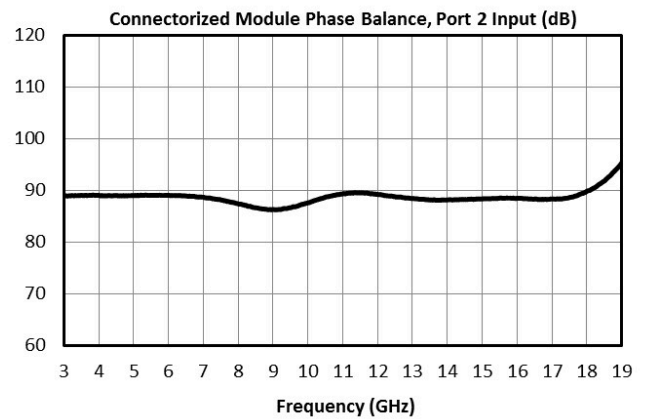
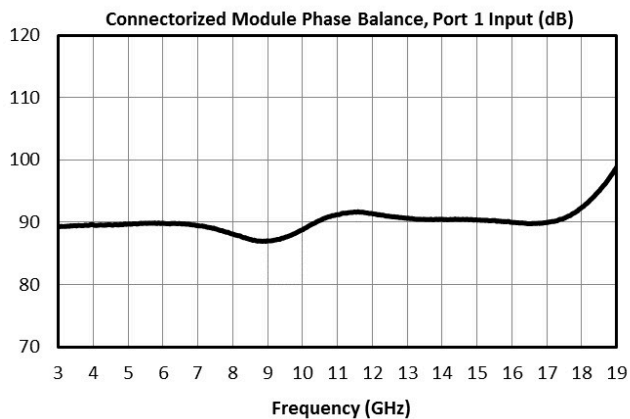
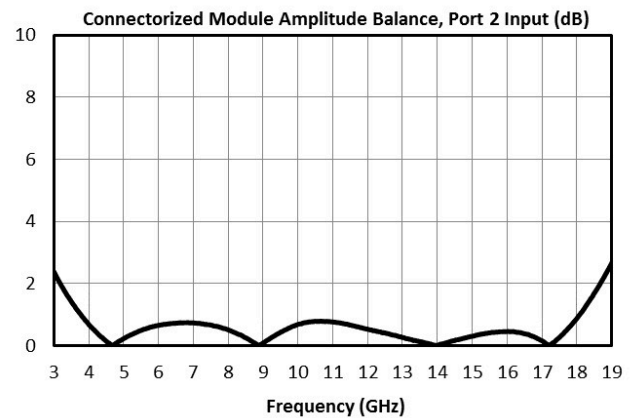
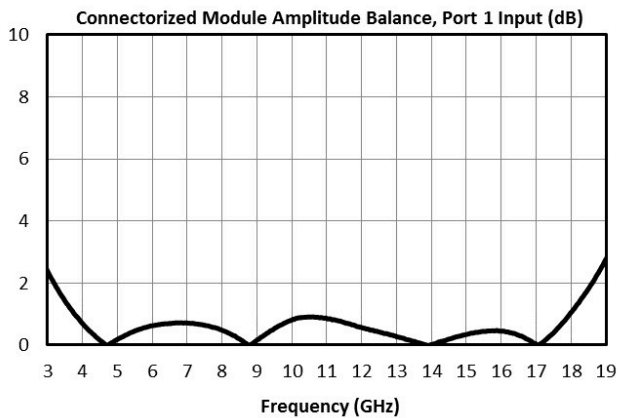
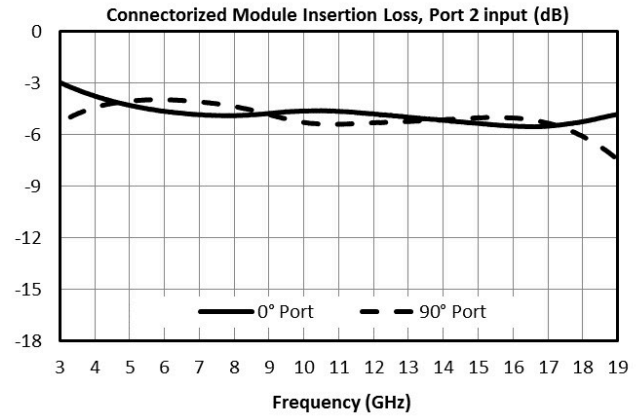
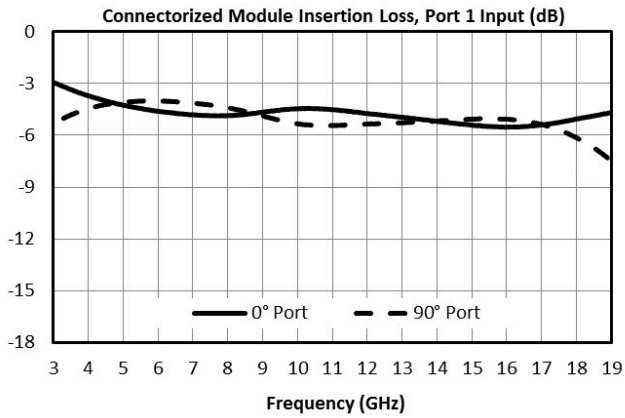

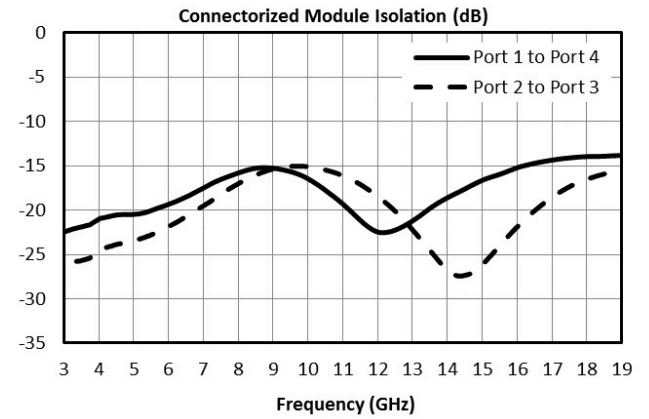
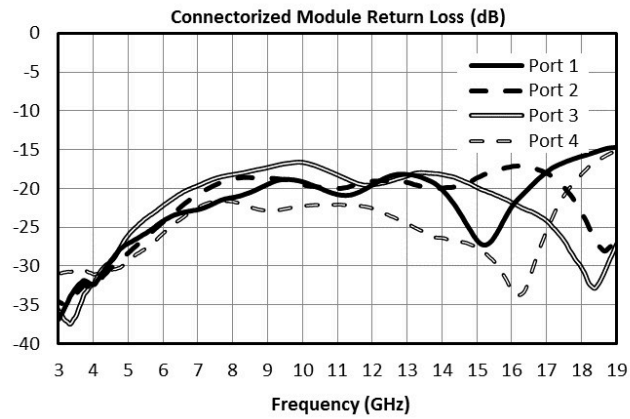
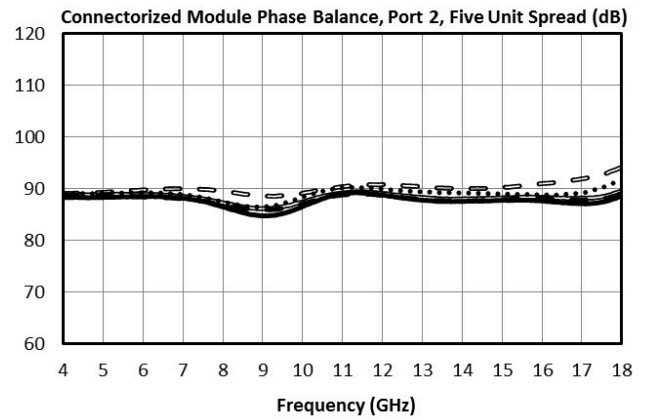
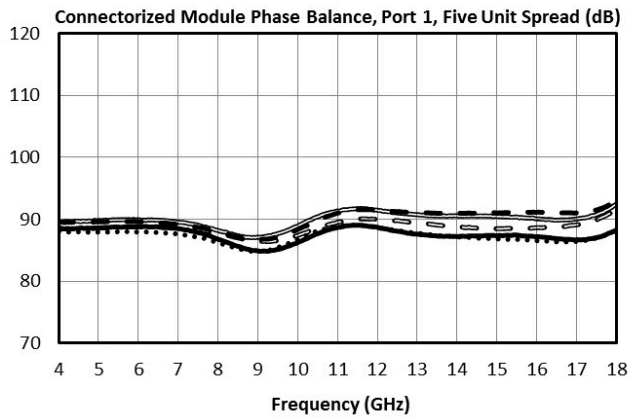

Application Circuit Description

Quadrature signal generation is useful for many applications in analog signal processing. Marki MQH/S MMIC quadrature hybrids and 90° Splitter/Combiners offer this functionality in a small factor with high repeatability. Below are applications and how they can be realized with the MQH and MQS product lines.

Quadrature Hybrids vs 90° Splitter/Combiners

Some products are 'true' quadrature hybrids, while others are 90° Splitter/Combiners. A quadrature hybrid is symmetric about all four ports, meaning that in a splitting application any port can be used as an input, with the isolated and output ports following from this selection. Likewise, for a combining application, any port can be used as an output.

A 90° Splitter/Combiner is not symmetric. When splitting, only ports 1 and 2 can be used as an input. If ports 3 or 4 were used, there would be significant phase walk-off between the output ports. As a combiner, only ports 1 and 2 are suitable as output ports. The phase walk-off introduced when using ports 3 or 4 as an output means that reflected signals recombine and cancel poorly inside a 90° Splitter/Combiner.

Single Sideband and Image Reject Mixers

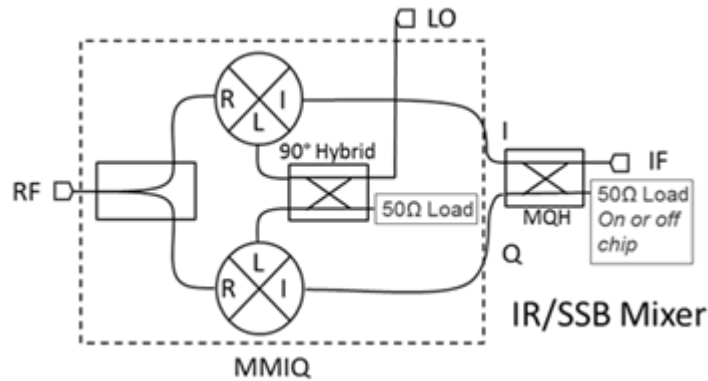

The primary application for the MQH and MQS series is as IF or LO quadrature signal splitter/combiners. They can be used in combination with the MMIQ series of IQ mixers to create broadband single sideband and image reject mixers. Either 90° Splitter/Combiners or quadrature hybrids can be used as the IF hybrid, but if a 90° Splitter/Combiner is used only one sideband (or image) is accessible, whereas if a quadrature hybrid is used then both sidebands are accessible.

If 90° Splitter/Combiner is used for a single sideband upconverter or image reject mixer, port 1 (or 2) should be used as the IF input/output and ports 2 and 3 (or 1 and 4) should be connected to the I and Q ports. Selecting port 1 or 2 to terminate will select which sideband of the mixer to reject.

Balanced Amplifiers

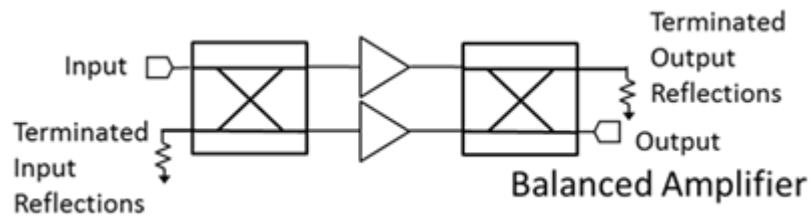

In a balanced amplifier, the poor return loss of an amplifier is compensated for with a quadrature hybrid. In this application, the reflections from the input or output are collected at the isolated port of the quadrature hybrid and terminated.

Since a 90° Splitter/Combiner is not completely symmetric, reflected signals will not terminate as well as with a quadrature hybrid. An MQH option is recommended for this application. If a 90° Splitter/Combiner is used for a single sideband upconverter or image reject mixer, port 1 (or 2) should be used as the IF input/output and ports 2 and 3 (or 1 and 4) should be connected to the I and Q ports. Selecting port 1 or 2 to terminate will select which sideband of the mixer to reject. Testing/simulation is recommended when considering if a 90° Splitter/Combiner is suitable.

Reflectionless Filter

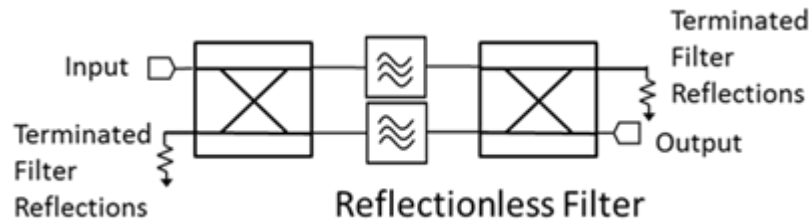

Similar to a balanced amplifier, a reflectionless filter will terminate reflections that are out of band for a filter (but in band for the quadrature hybrid) at the isolated port.

Since a 90° Splitter/Combiner is not completely symmetric, reflected signals will not terminate as well as with a quadrature hybrid. An MQH option is recommended for this application. If a 90° Splitter/Combiner is used for a single sideband upconverter or image reject mixer, port 1 (or 2) should be used as the IF input/output and ports 2 and 3 (or 1 and 4) should be connected to the I and Q ports. Selecting port 1 or 2 to terminate will select which sideband of the mixer to reject. Testing/simulation is recommended when considering if a 90° Splitter/Combiner is suitable.

Reflective Applications

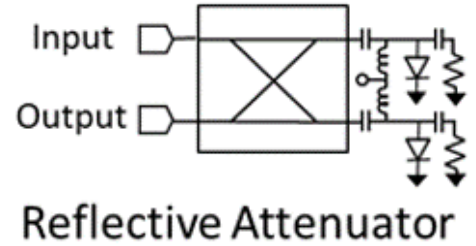
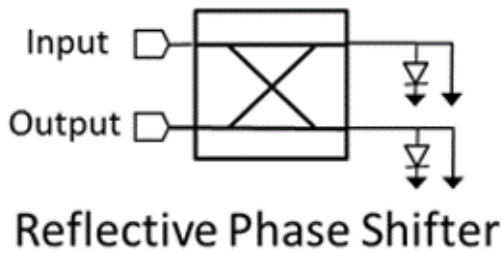

Unlike in the previous applications, reflective applications only work well with a quadrature hybrid (not a 90° Splitter/Combiner). In these applications a signal is reflected off of two identical structures (typically a PIN diode) and the output signal is collected at the isolated port. In this case the desired signal is deliberately reflected.

Since a 90° Splitter/Combiner is not completely symmetric, you will have poor results if you use these for reflective applications.

Die Mounting Recommendations

Mounting and Bonding Recommendations

Marki MMICs should be attached directly to a ground plane with conductive epoxy. The ground plane electrical impedance should be as low as practically possible. This will prevent resonances and permit the best possible electrical performance. Datasheet performance is only guaranteed in an environment with a low electrical impedance ground.

Mounting - To epoxy the chip, apply a minimum amount of conductive epoxy to the mounting surface so that a thin epoxy fillet is observed around the perimeter of the chip. Cure epoxy according to manufacturer instructions.

Wire Bonding - Ball or wedge bond with 0.025 mm (1 mil) diameter pure gold wire. Thermosonic wirebonding with a nominal stage temperature of 150 °C and a ball bonding force of 40 to 50 grams or wedge bonding force of 18 to 22 grams is recommended. Use the minimum level of ultrasonic energy to achieve reliable wirebonds. Wirebonds should be started on the chip and terminated on the package or substrate.

Circuit Considerations – 50 Ω transmission lines should be used for all high frequency connections in and out of the chip. In circumstances where the chip more than .001" thinner than the substrate, a heat spreading spacer tab is optional to further reduce bondwire length and parasitic inductance.

Special Considerations for 90° Splitters – Transitions between the chip and transmission line should be as close to 50 Ω as possible. Small impedance mismatches will result in poor phase balance mid-band due to reflections. Length and number of wire bonds should be adjusted to tune inductance for an optimal 50 Ω match. In the modules, chip transitions are optimized for broadband performance.

Handling Precautions

General Handling

Chips should be handled with care using tweezers or a vacuum collet. Users should take precautions to protect chips from direct human contact that can deposit contaminants, like perspiration and skin oils on any of the chip's surfaces.

Cleaning and Storage: Do not attempt to clean the chip with a liquid cleaning system or expose the bare chips to liquid. Once the ESD sensitive bags the chips are stored in are opened, chips should be stored in a dry nitrogen atmosphere.

Bonding Diagram

The MQS-0418 has 50Ω loads near each I/O port, allowing the user to terminate the isolated port on-chip.

Four Port Device

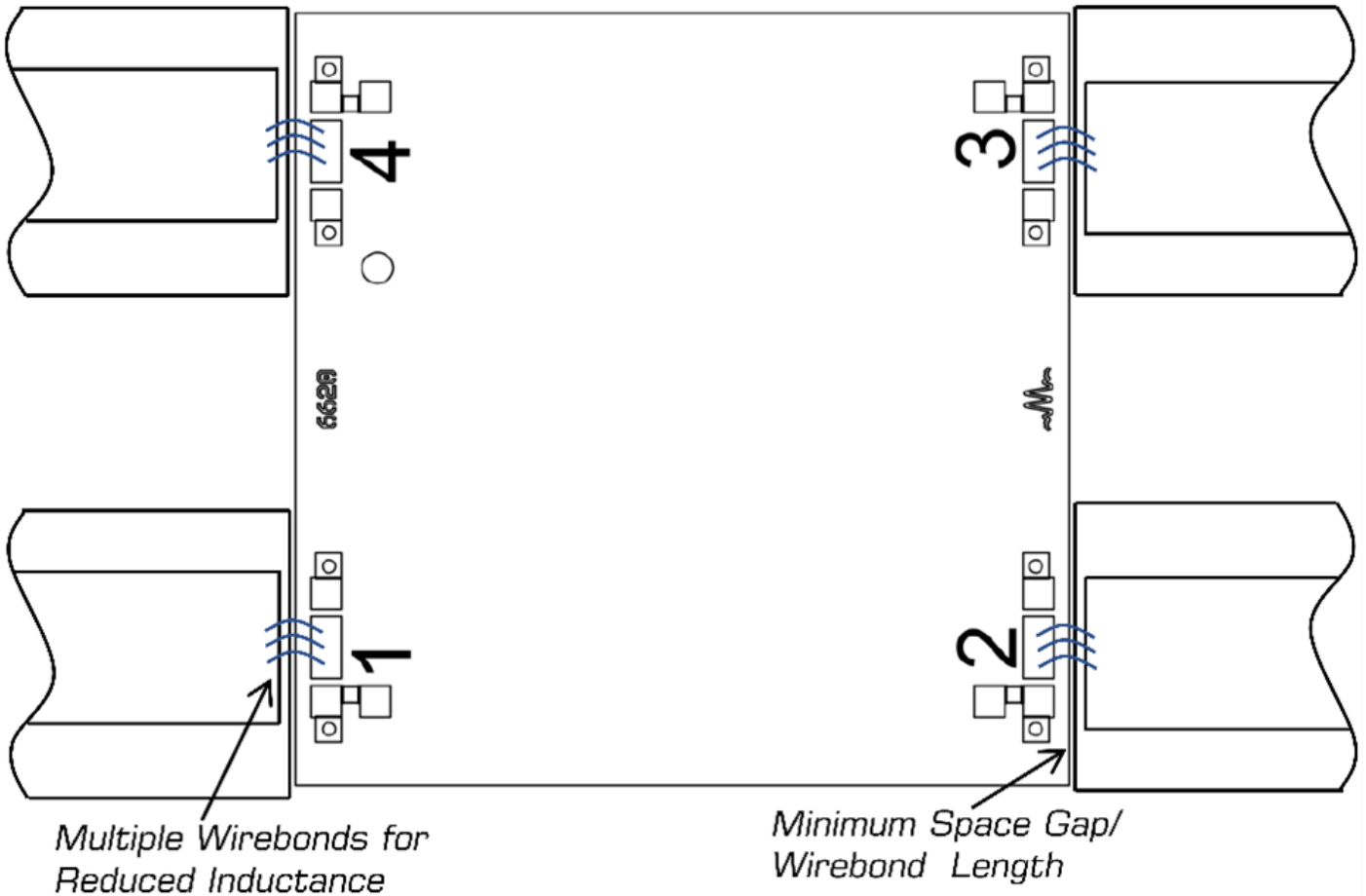

Isolated Port Terminated

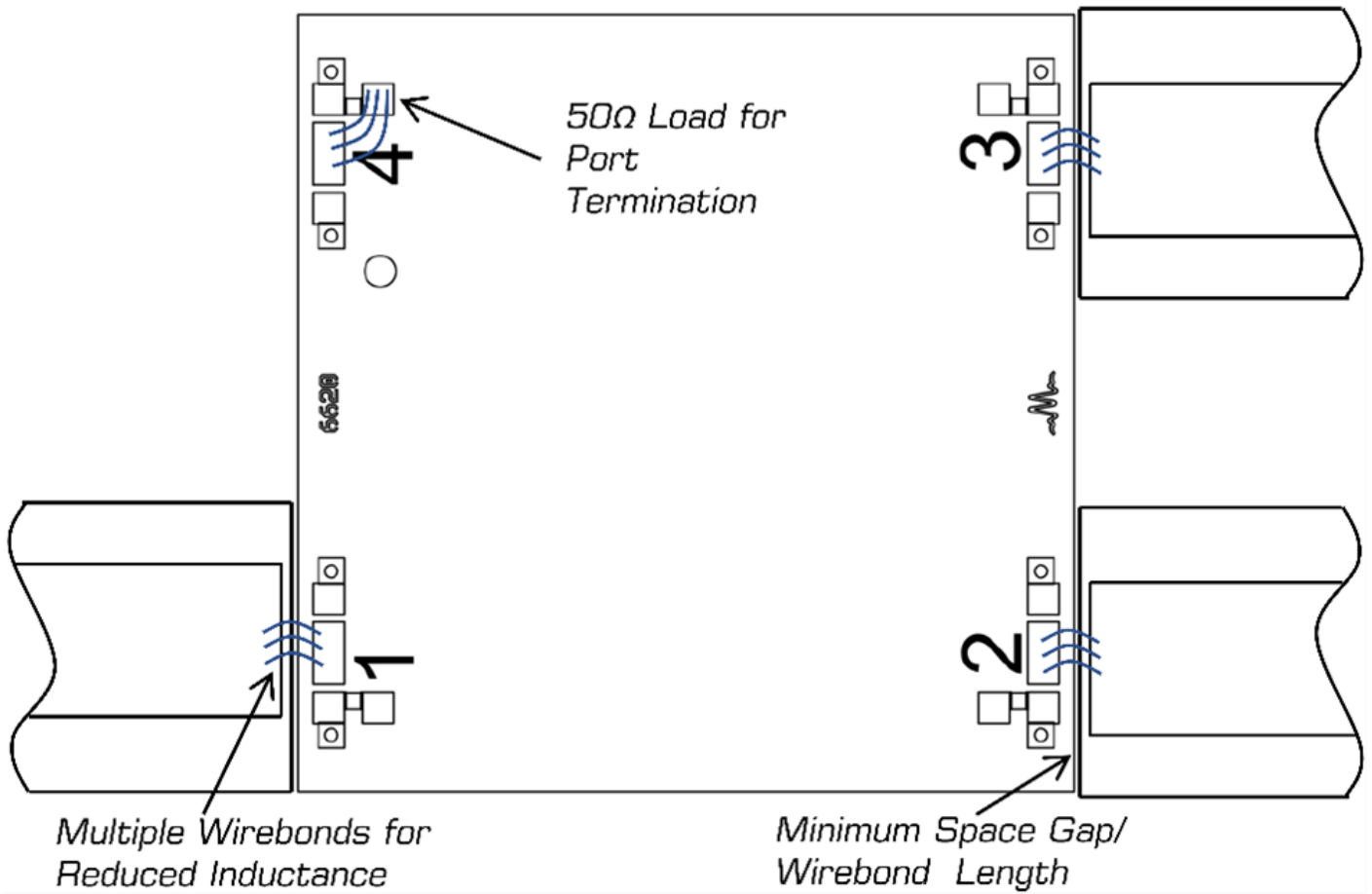

Mechanical Data

Outline Drawing

Download : [Outline 2D Drawing](#)

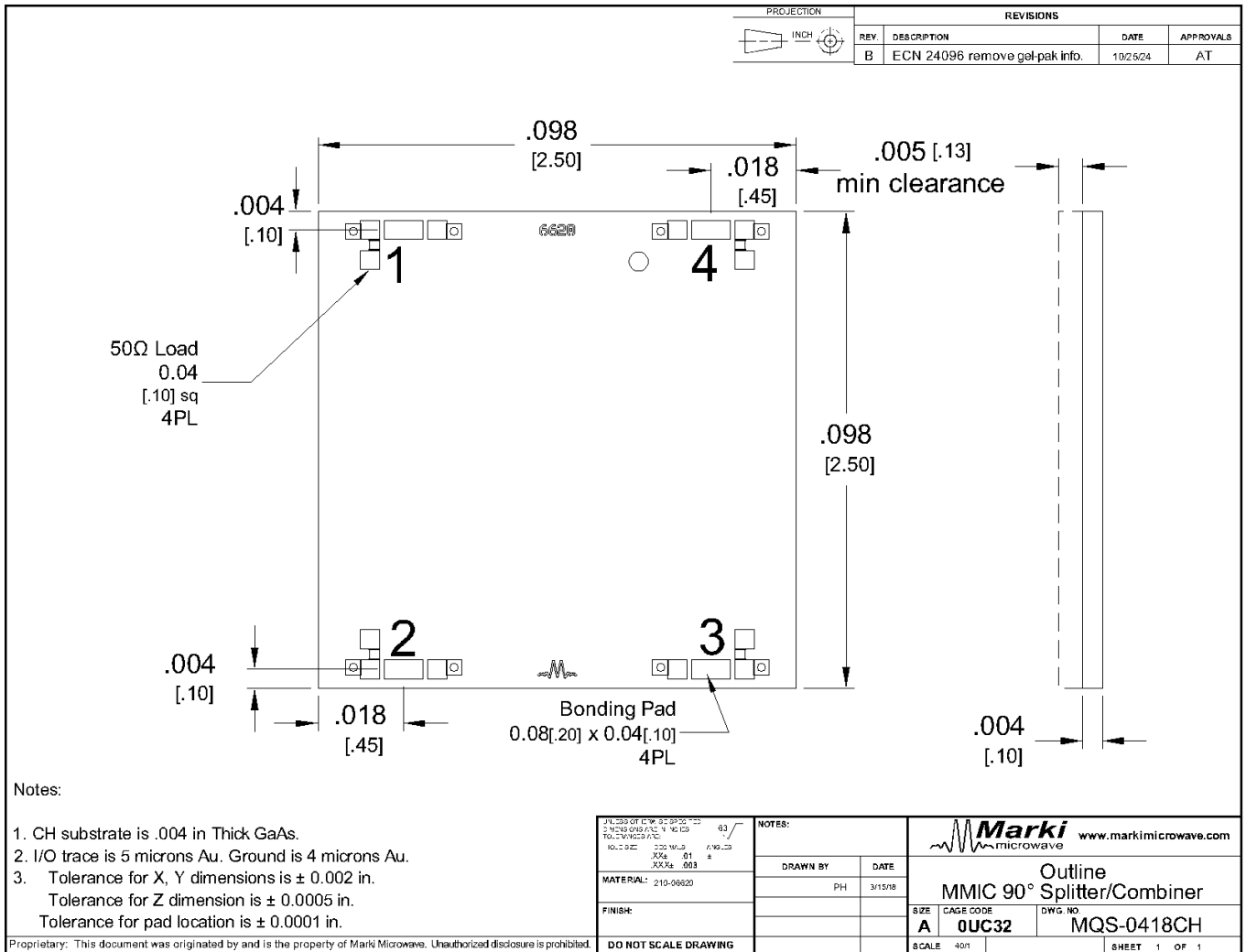

DISCLAIMER

MARKI MICROWAVE, INC., ("MARKI") PROVIDES TECHNICAL SPECIFICATIONS AND DATA (INCLUDING DATASHEETS), APPLICATION OR OTHER DESIGN ADVICE, WEB TOOLS, AND OTHER INFORMATION AND RESOURCES "AS IS" AND WITH ALL FAULTS. MARKI DISCLAIMS ALL WARRANTIES, EXPRESS OR IMPLIED, INCLUDING, WITHOUT LIMITATION, ANY IMPLIED WARRANTIES OF MERCHANTABILITY, FITNESS FOR A PARTICULAR PURPOSE, OR NON-INFRINGEMENT.

These resources are intended for developers skilled in the art designing with Marki products. You are solely responsible for (1) selecting the appropriate products for your application, (2) designing, validating, and testing your application, and (3) ensuring your application meets applicable standards and other requirements. Marki makes no guarantee regarding the suitability of its products for any particular purpose, nor does Marki assume any liability whatsoever arising out of your use or application of any Marki product.

Marki grants you permission to use these resources only for development of an application that uses Marki products. Other reproduction or use of these resources is strictly prohibited. No license is granted to any other Marki intellectual property or to any third-party intellectual property. Marki reserves the right to make changes to the product(s) or information contained herein without notice.

MARKI MICROWAVE and T3 MIXER are trademarks or registered trademarks of Marki Microwave, Inc. All other trademarks used are the property of their respective owners.

© 2018, Marki Microwave, Inc