

MM1-0212HSM-2

GaAs MMIC Double Balanced Mixer

DEVICE OVERVIEW

General Description

The MM1-0212HSM is a GaAs MMIC double balanced mixer that is optimized for low frequency applications. MM1-0212HSM is a low frequency S band mixer that works well as both an up and down converter through X band. This mixer offers low conversion loss and high LO to RF isolations at moderate LO powers. The sister MM1-0212SSM is recommended for applications which demand higher linearity. The MM1-0212LSM is recommend for low power applications. The MM1-0212HSM is available in a 4x4 mm QFN package. Evaluation boards are available.

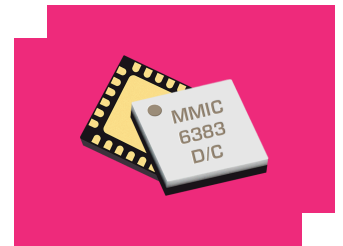

Features

- High LO to RF isolation
- RoHS Compliant

Applications

- Test and Measurement Equipment

Functional Block Diagram

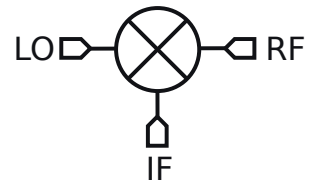

Part Ordering Options

Part Number	Description	Package	Packing Size	Green Status	Product Lifecycle	Export Classification
MM1-0212HSM-2	GaAs MMIC Double Balanced Mixer	QFN	-	REACH RoHS	Released	EAR99
EVAL-MM1-0212H	Evaluation Board, GaAs MMIC Double Balanced Mixer	EVAL	-	REACH RoHS	Released	EAR99
MM1-0212H-2-TR	Tape and Reel, GaAs MMIC Double Balanced Mixer	QFN	7"	REACH RoHS	Released	EAR99

Table Of Contents

- **Device Overview**
 - General Description
 - Features
 - Applications
 - Functional Block Diagram
- **Port Configuration and Functions**
 - Port Diagram
 - Port Functions
- **Revision History**
- **Specifications**
 - Absolute Maximum Ratings
 - Package Information
 - Recommended Operating Conditions
 - Sequencing Requirements
 - Electrical Specifications
 - Typical Performance Plots
 - Typical Performance Plots: IP3
 - Typical Performance Plots: LO Harmonic Isolation
 - Spur Tables
- **Operation**
 - Application Circuit
 - Application Circuit Description
- **Mechanical Data**
 - Outline Drawing
- **Footprint Image**
- **Evaluation Board**
 - Evaluation Board Outline Drawing

Revision History

Revision Code	Revision Date	Comment
-	2018-07-01	Datasheet Initial Release
A	2018-11-01	Package Outline Drawing, Note 2
B	2019-01-01	Added max power/current spec, ESD rating

Port Configuration and Functions

Port Diagram

A bottom-up view of the MM1-0212HSM's SM package outline drawing is shown below. The MM1-0212HSM has the input and output ports given in Port Functions. The MM1-0212HSM can be used in either an up or down conversion. For configuration A, input the LO into pin 3, use pin 16 for the RF, and port 9 for the IF. For configuration B, input the LO into pin 16, use pin 3 for the RF, and pin 9 for the IF.

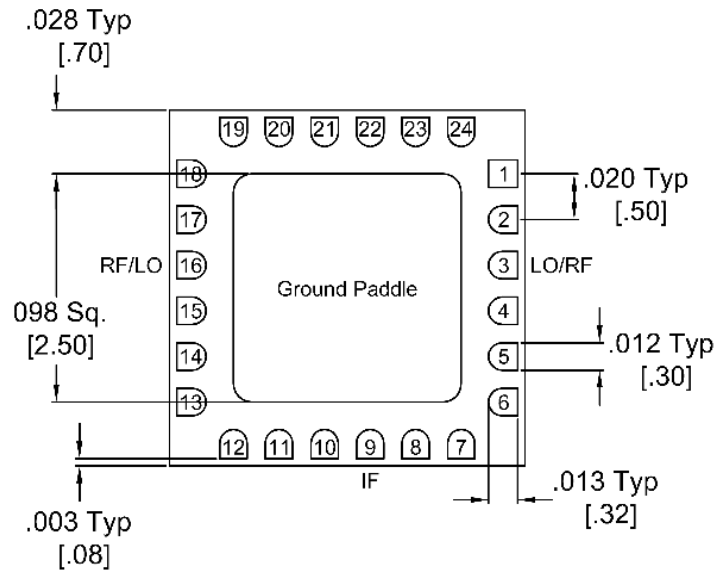

Port Functions

Configuration A

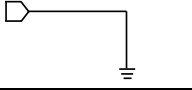
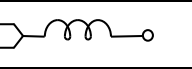
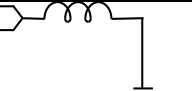
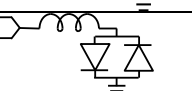
Port	Function	Description	Equivalent Circuit for Package
GND	Ground	SM package ground path is provided through the ground paddle.	
Pin 16	RF	Pin 16 is DC open and AC matched to 50 Ohms from 2 to 12 GHz. Blocking capacitor is optional.	
Pin 3	LO	Pin 3 is DC short and AC matched to 50 Ohms from 2 to 12 GHz. Blocking capacitor is optional.	
Pin 9	IF	Pin 9 is DC coupled to the diodes. Blocking capacitor is optional.	

Configuration B

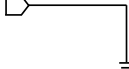
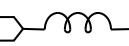
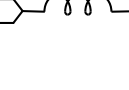
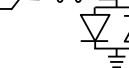
Port	Function	Description	Equivalent Circuit for Package
GND	Ground	SM package ground path is provided through the ground paddle.	
Pin 16	LO	Pin 16 is DC open and AC matched to 50 Ohms from 2 to 12 GHz. Blocking capacitor is optional.	
Pin 3	RF	Pin 3 is DC short and AC matched to 50 Ohms from 2 to 12 GHz. Blocking capacitor is optional.	
Pin 9	IF	Pin 9 is DC coupled to the diodes. Blocking capacitor is optional.	

Specifications

Absolute Maximum Ratings

The Absolute Maximum Ratings indicate limits beyond which damage may occur to the device. If these limits are exceeded, the device may be inoperable or have a reduced lifetime.

Parameter	Maximum Rating	Unit
Maximum Operating Temperature	100	°C
Maximum Storage Temperature	125	°C
Minimum Operating Temperature	-55	°C
Minimum Storage Temperature	-65	°C
Pin 3 DC Current	30	mA
Pin 9 DC Current	30	mA
Power Handling, at any Port	30	dBm

Package Information

Parameter	Details	Rating
ESD	250 to < 500 Volts	HBM Class 1A
Dimensions	-	4 x 4 mm
Moisture Sensitivity Level	-	MSL 1

Recommended Operating Conditions

The Recommended Operating Conditions indicate the limits, inside which the device should be operated, to guarantee the performance given in Electrical Specifications. Operating outside these limits may not necessarily cause damage to the device, but the performance may degrade outside the limits of the electrical specifications. For limits, above which damage may occur, see Absolute Maximum Ratings.

Parameter	Min	Nominal	Max	Unit
LO Input Power	13	-	17	dBm
Ambient Temperature	-55	25	100	°C

Sequencing Requirements

There is no requirement to apply power to the ports in a specific order. However, it is recommended to provide a 50Ω termination to each port before applying power. This is a passive diode mixer that requires no DC bias.

Electrical Specifications

The electrical specifications apply at TA=+25°C in a 50Ω system. Typical data shown is for a down conversion application with a +15dBm sine wave LO input.

Parameter	Port Configuration	Test Conditions	Min	Typ	Max	Unit
Conversion Loss ¹	A	RF/LO = 2 - 12 GHz I = 0.2 - 3 GHz	-	9	-	dB
Conversion Loss ²	A	RF/LO = 2 - 12 GHz I = DC - 0.2 GHz	-	8.5	11.5	dB
Input 1 dB Gain Compression Point (P1dB)	A	-	-	12	-	dBm
Input IP3	A	RF/LO = 2 - 12 GHz I = DC - 0.2 GHz	-	25	-	dBm
Conversion Loss ³	B	RF/LO = 2 - 12 GHz I = 0.2 - 3 GHz	-	11.5	-	dB
Conversion Loss ⁴	B	RF/LO = 2 - 12 GHz I = DC - 0.2 GHz	-	10	13	dB
Input 1 dB Gain Compression Point (P1dB)	B	-	-	14	-	dBm
Input IP3	B	RF/LO = 2 - 12 GHz I = DC - 0.2 GHz	-	21	-	dBm
IF Frequency Range	-	-	0	-	3	GHz
Isolation, LO to IF	-	IF/LO = 2 - 12 GHz	-	26	-	dB
Isolation, LO to RF	-	RF/LO = 2 - 12 GHz	-	57	-	dB
Isolation, RF to IF	-	RF/IF = 2 - 12 GHz	-	40	-	dB
LO Frequency Range	-	-	2	-	12	GHz
Noise Figure ⁵	-	RF/LO = 2 - 12 GHz I = DC - 0.2 GHz	-	9	-	dB
RF Frequency Range	-	-	2	-	12	GHz

[1][2][3][4] Measured as a down converter to a fixed 91MHz IF.

[5] Mixer Noise Figure typically measures within 0.5 dB of conversion loss for IF frequencies greater than 5 MHz.

Typical Performance Plots

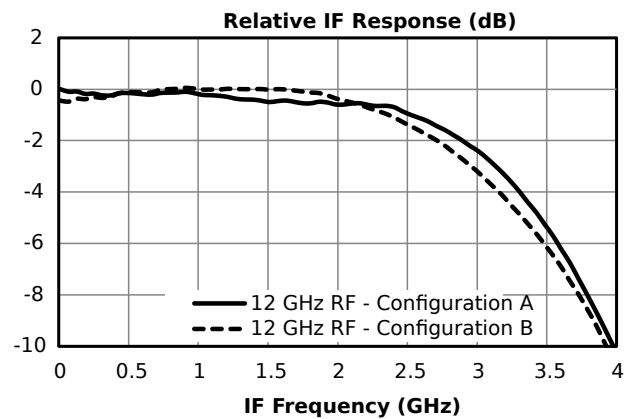
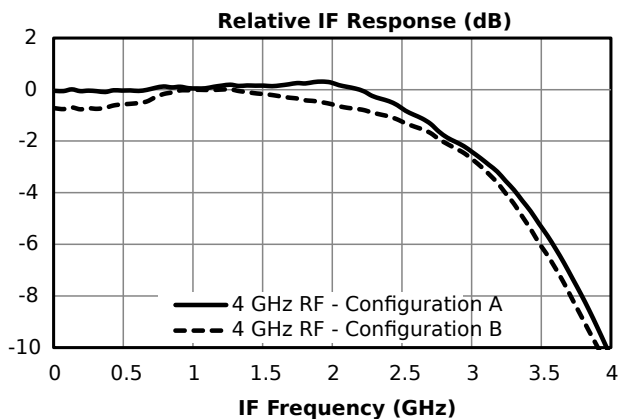
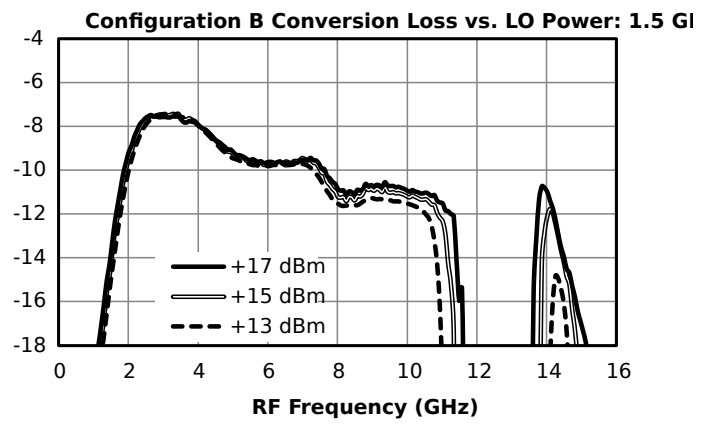
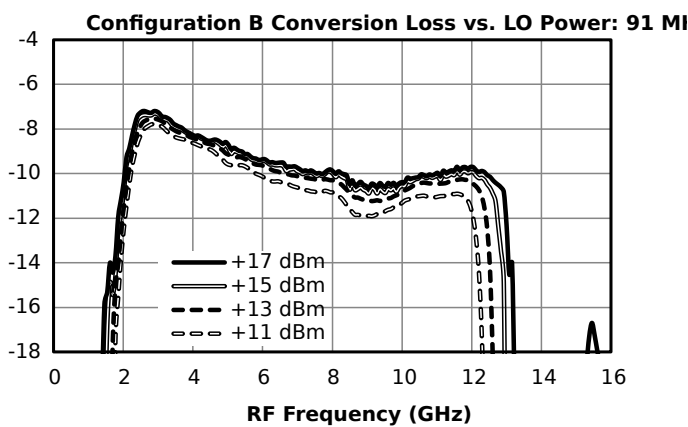
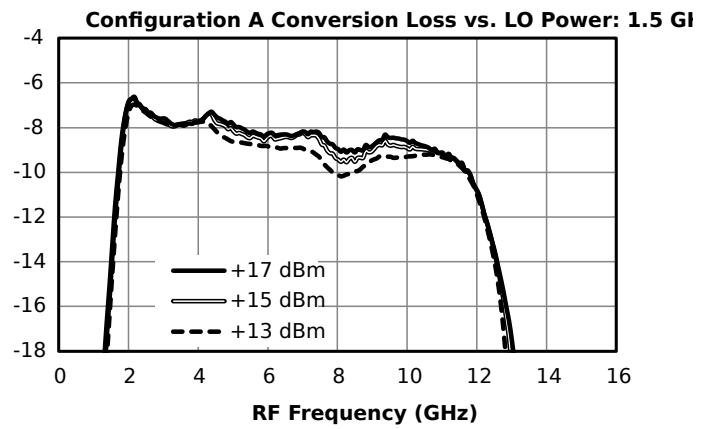
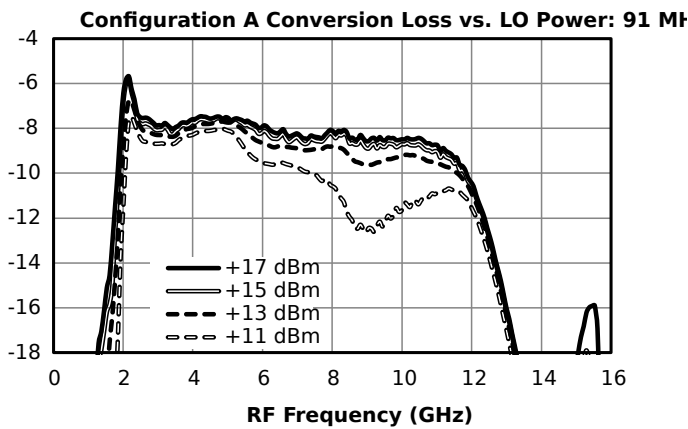
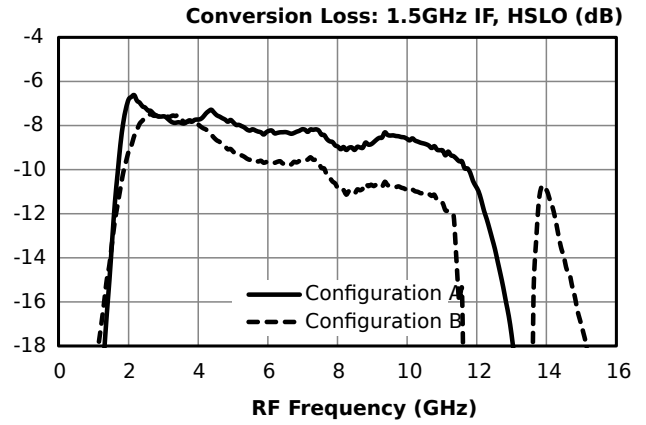
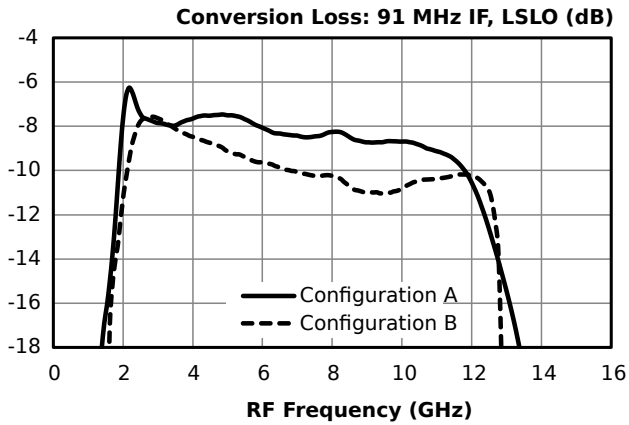

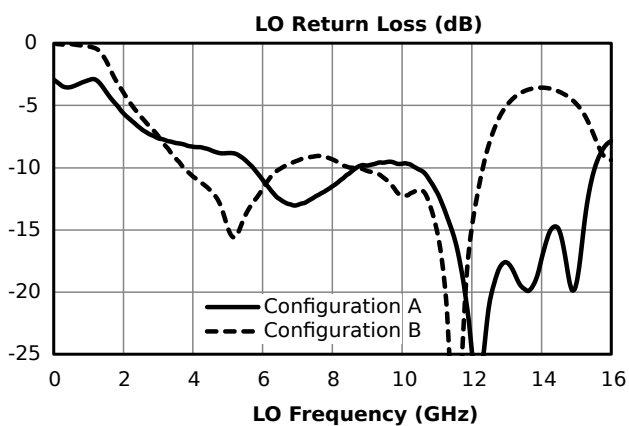
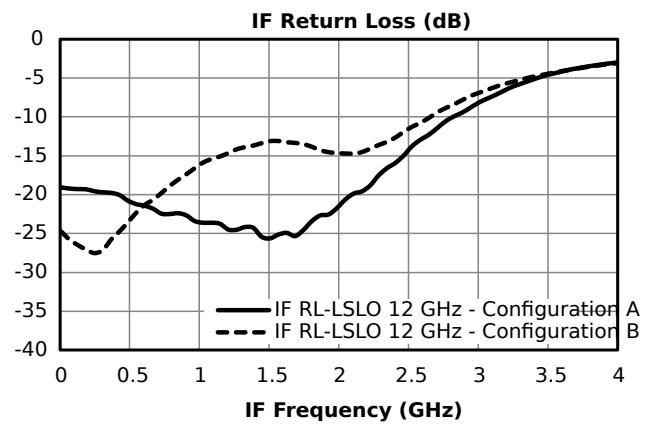
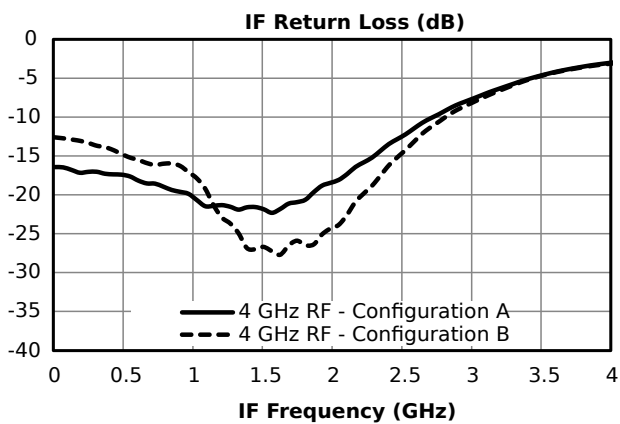
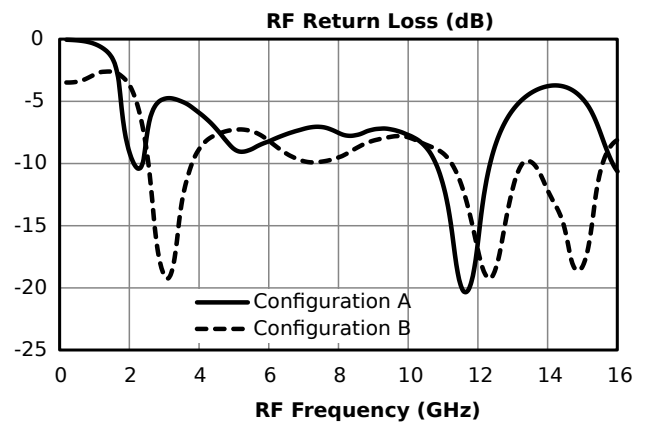
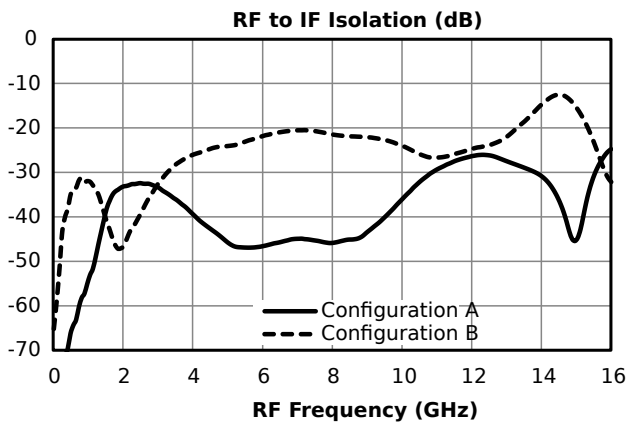
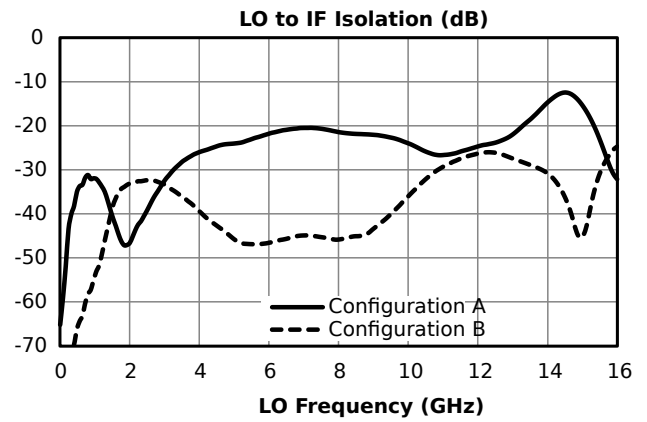
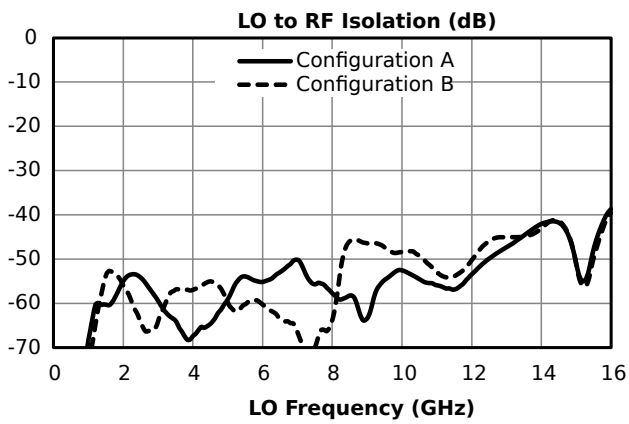

Typical Performance Plots: IP3

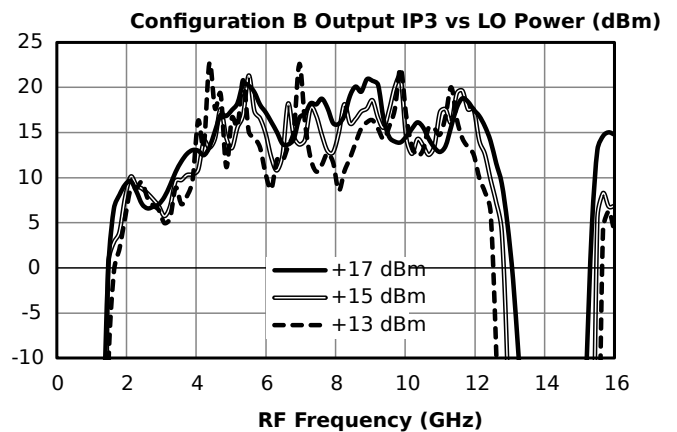
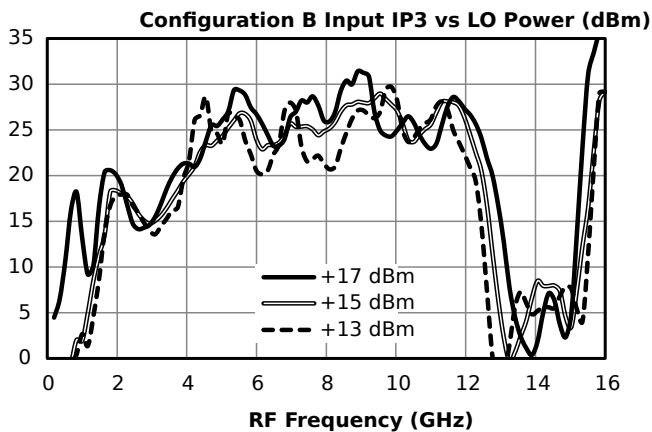
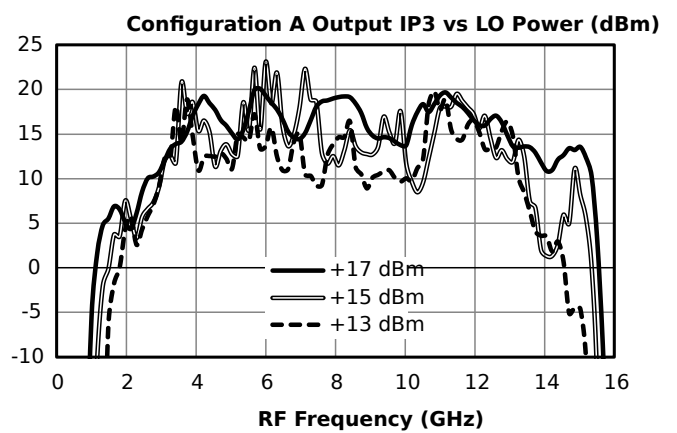
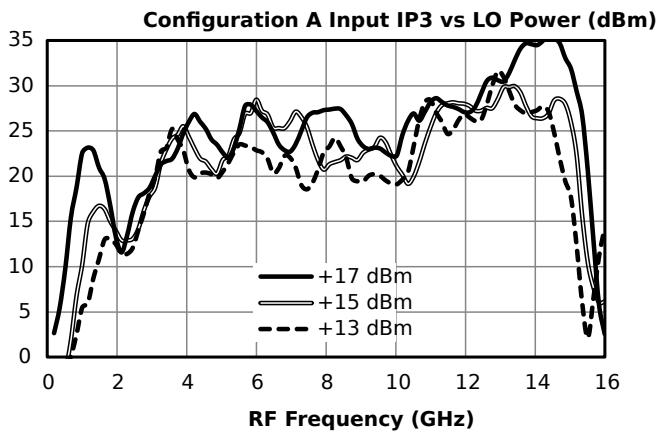
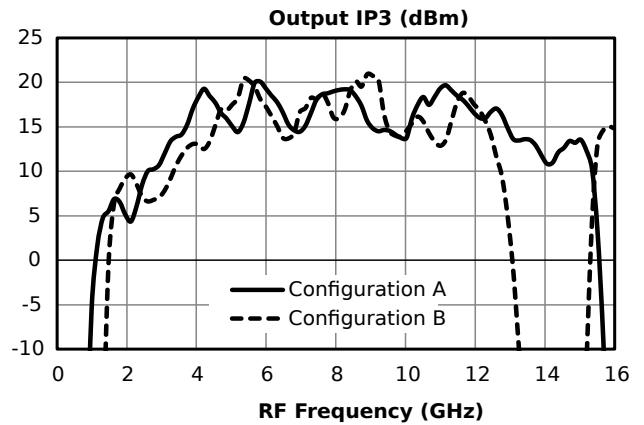
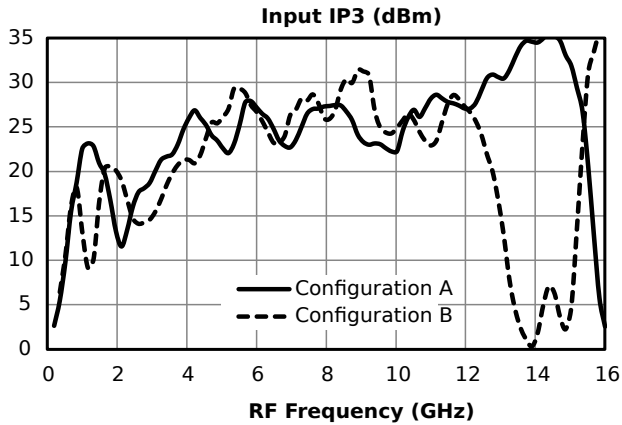

Typical Performance Plots: LO Harmonic Isolation

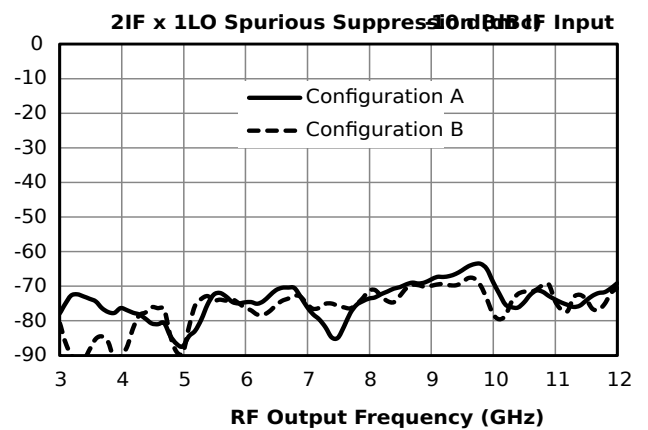
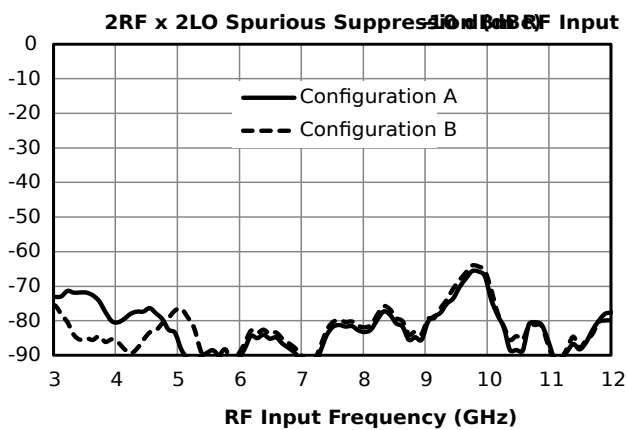
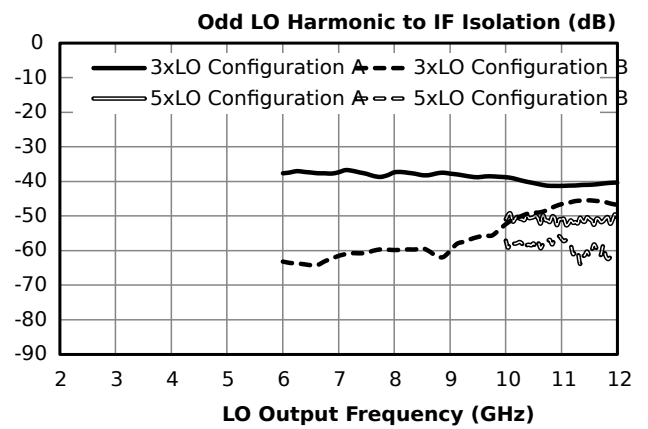
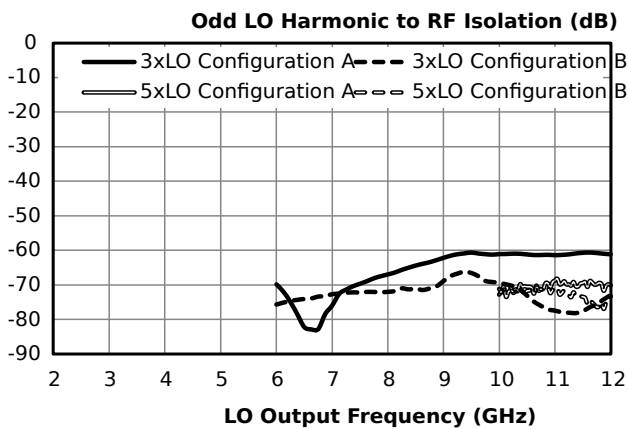
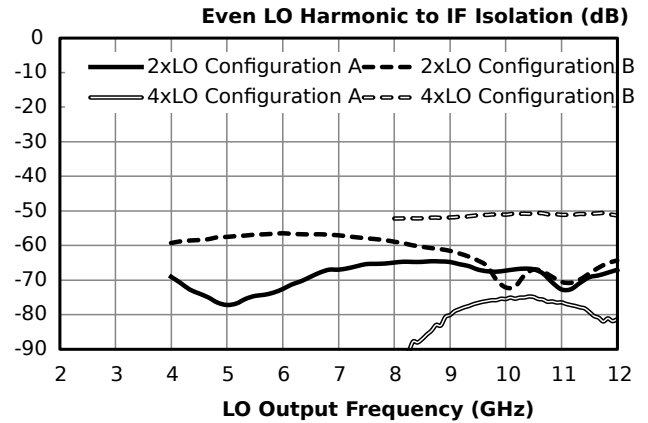
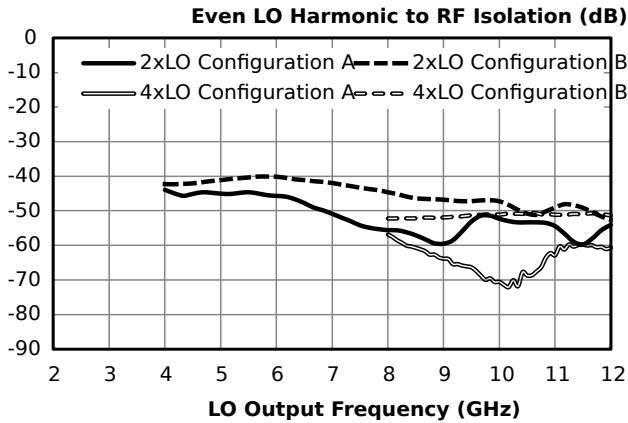

Spur Table

Typical Spurious Performance: Down-Conversion

Typical spurious data is provided by selecting RF and LO frequencies ($\pm m \cdot LO \pm n \cdot RF$) within the RF/LO bands, to create a spurious output within the IF band. The mixer is swept across the full spurious band and the mean is calculated. The numbers shown in the table below are for a -10 dBm RF input. Spurious suppression is scaled for different RF power levels by (n-1), where “n” is the RF spur order. For example, the 2RF x 2LO spur is 81 dBc for a -10 dBm input, so a -20 dBm RF input creates a spur that is (2-1) x (-10 dB) lower, or 91 dBc. Data is shown for the frequency plan in Typical Performance.

Typical Down-conversion spurious suppression (dBc): Config A (B)

-10 dBm RF Input	0xLO	1xLO	2xLO	3xLO	4xLO	5xLO
1xRF	30 (15)	Reference	34 (33)	11 (13)	43 (41)	25 (26)
2xRF	78 (77)	58 (57)	81 (81)	69 (68)	73 (74)	70 (67)
3xRF	114 (107)	61 (63)	91 (93)	78 (79)	90 (94)	69 (72)
4xRF	149 (147)	106 (107)	117 (119)	115 (117)	124 (130)	116 (119)
5xRF	159 (158)	118 (120)	127 (133)	118 (122)	136 (143)	122 (128)

Typical Spurious Performance: Up-Conversion

Typical spurious data is taken by mixing an input within the IF band, with LO frequencies ($\pm m \cdot LO \pm n \cdot IF$), to create a spurious output within the RF output band. The mixer is swept across the full spurious output band and the mean is calculated. The numbers shown in the table below are for a -10 dBm IF input. Spurious suppression is scaled for different IF input power levels by (n-1), where “n” is the IF spur order. For example, the 2IFx1LO spur is typically 73 dBc for a -10 dBm input with a sine-wave LO, so a -20 dBm IF input creates a spur that is (2-1) x (-10 dB) lower, or 83 dBc. Data is shown for the frequency plan in Typical Performance.

Typical Up-conversion spurious suppression (dBc): Config A (B)

-10 dBm RF Input	0xLO	1xLO	2xLO	3xLO	4xLO	5xLO
1xIF	28 (19)	Reference	35 (34)	11 (12)	43 (39)	32 (27)
2xIF	55 (75)	73 (72)	59 (58)	77 (81)	66 (56)	73 (74)
3xIF	100 (83)	73 (71)	84 (84)	64 (66)	87 (88)	72 (69)
4xIF	118 (119)	124 (126)	114 (113)	119 (126)	111 (105)	117 (119)
5xIF	143 (138)	114 (115)	133 (132)	105 (108)	129 (125)	112 (105)

Application Circuit

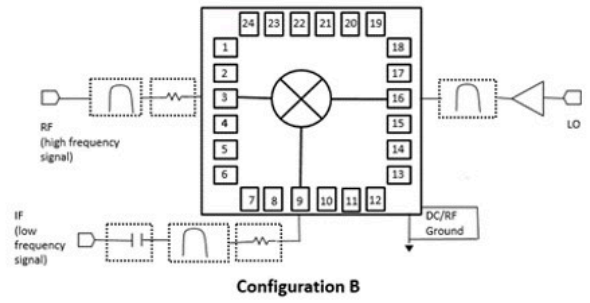
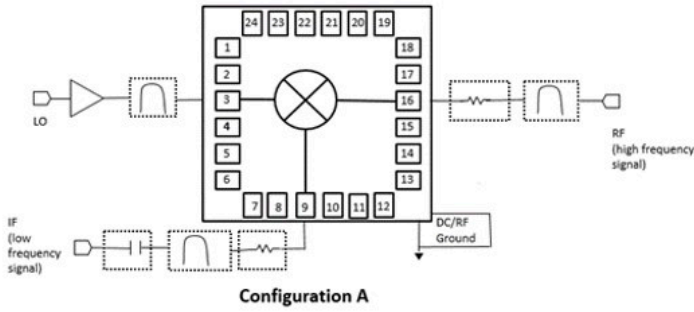

Application Circuit Description

Ports Operation

IF Port – Used as input on an upconversion, output on downconversion, or LO port in a band shifting application. Signals should be connected by 50 ohm microstrip or coplanar traces to well matched broadband 50 ohm sources and loads. Blocking capacitor is recommended if DC voltage is present on the line.

RF Port – Used as input on a downconversion, output on upconversion, or output in a band shifting application. Signals should be connected by 50 ohm microstrip or coplanar traces to well matched broadband 50 ohm sources and loads.

Filtering and Matching- Filtering is generally desired for spurious and image removal on the output port of the mixer. Reflective filters can cause out of band signals to reflect back into the mixer and cause conversion loss ripple, erroneous spurs, and other undesired behaviors. To eliminate these problems it is recommend that the filters be placed as close to the output port as possible. If undesired behavior is still observed, a diplexer with one port terminated or a 1-3 dB attenuator may reduce this problem.

RF Ground – The ground paddle of the QFN should be connected to a low noise RF ground with very low electrical resistance for high frequency operation.

LO Port – The noise floor of the LO input signal should be less than the value of the noise floor plus isolation of the mixer, or a filter is recommended to prevent reduction in dynamic range. An LO amplifier is required if the LO power is below the recommended drive level. It is important to use an amplifier with a broadband 50 ohm match such that it does not reflect spurious signals back into the mixer or other system circuitry.

Mechanical Data

Outline Drawing

Download : [Outline 2D Drawing](#) | [Outline 3D Drawing](#) | [Outline 3D STP](#)

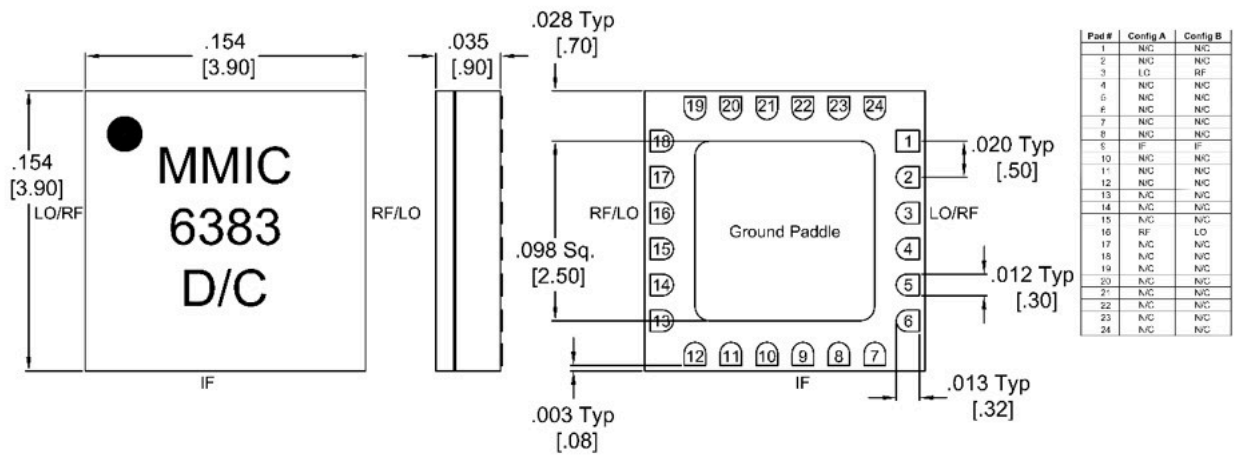

- Substrate material is ceramic.
- I/O Leads and Ground Paddle plating is (from base to finish):

Ni:	8.89um MAX	1.27um MIN
Pd:	0.17um MAX	0.07um MIN
Au	0.254um MAX	0.03um MIN
- All unconnected pads should be connected to PCB RF ground.

Footprint Image

Download : [Footprint Drawing](#)

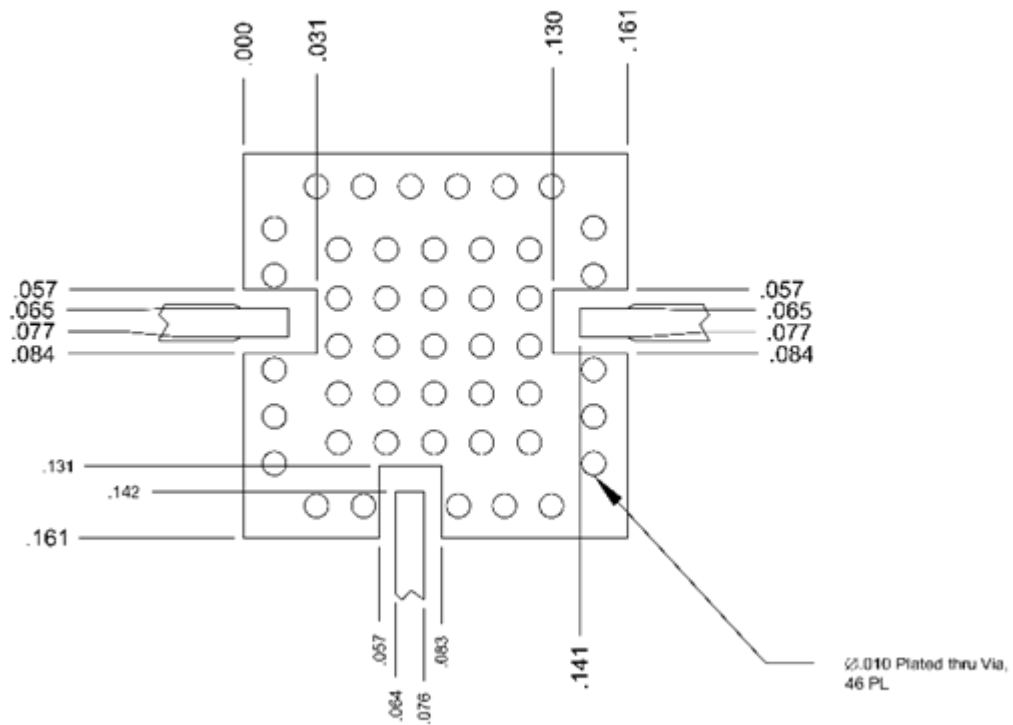

Evaluation Board - Outline Drawing

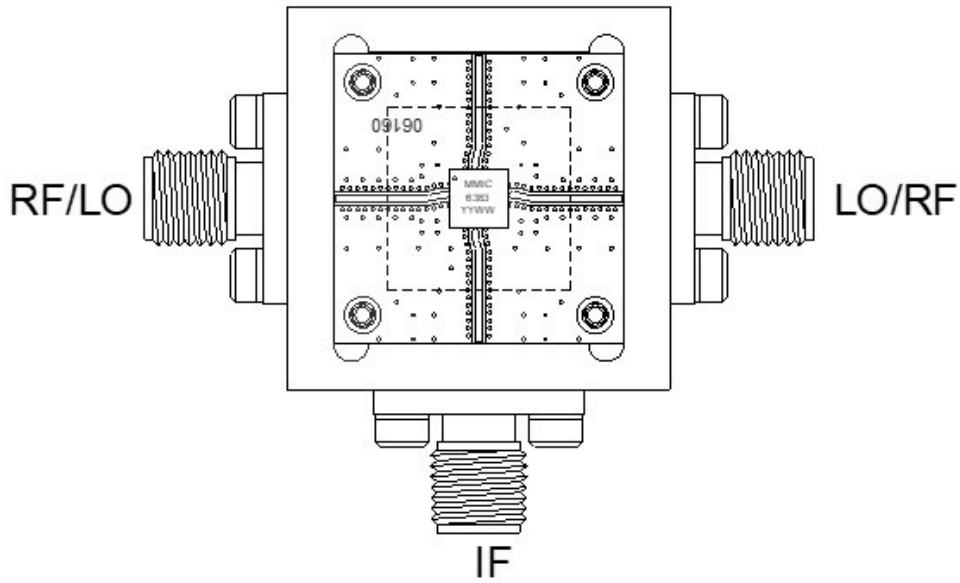

Configuration A	Configuration B	Connector Type
RF	LO	SM A Female
LO	RF	SM A Female
IF	IF	SM A Female

Note: Eval connectors are not removable

DISCLAIMER

MARKI MICROWAVE, INC., ("MARKI") PROVIDES TECHNICAL SPECIFICATIONS AND DATA (INCLUDING DATASHEETS), APPLICATION OR OTHER DESIGN ADVICE, WEB TOOLS, AND OTHER INFORMATION AND RESOURCES "AS IS" AND WITH ALL FAULTS. MARKI DISCLAIMS ALL WARRANTIES, EXPRESS OR IMPLIED, INCLUDING, WITHOUT LIMITATION, ANY IMPLIED WARRANTIES OF MERCHANTABILITY, FITNESS FOR A PARTICULAR PURPOSE, OR NON-INFRINGEMENT.

These resources are intended for developers skilled in the art designing with Marki products. You are solely responsible for (1) selecting the appropriate products for your application, (2) designing, validating, and testing your application, and (3) ensuring your application meets applicable standards and other requirements. Marki makes no guarantee regarding the suitability of its products for any particular purpose, nor does Marki assume any liability whatsoever arising out of your use or application of any Marki product.

Marki grants you permission to use these resources only for development of an application that uses Marki products. Other reproduction or use of these resources is strictly prohibited. No license is granted to any other Marki intellectual property or to any third-party intellectual property. Marki reserves the right to make changes to the product(s) or information contained herein without notice.

MARKI MICROWAVE and T3 MIXER are trademarks or registered trademarks of Marki Microwave, Inc. All other trademarks used are the property of their respective owners.

© 2018 - 2019, Marki Microwave, Inc