

BALE-0003SMG

BROADBAND SURFACE MOUNT BALUN

DEVICE OVERVIEW

General Description

The BALE-0003SMG is a surface-mount broadband balun, hand-tuned for optimal phase and amplitude balance over 10 MHz to 3 GHz bandwidth. Designed for high volume production with cost optimization in mind, it serves as an excellent choice for analog to digital converters, balanced receivers, baseband digital modulations, and signal integrity enhancement. If lower frequency operation is required, the BAL-0003SMG offers performance down to 500 kHz in the same package.

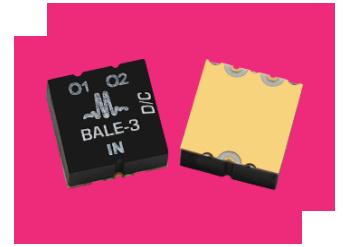

Features

- 2:1 Impedance Ratio
- 10MHz to 3 GHz Balun (Balanced to Unbalanced Transformer)
- Transforms 50Ω to 100Ω Differential Output
- Tuned for Optimal Phase/Amplitude Balance

Applications

- Analog to Digital Converters
- Balanced Receivers
- Baseband Digital Modulation
- Signal Integrity

Functional Block Diagram

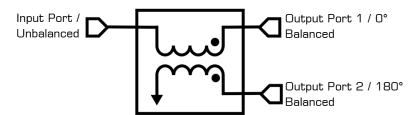

Part Ordering Options

Part Number	Description	Package	Green Status	Product Lifecycle	Export Classification	Recommended Replacement
BALE-0003SMG	BROADBAND SURFACE MOUNT BALUN	SMG	REACH RoHS	End of Life	EAR99	BAL-0003SMG

Table Of Contents

- **Device Overview**
 - General Description
 - Features
 - Applications
 - Functional Block Diagram
- **Port Configuration and Functions**
 - Port Diagram
- **Revision History**
- **Specifications**
 - Absolute Maximum Ratings
 - Package Information
 - Electrical Specifications
 - Typical Mixed Mode Performance Plots
 - Typical Performance Plots
- **Mechanical Data**
 - Outline Drawing
- **Footprint Image**

Revision History

Revision Code	Revision Date	Comment
-	2023-07-01	Datasheet Initial Release

END OF LIFE

Specifications

Absolute Maximum Ratings

Parameter	Maximum Rating	Unit
DC Current	1	A
Maximum Operating Temperature	100	°C
Maximum Storage Temperature	125	°C
Minimum Operating Temperature	-55	°C
Minimum Storage Temperature	-65	°C
RF Power Handling	30	dBm

Package Information

Parameter	Details	Rating
Weight	Package name: SMG	0.24g
Dimensions	-	8.13 x 8.13mm
Moisture Sensitivity Level	-	MSL 1

END OF LIFE

Electrical Specifications

Specifications guaranteed from -55 to +100°C, measured in a 50Ω system.

Parameter	Test Conditions	Minimum Frequency (GHz)	Maximum Frequency (GHz)	Min	Typ	Max	Unit
Impedance Ratio	-	0.01	3	-	2:1	-	
Amplitude Balance	-	0.01	3	-	0.2	0.8	dB
Common Mode Rejection	-	0.01	3	25	42	-	dB
Impedance	-	-	-	-	50	-	Ω
Insertion Loss as a Mode Converter	-	0.01	3	-	4	5	dB
Isolation	-	0.01	3	-	9	-	dB
Nominal Phase Shift	-	0.01	3	-	180	-	°
Phase Balance	-	0.01	3	-	1	8	°
Return Loss (Common)	-	0.01	3	-	19	-	dB
Return Loss (Output)	-	0.01	3	-	15	-	dB

END OF LIFE

Electrical Specifications - Specifications guaranteed from -55 to +100°C, measured in a 50Ω system.

Typical Mixed Mode Performance Plots

Mixed mode scattering parameters are used to characterize differential circuits. For Jbaluns, this means that the 0° and 180° ports become a single 100Ω differential port and the common port remains the same 50Ω common port. The two-port s-parameters of the balun are then characterized based on differential (d), common mode (c), or single-ended (s) signals. Sds21 is the differential output response given a single ended input.

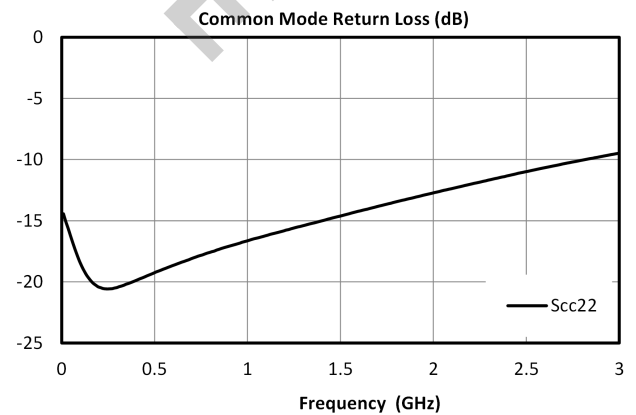
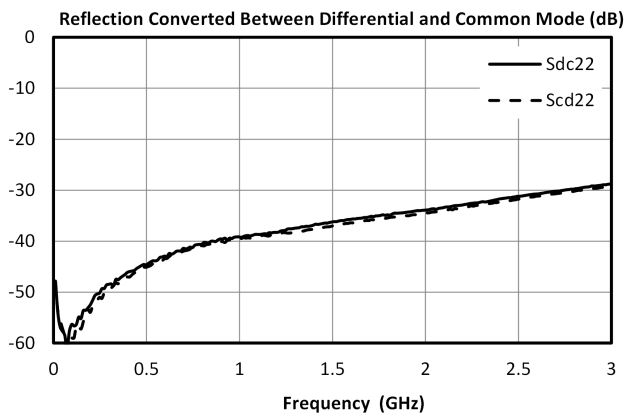
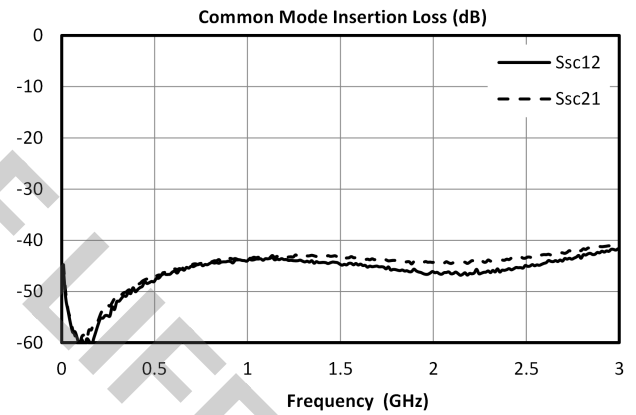
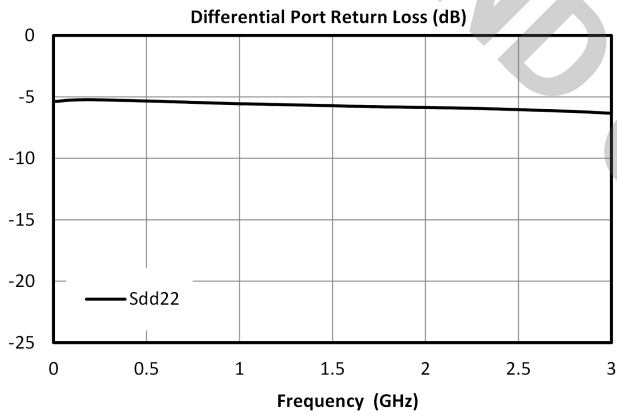
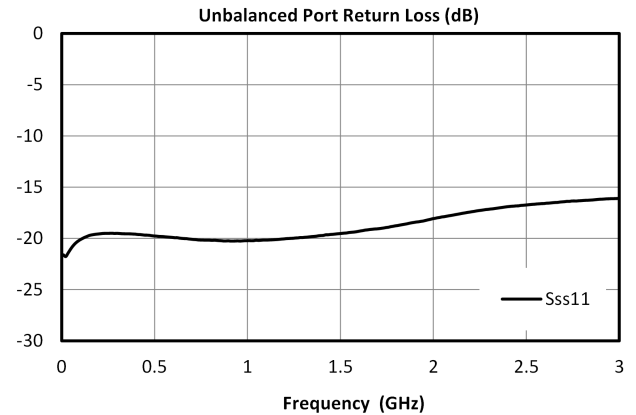
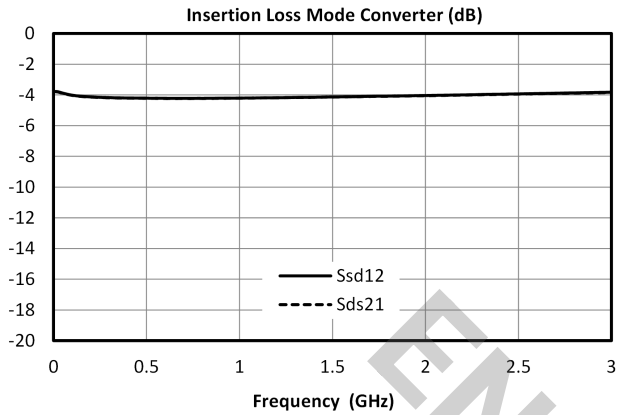

Typical Performance Plots

Three port scattering parameters measured as three single-ended 50Ω ports showing relationship between any two ports.

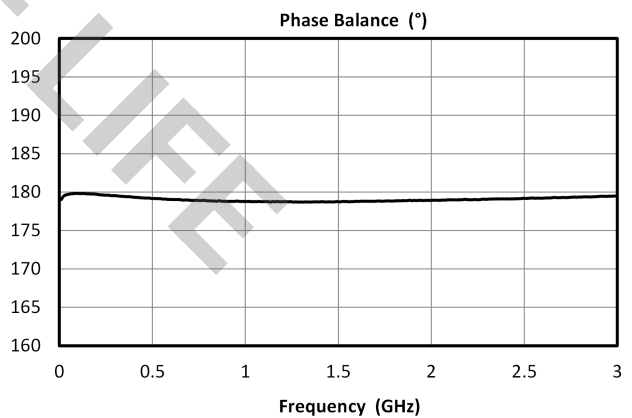
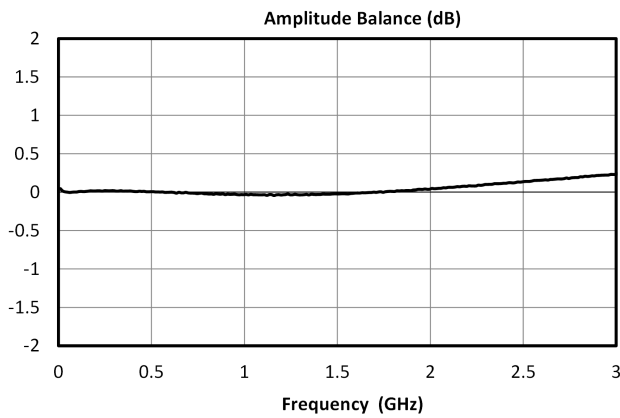
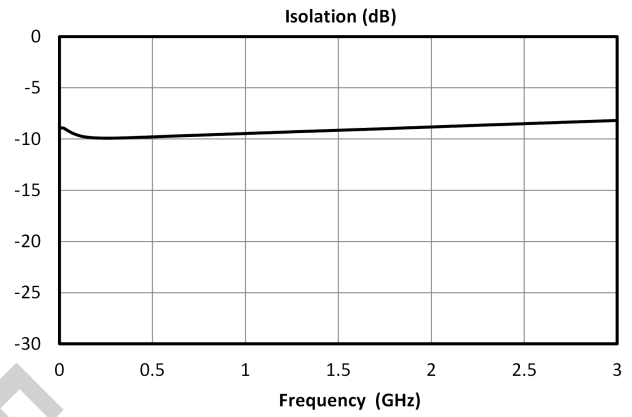
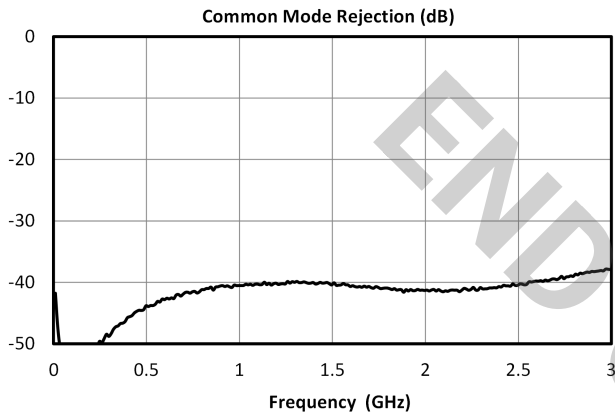
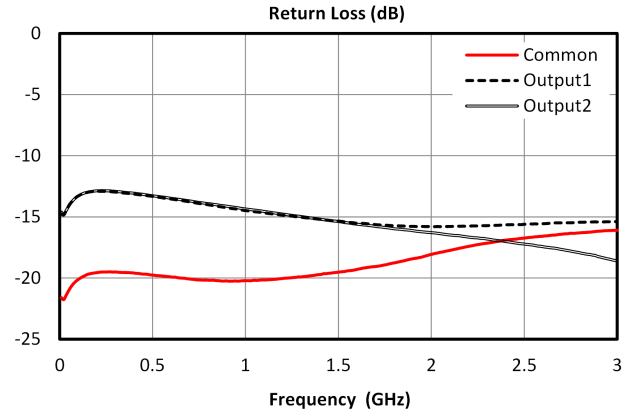
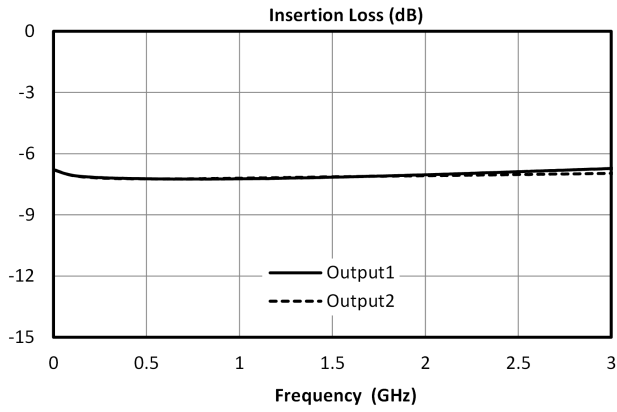

Mechanical Data

Outline Drawing

Download : [Outline 2D Drawing](#) | [Outline 3D Drawing](#) | [Outline 3D STP](#)

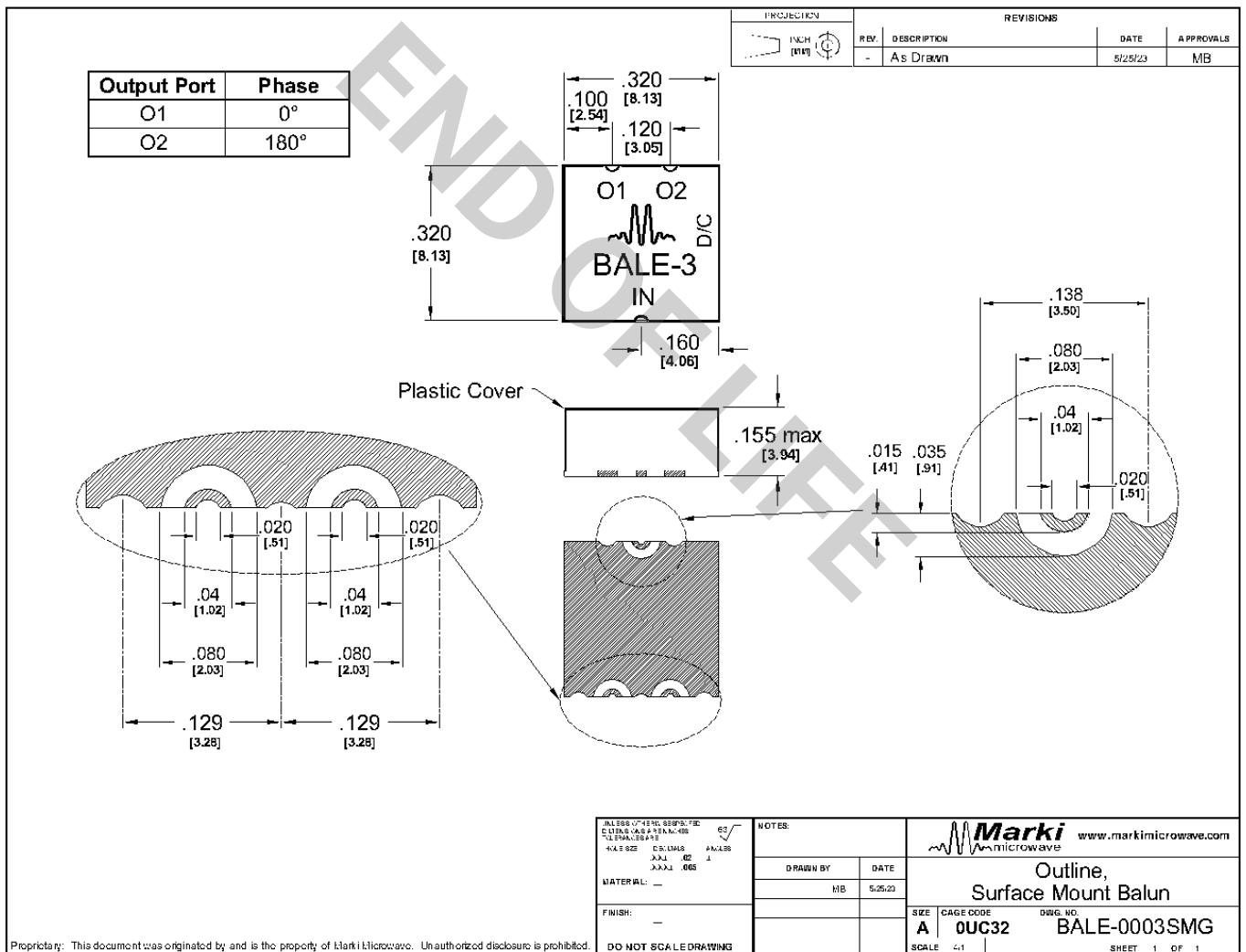

Proprietary: This document was originated by and is the property of Marki Microwave. Unauthorized disclosure is prohibited.

Footprint Image

Download : [Footprint Drawing](#)

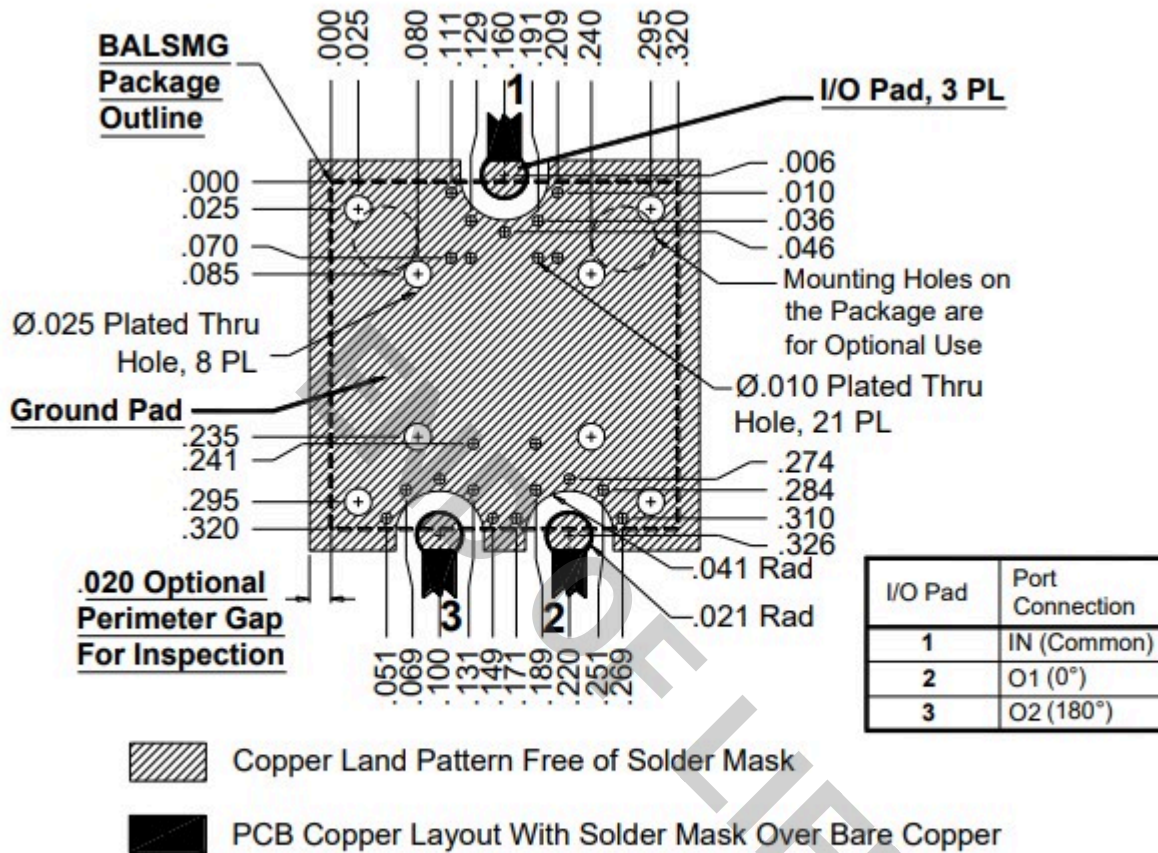

Note: Trace widths shown are for Rogers RO5880/Taconic TLY-5, .010" thick, ½ Oz copper. Widths may need to be modified for other materials.

DISCLAIMER

MARKI MICROWAVE, LLC., ("MARKI") PROVIDES TECHNICAL SPECIFICATIONS AND DATA (INCLUDING DATASHEETS), APPLICATION OR OTHER DESIGN ADVICE, WEB TOOLS, AND OTHER INFORMATION AND RESOURCES "AS IS" AND WITH ALL FAULTS. MARKI DISCLAIMS ALL WARRANTIES, EXPRESS OR IMPLIED, INCLUDING, WITHOUT LIMITATION, ANY IMPLIED WARRANTIES OF MERCHANTABILITY, FITNESS FOR A PARTICULAR PURPOSE, OR NON-INFRINGEMENT.

These resources are intended for developers skilled in the art designing with Marki products. You are solely responsible for (1) selecting the appropriate products for your application, (2) designing, validating, and testing your application, and (3) ensuring your application meets applicable standards and other requirements. Marki makes no guarantee regarding the suitability of its products for any particular purpose, nor does Marki assume any liability whatsoever arising out of your use or application of any Marki product.

Marki grants you permission to use these resources only for development of an application that uses Marki products. Other reproduction or use of these resources is strictly prohibited. No license is granted to any other Marki intellectual property or to any third-party intellectual property. Marki reserves the right to make changes to the product(s) or information contained herein without notice.

MARKI MICROWAVE and T3 MIXER are trademarks or registered trademarks of Marki Microwave, LLC. All other trademarks used are the property of their respective owners.

© 2023, Marki Microwave, LLC

END OF LIFE