

EVB-ATN06-0040P

Evaluation Board, 6dB DC-40 GHz Attenuator

DEVICE OVERVIEW

General Description

The EVB-ATN06-0040P is a connectorized evaluation board for the ATN06-0040PSM DFN packaged surface mount DC-40GHz 6dB Attenuator.

[Download s-parameters here](#)

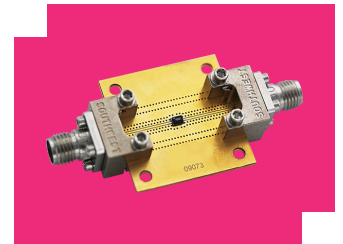

Features

N/A

Applications

- Test Equipment
- Precision Characterization
- High Channel Count Systems
- Amplitude Matching
- 5G transceivers

Functional Block Diagram

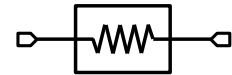

Part Ordering Options

Part Number	Description	Package	Green Status	Product Lifecycle	Export Classification
ATN06-0040PSM	6dB DC-40GHz MMIC Attenuator	DFN	RoHS REACH	Released	EAR99
EVB-ATN06-0040P	Evaluation Board, 6dB DC-40 GHz Attenuator	EVB	REACH RoHS	Released	EAR99

Table Of Contents

- **Device Overview**
 - General Description
 - Features
 - Applications
 - Functional Block Diagram
- **Revision History**
- **Specifications**
- **Mechanical Data**
 - Outline Drawing
- **Evaluation Board**
 - Evaluation Board Outline Drawing

Revision History

Revision Code	Revision Date	Comment
-	2023-10-30	Datasheet Initial Release

Mechanical Data

Outline Drawing

Download : [Outline 2D Drawing](#)

All measurements are typical

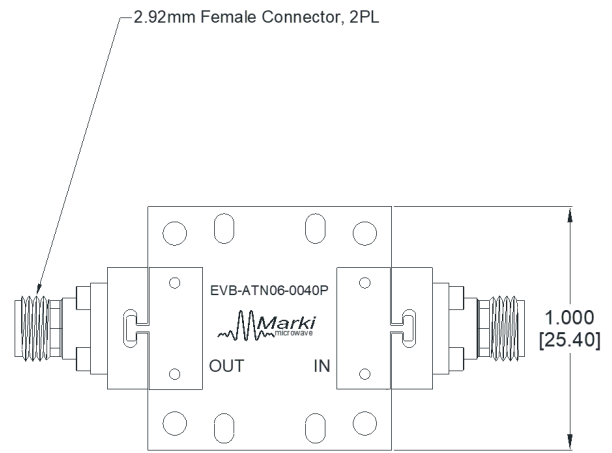
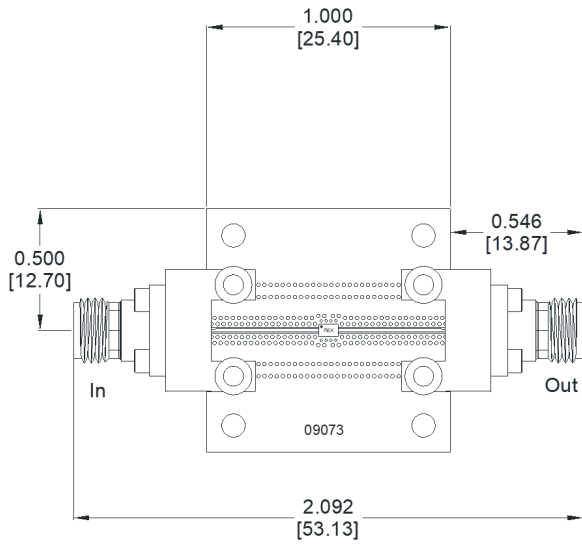
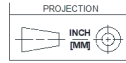

Evaluation Board - Outline Drawing

All measurements are typical

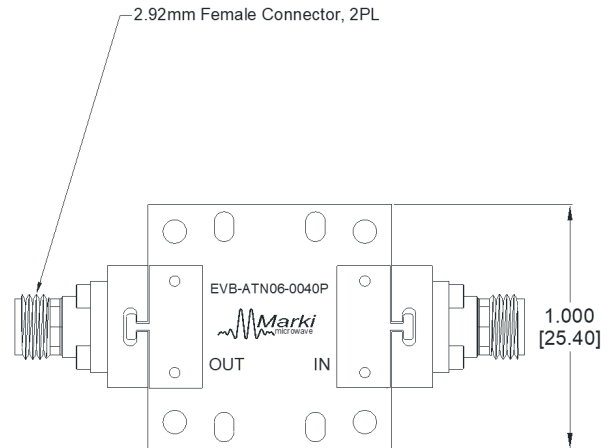
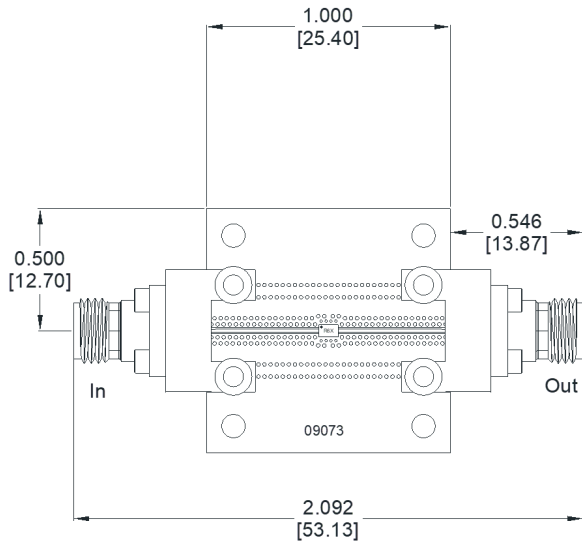
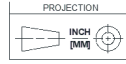

DISCLAIMER

MARKI MICROWAVE, INC., ("MARKI") PROVIDES TECHNICAL SPECIFICATIONS AND DATA (INCLUDING DATASHEETS), APPLICATION OR OTHER DESIGN ADVICE, WEB TOOLS, AND OTHER INFORMATION AND RESOURCES "AS IS" AND WITH ALL FAULTS. MARKI DISCLAIMS ALL WARRANTIES, EXPRESS OR IMPLIED, INCLUDING, WITHOUT LIMITATION, ANY IMPLIED WARRANTIES OF MERCHANTABILITY, FITNESS FOR A PARTICULAR PURPOSE, OR NON-INFRINGEMENT. These resources are intended for developers skilled in the art designing with Marki products. You are solely responsible for (1) selecting the appropriate products for your application, (2) designing, validating, and testing your application, and (3) ensuring your application meets applicable standards and other requirements. Marki makes no guarantee regarding the suitability of its products for any particular purpose, nor does Marki assume any liability whatsoever arising out of your use or application of any Marki product.

Marki grants you permission to use these resources only for development of an application that uses Marki products. Other reproduction or use of these resources is strictly prohibited. No license is granted to any other Marki intellectual property or to any third-party intellectual property. Marki reserves the right to make changes to the product(s) or information contained herein without notice.

MARKI MICROWAVE and T3 MIXER are trademarks or registered trademarks of Marki Microwave, Inc. All other trademarks used are the property of their respective owners.

© 2023, Marki Microwave, Inc