

C-0250

DIRECTIONAL COUPLER

DEVICE OVERVIEW

General Description

The C-0250 is a 2 to 50 GHz ultra-broadband coupler featuring low insertion loss and excellent return losses in a compact connectorized package.

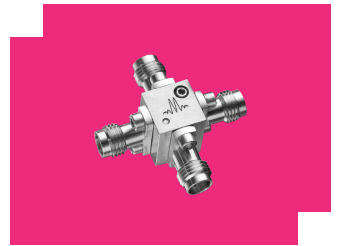

Features

- Low Insertion Loss
- Broadband Performance
- Compact Size and Lightweight

Applications

N/A

Functional Block Diagram

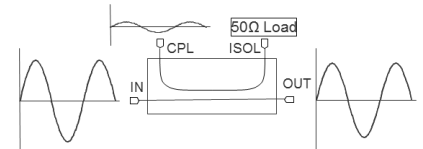

Part Ordering Options

Part Number	Description	Connectors	Green Status	Product Lifecycle	Export Classification
C-0250	DIRECTIONAL COUPLER	<u>Standard</u>	Non-RoHS	Released	EAR99

Table Of Contents

■ Device Overview

- General Description
- Features
- Applications
- Functional Block Diagram

■ Specifications

- Absolute Maximum Ratings
- Package Information
- Electrical Specifications
- Typical Performance

■ Mechanical Data

- Outline Drawing

Specifications

Absolute Maximum Ratings

Parameter	Maximum Rating	Unit
RF Power Handling	15	W
Minimum Operating Temperature	-55	°C
Maximum Operating Temperature	100	°C
Minimum Storage Temperature	-65	°C
Maximum Storage Temperature	125	°C

Package Information

Parameter	Details	Rating
Weight	-	15g
Dimensions	-	7.87 x 7.87 mm

Electrical Specifications

The electrical specifications apply at TA=+25°C in a 50Ω system

Parameter	Test Conditions	Minimum Frequency (GHz)	Maximum Frequency (GHz)	Min	Typ	Max	Unit
Directivity	-	2	25	-	15	-	dB
Directivity	-	25	50	-	10	-	dB
Direct Line Insertion Loss	DC to 25	-	-	-	0.3	0.6	dB
Direct Line Insertion Loss	-	25	50	-	0.7	1.4	dB
Mean Coupling	-	2	-	-	35	-	dB
Mean Coupling	-	50	-	-	12	-	dB
VSWR	-	2	25	-	1.25	1.55	
VSWR	-	25	50	-	1.65	-	

Typical Performance

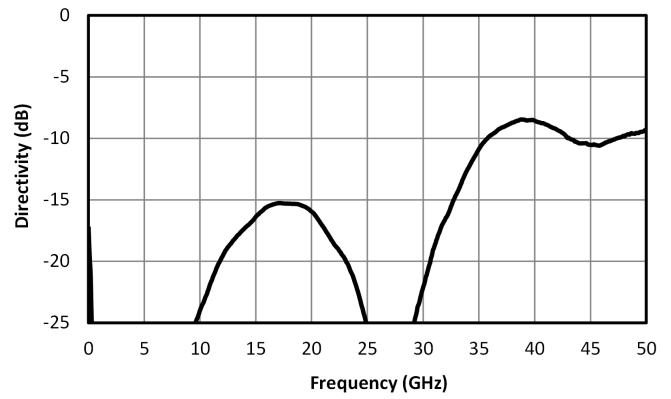
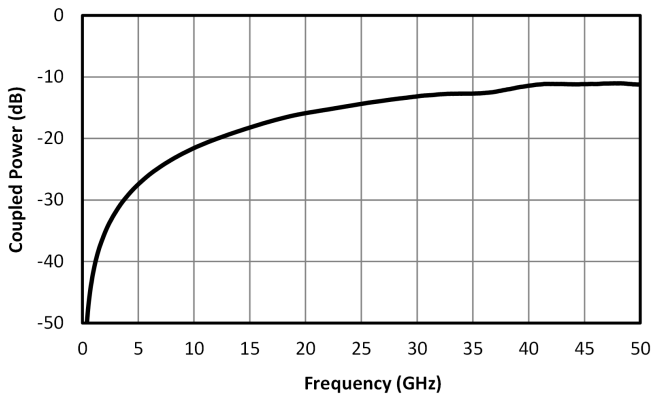
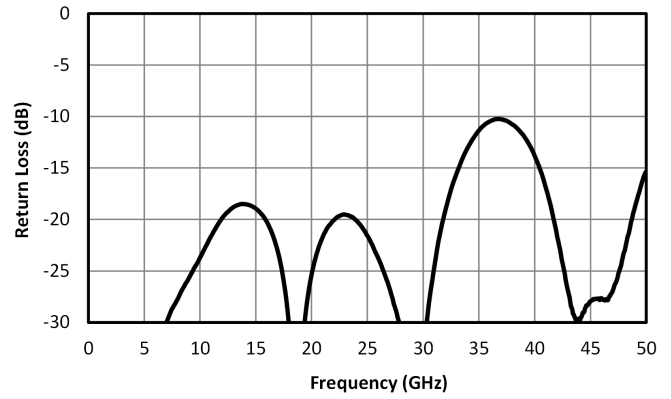
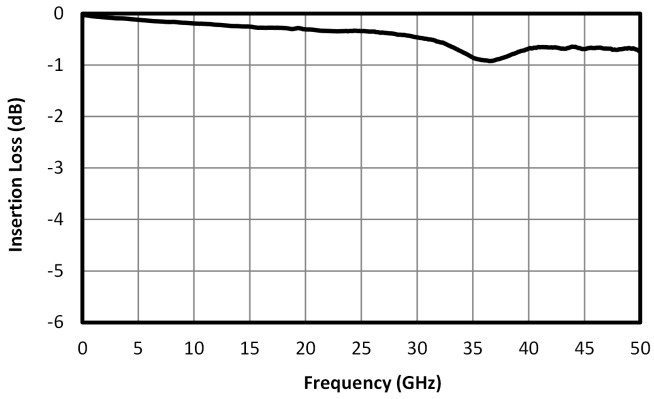

Mechanical Data

Outline Drawing

Download : [Outline 2D Drawing](#) | [Outline 3D Drawing](#) | [Outline 3D STP](#)

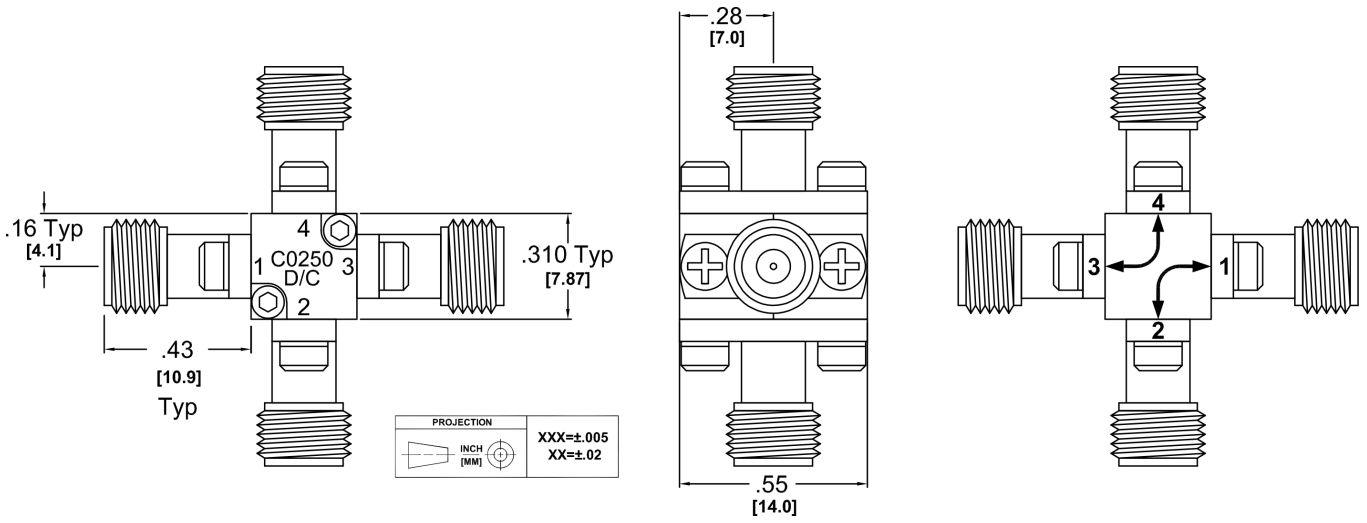

DISCLAIMER

MARKI MICROWAVE, LLC., ("MARKI") PROVIDES TECHNICAL SPECIFICATIONS AND DATA (INCLUDING DATASHEETS), APPLICATION OR OTHER DESIGN ADVICE, WEB TOOLS, AND OTHER INFORMATION AND RESOURCES "AS IS" AND WITH ALL FAULTS. MARKI DISCLAIMS ALL WARRANTIES, EXPRESS OR IMPLIED, INCLUDING, WITHOUT LIMITATION, ANY IMPLIED WARRANTIES OF MERCHANTABILITY, FITNESS FOR A PARTICULAR PURPOSE, OR NON-INFRINGEMENT.

These resources are intended for developers skilled in the art designing with Marki products. You are solely responsible for (1) selecting the appropriate products for your application, (2) designing, validating, and testing your application, and (3) ensuring your application meets applicable standards and other requirements. Marki makes no guarantee regarding the suitability of its products for any particular purpose, nor does Marki assume any liability whatsoever arising out of your use or application of any Marki product.

Marki grants you permission to use these resources only for development of an application that uses Marki products. Other reproduction or use of these resources is strictly prohibited. No license is granted to any other Marki intellectual property or to any third-party intellectual property. Marki reserves the right to make changes to the product(s) or information contained herein without notice.

MARKI MICROWAVE and T3 MIXER are trademarks or registered trademarks of Marki Microwave, LLC. All other trademarks used are the property of their respective owners.

© 2022 - 2026, Marki Microwave, LLC