

MM1-0626SSM-2 GaAs MMIC Double Balanced Mixer

DEVICE OVERVIEW

General Description

The MM1-0626SSM is a highly linear passive GaAs double balanced MMIC mixer suitable for both up and down-conversion applications. As with all Marki Microwave mixers, it features excellent conversion loss, isolation and spurious performance across a broad bandwidth and in a small form factor. The MM1-0626SSM is available in a lead-free, RoHS compliant QFN surface mount package and is compatible with standard leaded and lead-free PCB reflow soldering processes. The MM1-0626SSM is a superior alternative to Marki Microwave surface mount M1 and M3 mixers.



Features

- Compact 3mm QFN SMT Style Package
- Broadband Performance
- Excellent Unit-to-Unit Repeatability
- RoHS Compliant

Applications

N/A

Functional Block Diagram

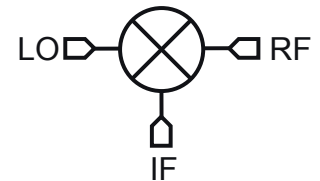

Part Ordering Options

Part Number	Description	Package	Packing Size	Green Status	Product Lifecycle	Export Classification
MM1-0626SSM-2	GaAs MMIC Double Balanced Mixer	QFN	-	REACH RoHS	Released	EAR99
EVAL-MM1-0626S	Evaluation Board, GaAs MMIC 6 - 26 GHz Double Balanced Mixer	EVAL	-	REACH RoHS	Released	EAR99
MM1-0626S-2-TR	Tape and Reel, GaAs MMIC Double Balanced Mixer	QFN	7"	REACH RoHS	Released	EAR99

Table Of Contents

- **Device Overview**
 - General Description
 - Features
 - Applications
 - Functional Block Diagram
- **Port Configuration and Functions**
 - Port Diagram
 - Port Functions
- **Revision History**
- **Specifications**
 - Absolute Maximum Ratings
 - Package Information
 - Recommended Operating Conditions
 - Electrical Specifications
 - Typical Performance
 - Spur Tables
- **Operation**
 - Application Circuit
 - Application Circuit Description
- **Mechanical Data**
 - Outline Drawing
- **Footprint Image**
- **Evaluation Board**
 - Evaluation Board - Performance Data

Revision History

Revision Code	Revision Date	Comment
A	2019-02-01	Change to internal device.

Port Configuration and Functions

Port Diagram

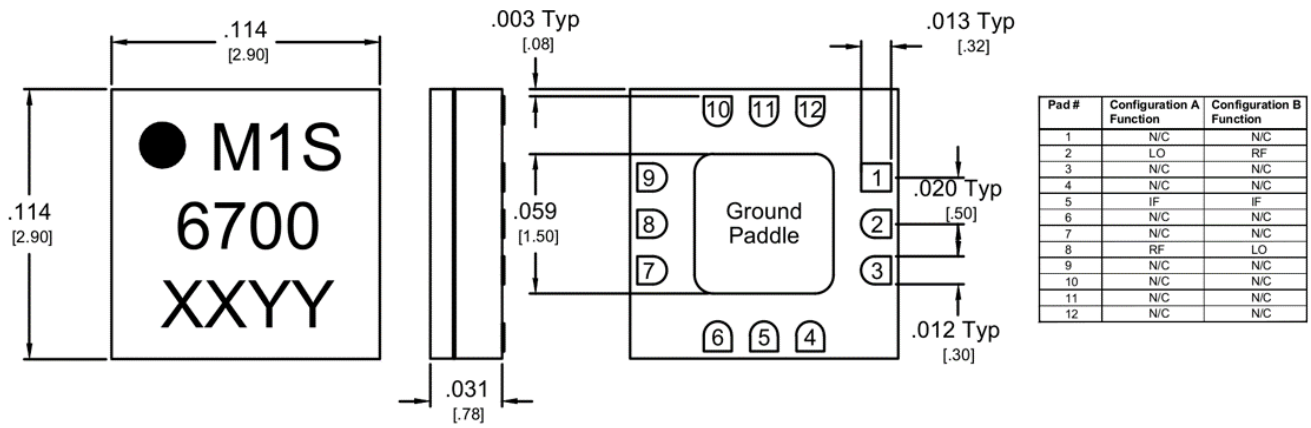

Outline Drawing – 3mm QFN package

- Substrate material is Ceramic.
- I/O Leads and Ground Paddle plating is (from base to finish):

Ni:	8.89um MAX	1.27um MIN
Pd:	0.17um MAX	0.07um MIN
Au	0.254um MAX	0.03um MIN
- All unconnected pads should be connected to PCB RF ground.

Port Functions

Configuration A

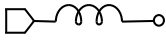
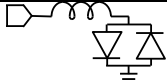
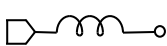
Port	Function	Description	Equivalent Circuit for Package
Port 2	LO	Port 2 is DC open and AC matched to 50 Ohms from 6 to 26.5 GHz. Blocking capacitor is optional.	
Port 5	IF	Port 5 is DC coupled to the diodes. Blocking capacitor is optional.	
Port 8	RF	Port 8 is DC open and AC matched to 50 Ohms from 6 to 26.5 GHz. Blocking capacitor is optional.	

Configuration B

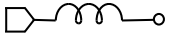
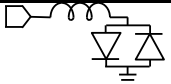
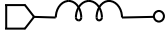
Port	Function	Description	Equivalent Circuit for Package
Port 2	RF	Port 2 is DC open and AC matched to 50 Ohms from 6 to 26.5 GHz. Blocking capacitor is optional.	
Port 5	IF	Port 5 is DC coupled to the diodes. Blocking capacitor is optional.	
Port 8	LO	Port 8 is DC open and AC matched to 50 Ohms from 6 to 26.5 GHz. Blocking capacitor is optional.	

Specifications

Absolute Maximum Ratings

Min and Max limits apply only to our connectorized units and are guaranteed at TA=+25°C. All bare die are 100% DC tested and visually inspected.

Parameter	Maximum Rating	Unit
Maximum Operating Temperature	100	°C
Maximum Storage Temperature	125	°C
Minimum Operating Temperature	-55	°C
Minimum Storage Temperature	-65	°C
Port 5 DC Current	15	mA
RF Power Handling (RF+LO), 100°C	21	dBm
RF Power Handling (RF+LO), 25°C	28	dBm

Package Information

Parameter	Details	Rating
Dimensions	-	3 x 3 mm
Moisture Sensitivity Level	-	MSL 1

Recommended Operating Conditions

Parameter	Min	Nominal	Max	Unit
LO Input Power	17	-	23	-

Electrical Specifications

Specifications guaranteed from -55 to +100°C, measured in a 50Ω system.

Parameter	Port Configuration	Test Conditions	Min	Typ	Max	Unit
Conversion Loss	A	LO=6-26GHz RF=6-26.5GHz IF=DC-9GHz LO drive level=20dBm	-	7.5	-	dB
Input 1 dB Compression	A	LO=6-26GHz RF=6-26.5GHz IF=DC-9GHz LO drive level=18-23dBm	-	14	-	dB
Input IP3	A	LO=6-26GHz RF=6-26.5GHz IF=DC-9GHz LO drive level=18-23dBm	-	27	-	dBm
Conversion Loss	B	LO=6-26GHz RF=6-26.5GHz IF=DC-9GHz LO drive level=20dBm	-	9	-	dB
Input 1 dB Compression	B	LO=6-26.5GHz RF=6-26GHz IF=DC-9GHz LO drive level=17-23dBm	-	14	-	dB
Input IP3	B	LO=6-26.5GHz RF=6-26GHz IF=DC-9GHz LO drive level=17-23dBm	-	29	-	dBm
IF Frequency Range	-	-	0	-	9	GHz
Isolation, LO to IF	-	LO=6-26GHz RF=6-26.5GHz IF=DC-9GHz LO drive level=18-23dBm	-	31	-	dB
Isolation, LO to RF	-	LO=6-26GHz RF=6-26.5GHz IF=DC-9GHz LO drive level=18-23dBm	-	40	-	dB
Isolation, RF to IF	-	LO=6-26GHz RF=6-26.5GHz IF=DC-9GHz LO drive level=18-23dBm	-	31	-	dB
RF Frequency Range	-	-	6	-	26	GHz

Typical Performance

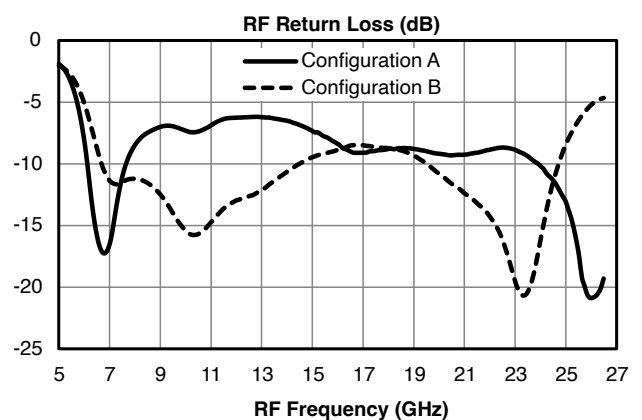
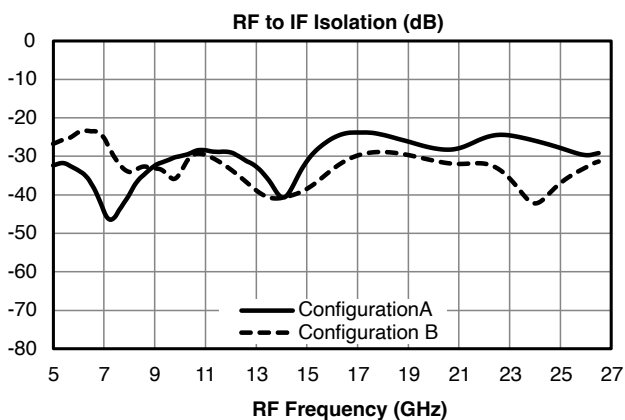
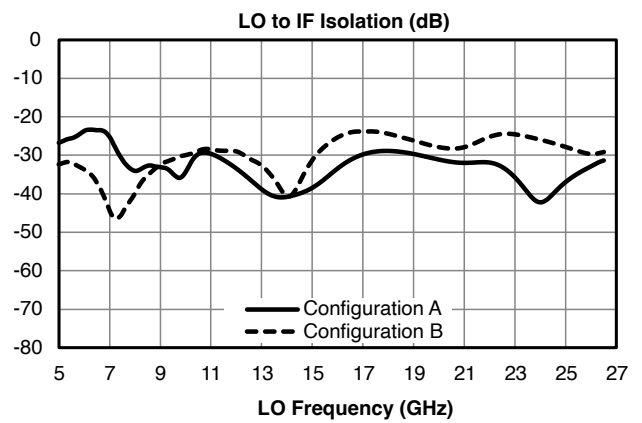
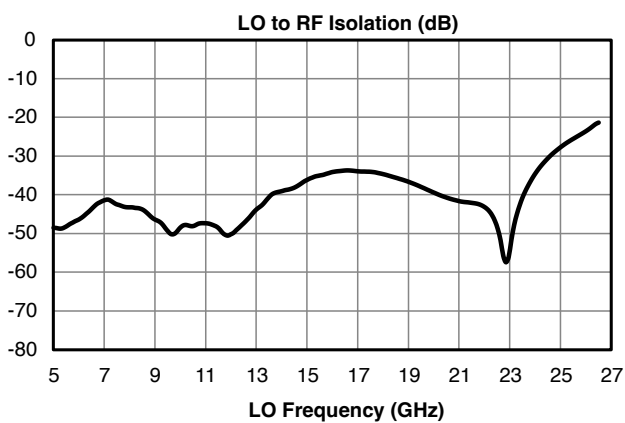
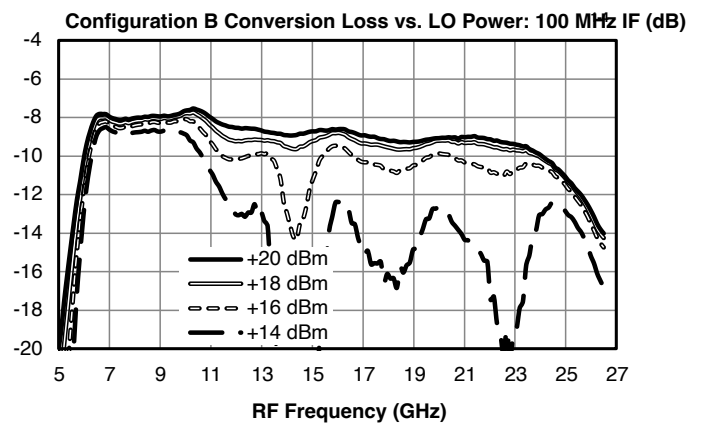
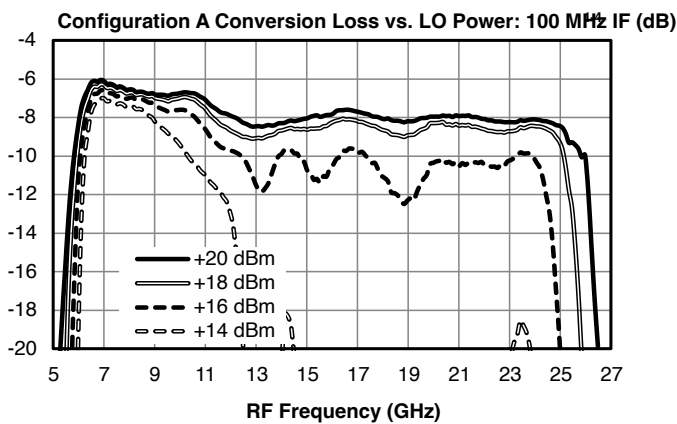
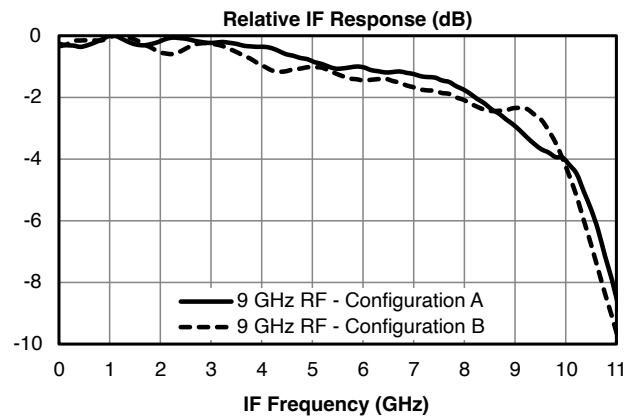
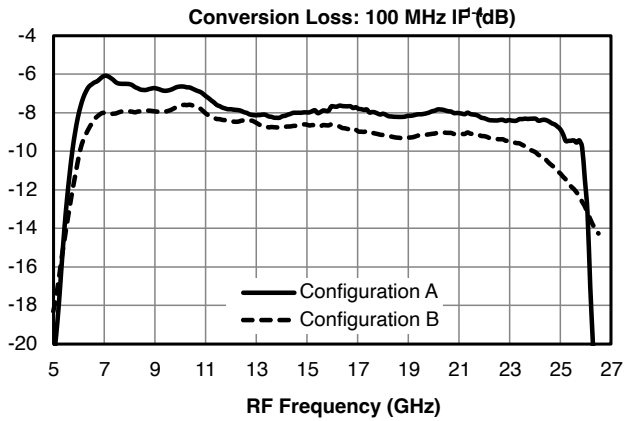

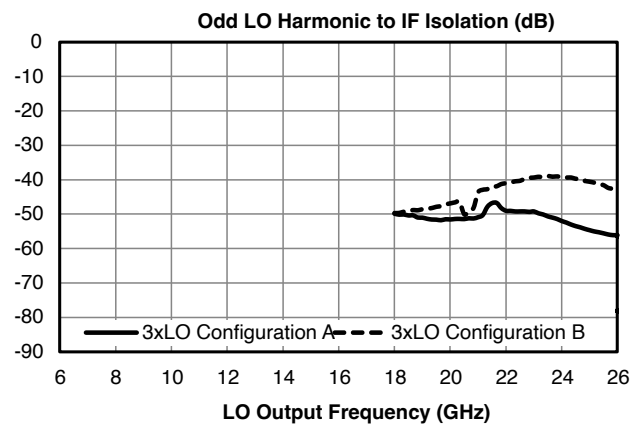
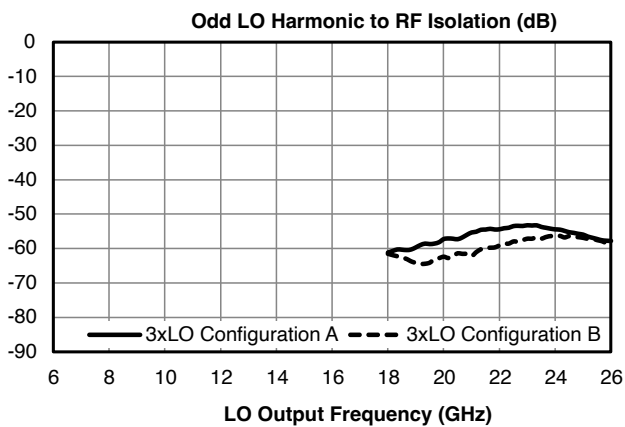
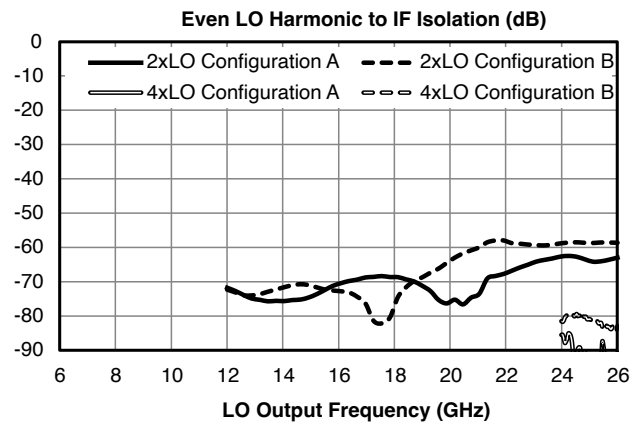
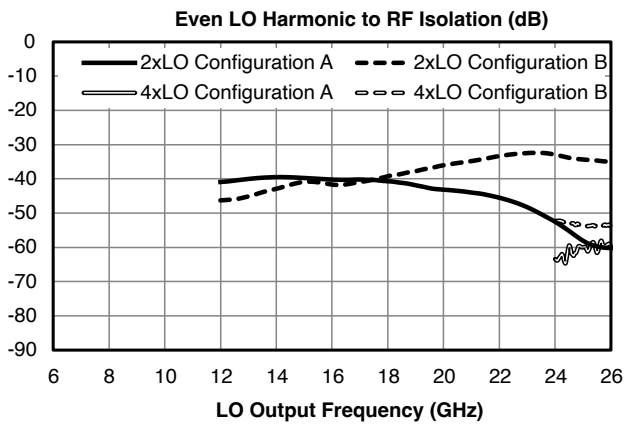
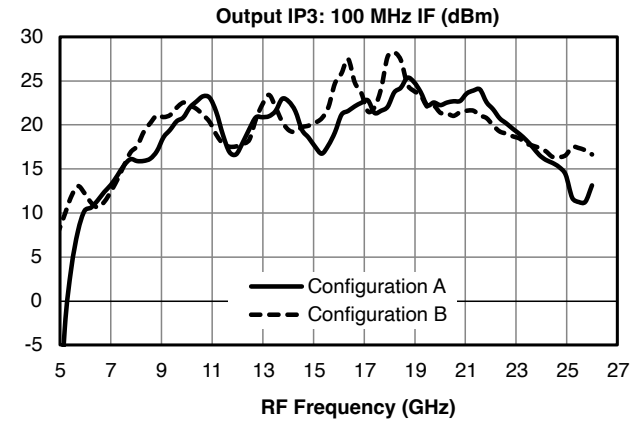
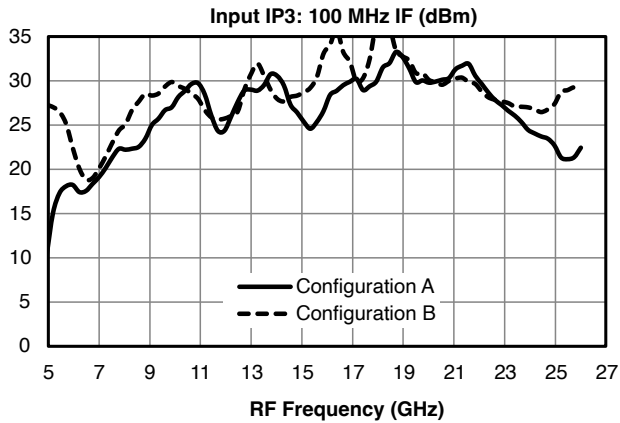
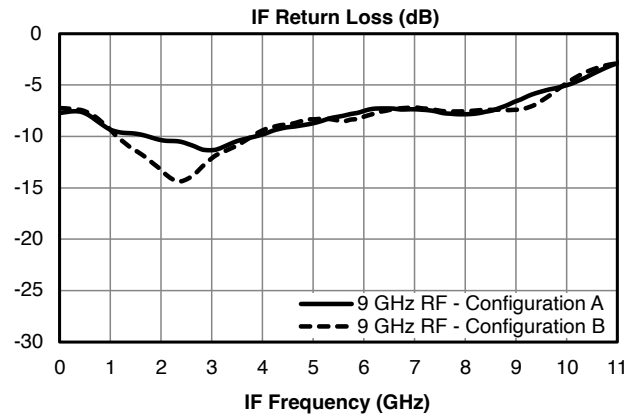
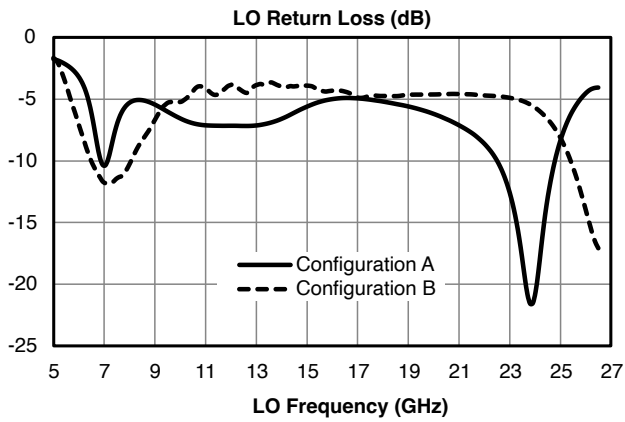

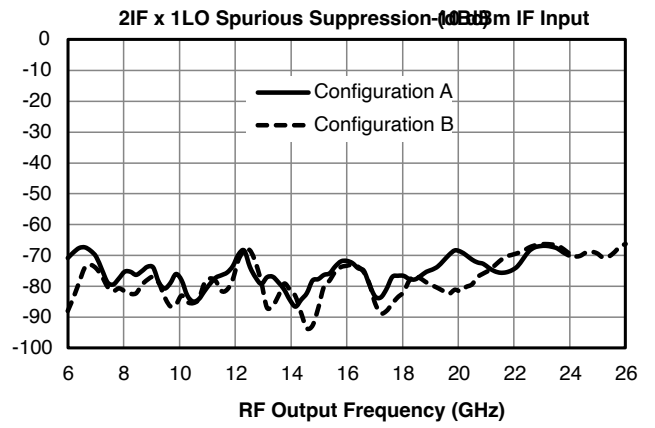
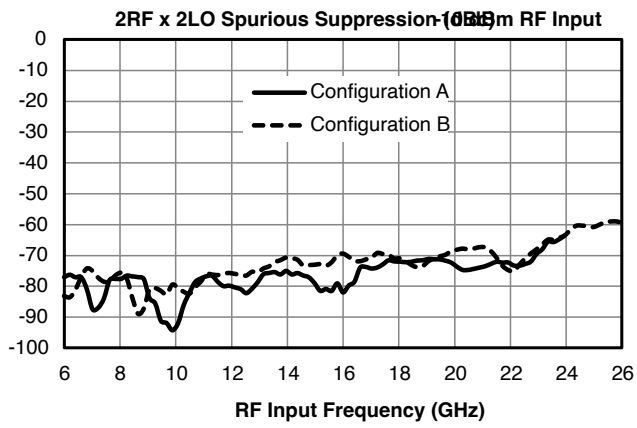

Spur Table

Downconversion Spurious Suppression

Spurious data is taken by selecting RF and LO frequencies (+mLO+nRF) within the 6 to 26 GHz RF/LO bands, which create a 91 MHz IF spurious output. The mixer is swept across the full spurious band and the mean is calculated. The numbers shown in the table below are for a -10 dBm RF input. Spurious suppression is scaled for different RF power levels by (n-1), where “n” is the RF spur order. For example, the 2RFx2LO spur is 77 dBc for the A configuration for a -10 dBm input, so a -20 dBm RF input creates a spur that is (2-1) x (-10 dB) dB lower, or 87 dBc.

Typical Downconversion Spurious Suppression (dBc): A Configuration (B Configuration), Sine Wave LO

-10 dBm RF Input	0xLO	1xLO	2xLO	3xLO	4xLO	5xLO
1xRF	30 (25)	Reference	32 (43)	12 (12)	33 (39)	15 (17)
2xRF	81 (85)	70 (59)	77 (72)	70 (63)	79 (80)	74 (67)
3xRF	112 (113)	70 (74)	88 (94)	80 (84)	86 (97)	74 (78)
4xRF	140 (146)	117 (112)	116 (114)	114 (114)	117 (116)	120 (116)
5xRF	N/A	125 (135)	129 (131)	124 (131)	131 (136)	126 (123)

Specifications are subject to change without notice. Contact Marki Microwave for the most recent specifications and data sheets.

Upconversion Spurious Suppression

Spurious data is taken by mixing a 91 MHz IF with LO frequencies(+mLO+nIF), which creates an RF within the 6 to 26 GHz RF band. The mixer is swept across the full spurious output band and the mean is calculated. The numbers shown in the table below are for a -10 dBm IF input. Spurious suppression is scaled for different IF input power levels by (n-1), where “n” is the IF spur order. For example, the 2IFx1LO spur is typically 75 dBc for the A configuration for a -10 dBm input, so a -20 dBm IF input creates a spur that is (2-1) x (-10 dB) dB lower, or 85 dBc.

Typical Upconversion Spurious Suppression (dBc): A Configuration (B Configuration), Sine Wave LO

-10 dBm RF Input	0xLO	1xLO	2xLO	3xLO	4xLO	5xLO
1xIF	40 (22)	Reference	32 (42)	10 (10)	31 (43)	22 (23)
2xIF	63 (60)	75 (77)	70 (64)	73 (76)	68 (62)	70 (72)
3xIF	111 (112)	74 (81)	87 (100)	72 (72)	84 (94)	72 (73)
4xIF	125 (112)	119 (121)	120 (110)	120 (124)	116 (108)	122 (121)
5xIF	132 (151)	124 (128)	132 (132)	126 (132)	129 (136)	120 (123)

Specifications are subject to change without notice. Contact Marki Microwave for the most recent specifications and data sheets.

Application Circuit

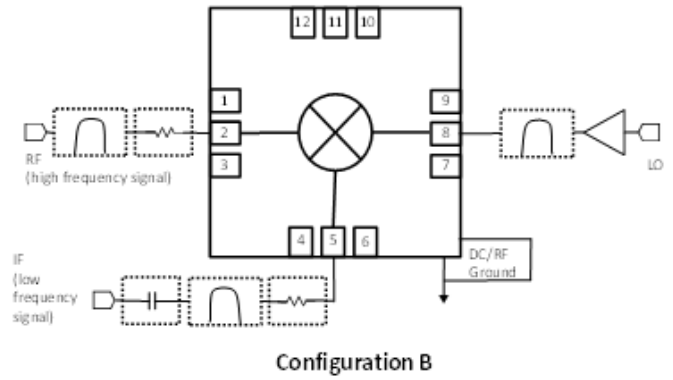
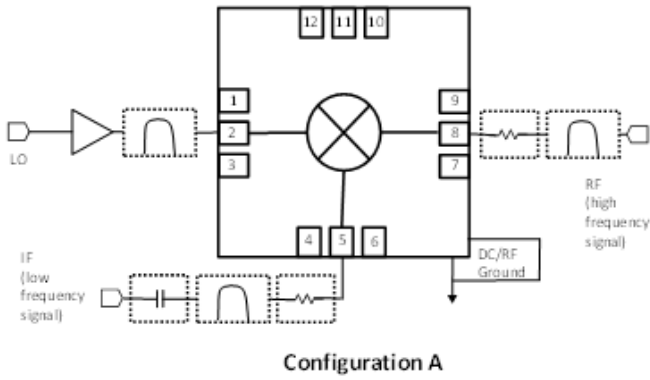

Application Circuit Description

Ports Operation

IF Port – Used as input on an upconversion, output on downconversion, or LO port in a band shifting application. Signals should be connected by 50 ohm microstrip or coplanar traces to well matched broadband 50 ohm sources and loads. Blocking capacitor is recommended if DC voltage is present on the line.

RF Port – Used as input on a downconversion, output on upconversion, or output in a band shifting application. Signals should be connected by 50 ohm microstrip or coplanar traces to well matched broadband 50 ohm sources and loads.

Filtering and Matching- Filtering is generally desired for spurious and image removal on the output port of the mixer. Reflective filters can cause out of band signals to reflect back into the mixer and cause conversion loss ripple, erroneous spurs, and other undesired behaviors. To eliminate these problems it is recommend that the filters be placed as close to the output port as possible. If undesired behavior is still observed, a diplexer with one port terminated or a 1-3 dB attenuator may reduce this problem.

RF Ground – The ground paddle of the QFN should be connected to a low noise RF ground with very low electrical resistance for high frequency operation.

LO Port – The noise floor of the LO input signal should be less than the value of the noise floor plus isolation of the mixer, or a filter is recommended to prevent reduction in dynamic range. An LO amplifier is required if the LO power is below the recommended drive level. It is important to use an amplifier with a broadband 50 ohm match such that it does not reflect spurious signals back into the mixer or other system circuitry.

Mechanical Data

Outline Drawing

Download : [Outline 2D Drawing](#) | [Outline 3D Drawing](#) | [Outline 3D STP](#)

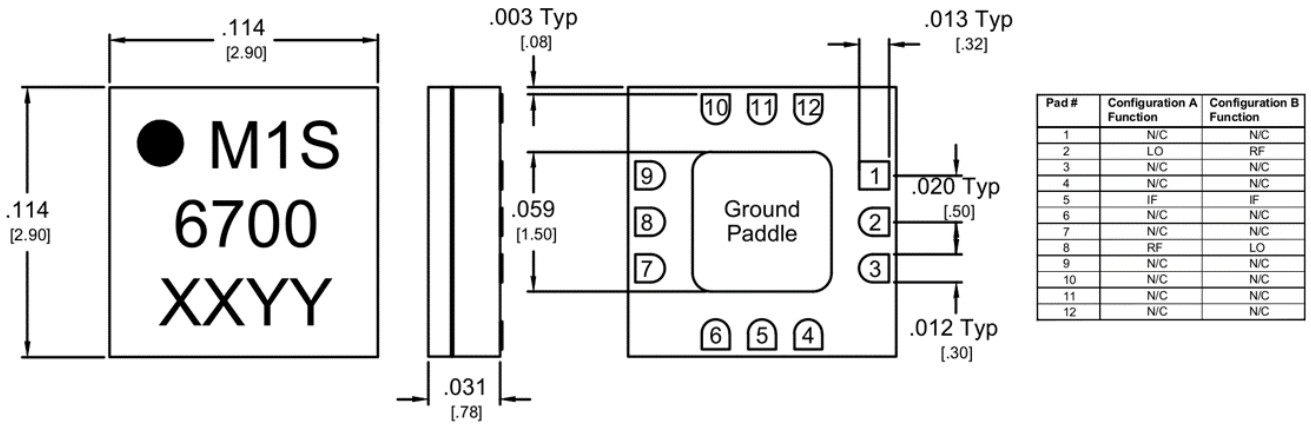

Outline Drawing – 3mm QFN package

- Substrate material is Ceramic.
- I/O Leads and Ground Paddle plating is (from base to finish):

Ni:	8.89um MAX	1.27um MIN
Pd:	0.17um MAX	0.07um MIN
Au	0.254um MAX	0.03um MIN
- All unconnected pads should be connected to PCB RF ground.

Footprint Image

Download : [Footprint Drawing](#)

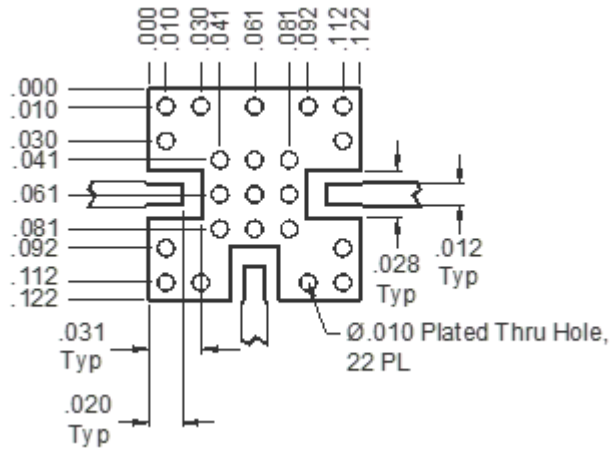

Evaluation Board - Performance Data

Parameter	Test Conditions	Frequency Range (GHz)	Min	Typ	Max	Unit
RF Frequency Range	-	-	6	-	26	GHz
IF Frequency Range	-	0 - 0	0	0	9	GHz

DISCLAIMER

MARKI MICROWAVE, INC., ("MARKI") PROVIDES TECHNICAL SPECIFICATIONS AND DATA (INCLUDING DATASHEETS), APPLICATION OR OTHER DESIGN ADVICE, WEB TOOLS, AND OTHER INFORMATION AND RESOURCES "AS IS" AND WITH ALL FAULTS. MARKI DISCLAIMS ALL WARRANTIES, EXPRESS OR IMPLIED, INCLUDING, WITHOUT LIMITATION, ANY IMPLIED WARRANTIES OF MERCHANTABILITY, FITNESS FOR A PARTICULAR PURPOSE, OR NON-INFRINGEMENT. These resources are intended for developers skilled in the art designing with Marki products. You are solely responsible for (1) selecting the appropriate products for your application, (2) designing, validating, and testing your application, and (3) ensuring your application meets applicable standards and other requirements. Marki makes no guarantee regarding the suitability of its products for any particular purpose, nor does Marki assume any liability whatsoever arising out of your use or application of any Marki product.

Marki grants you permission to use these resources only for development of an application that uses Marki products. Other reproduction or use of these resources is strictly prohibited. No license is granted to any other Marki intellectual property or to any third-party intellectual property. Marki reserves the right to make changes to the product(s) or information contained herein without notice.

MARKI MICROWAVE and T3 MIXER are trademarks or registered trademarks of Marki Microwave, Inc. All other trademarks used are the property of their respective owners.

© 2019, Marki Microwave, Inc