

MMIQ-30120HM

GaAs MMIC mmWave Differential IF IQ Mixer

DEVICE OVERVIEW

General Description

The MMIQ-30120H is a high linearity, passive GaAs MMIC IQ mixer. This is an ultra-broadband mixer spanning 30 to 120 GHz on the RF and LO ports with an IF from DC to 30 GHz. With a typical image rejection of 27dBc from the V through W band, this mixer is an ideal candidate for mmWave I/Q frequency conversion. Both wire bondable die and connectorized modules are available.

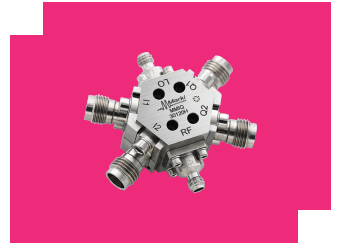

Features

RF/LO Frequency Range:
 30 - 12 GHz
 IF Frequency Range:
 DC - 30 GHz
 I+Q Conversion Loss: 8.5 dB
 Image Rejection: 27 dBc

Applications

- mmWave Frequency Conversion
- Differential IF, Single Side Band & Image Rejection Mixing
- IQ Modulation / Demodulation
- Vector Amplitude Modulation
- Band Shifting

Functional Block Diagram

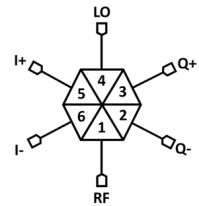

Part Ordering Options

Part Number	Description	Package	Connectors	Green Status	Product Lifecycle	Export Classification
MMIQ-30120HM	GaAs MMIC mmWave Differential IF IQ Mixer	M	<u>Standard</u>	REACH RoHS	Released	EAR99

Table Of Contents

- **Device Overview**
 - General Description
 - Features
 - Applications
 - Functional Block Diagram
- **Port Configuration and Functions**
 - Port Diagram
 - Port Functions
- **Revision History**
- **Specifications**
 - Absolute Maximum Ratings
 - Package Information
 - Recommended Operating Conditions
 - Sequencing Requirements
 - Electrical Specifications
 - Typical Performance Plots
- **Operation**
 - Application Information
 - Application Circuit
 - Application Circuit Description
- **Mechanical Data**
 - Outline Drawing

Revision History

Revision Code	Revision Date	Comment
-	2023-01-01	Datasheet Pre-Release

Port Configuration and Functions

Port Diagram

The mixer may be operated as either a downconverter or an upconverter. Use of the RF or I/Q as the input or output port will depend on the application.

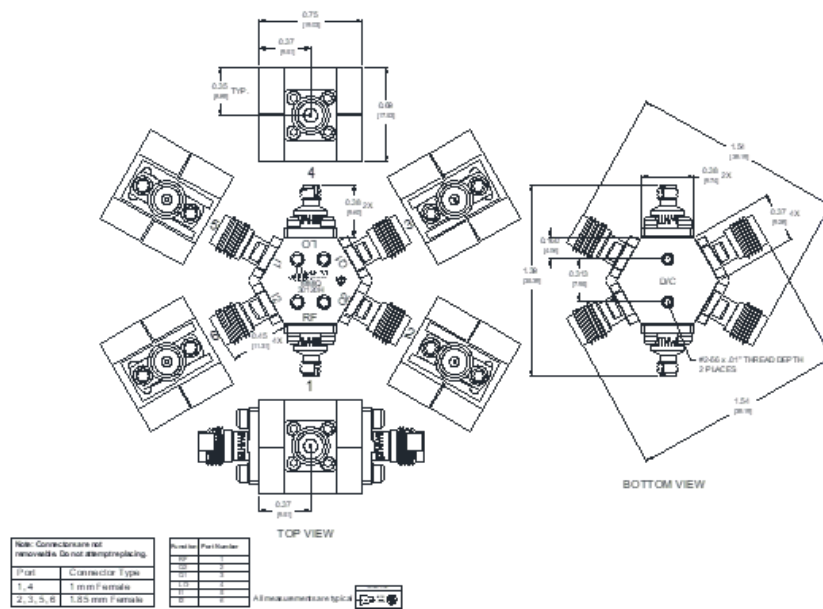

Port Functions

Port	Function	Connector Type	Description	Equivalent Circuit for Package
GND	Ground	-	M package ground taken through metal housing.	GND 
Port 1 / RF	RF Input / Output	1.0F	Port 1 is DC open for the CH and M packages.	P1 
Port 2 / Q2	Q- Input/Output	1.85F	Port 2 is DC open for the CH and M packages.	P2 
Port 3 / Q1	Q+ Input/Output	1.85F	Port 3 is DC open for the CH and M packages.	P3 
Port 4 / LO	LO Input/Output	1.0F	Port 4 is DC open for the CH and M packages	P4 
Port 5 / I1	I+ Input/Output	1.85F	Port 5 is DC open for the CH and M packages	P5 
Port 6 / I2	I- Input/Output	1.85F	Port 6 is DC open for the CH and M packages.	P6 

Specifications

Absolute Maximum Ratings

The Absolute Maximum Ratings indicate limits beyond which damage may occur to the device. If these limits are exceeded, the device may be inoperable or have a reduced lifetime.

Parameter	Maximum Rating	Unit
Maximum Operating Temperature	100	°C
Maximum Storage Temperature	125	°C
Minimum Operating Temperature	-55	°C
Minimum Storage Temperature	-65	°C
Power Handling, at any Port	25	dBm

Package Information

Parameter	Details	Rating
ESD	250 to < 500 Volts	HBM Class 1A
Weight	Package name: M	47g
Dimensions	-	19.03 x 17.53 mm

Recommended Operating Conditions

The Recommended Operating Conditions indicate the limits, inside which the device should be operated, to guarantee the performance given in Electrical Specifications. Operating outside these limits may not necessarily cause damage to the device, but the performance may degrade outside the limits of the electrical specifications. For limits, above which damage may occur, see Absolute Maximum Ratings.

Parameter	Min	Nominal	Max	Unit
Ambient Temperature	-55	25	100	°C
LO Input Power	14	17	21	dBm

Sequencing Requirements

There is no requirement to apply power to the ports in a specific order. However, it is recommended to provide a 50Ω termination to each port before applying power. This is a passive diode mixer that requires no DC bias.

Electrical Specifications

The electrical specifications apply at TA=+25°C in a 50Ω system. Typical data shown is for a down conversion application with a sine wave LO input. Min and Max limits apply only to our connectorized units and are guaranteed at TA=+25°C. All bare die are 100% DC tested and visually inspected.

Parameter	Test Conditions	Minimum Frequency (GHz)	Maximum Frequency (GHz)	Min	Typ	Max	Unit
IF Frequency Range	-	-	-	0	-	30	GHz
Image Rejection ¹	RF/LO = 30 - 120 GHz I+Q = 0.1 GHz	30	120	-	27	-	dBc
Image Reject/Single Sideband Conversion Loss	RF/LO = 30 - 120 GHz I+Q = 0.1 GHz	30	120	-	8.5	-	dB
I/Q Amplitude Balance	RF/LO = 30 - 120 GHz I+Q = 0.1 GHz	30	120	-	1.9	-	dB
I/Q Phase Balance	RF/LO = 30 - 120 GHz I+Q = 0.1 GHz	30	120	-	2.7	-	°
Isolation, LO to RF	RF/LO = 30 - 120 GHz	30	120	-	40	-	dB
LO Frequency Range	-	-	-	30	-	120	GHz
RF Frequency Range	-	-	-	30	-	120	GHz

^[1] Image Rejection and Single sideband performance plots are defined by the upper sideband (USB) or lower sideband (LSB) with respect to the LO signal. Plots are defined by which sideband is selected by the external IF quadrature hybrid. LO power used for characterization varies by band. Saturated amplifiers used were A-3567 and a mmWave LO Driver amplifier

Typical Performance Plots

Unless stated otherwise, all measurements were conducted with a single I1/I2 and a single Q1/Q2. Differential IFs were not recombined through a balun.

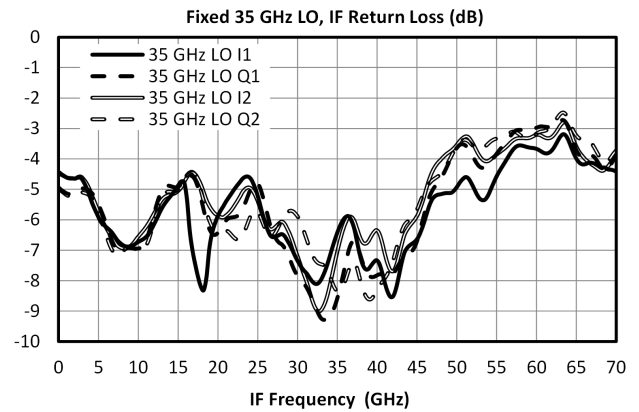
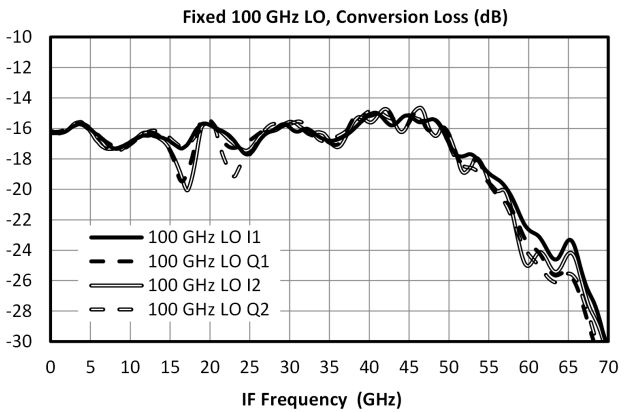
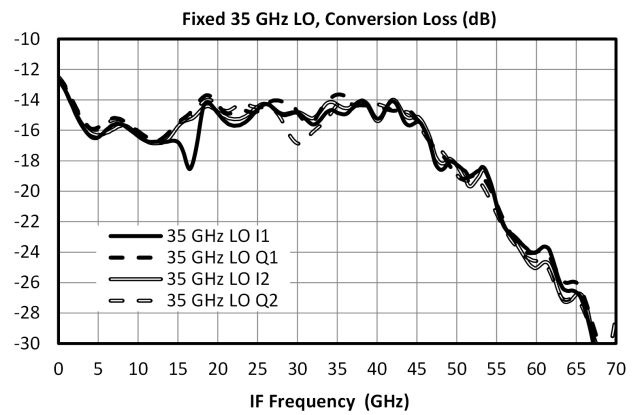
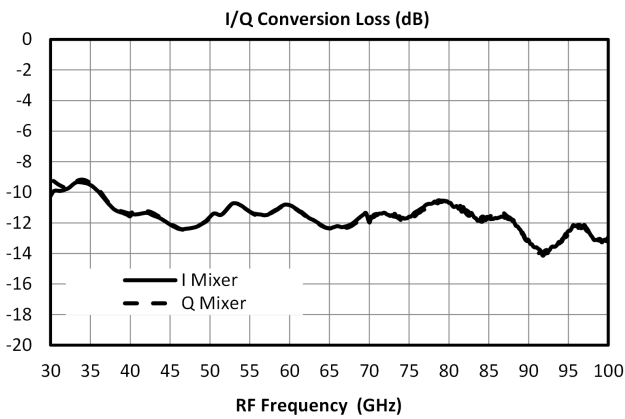
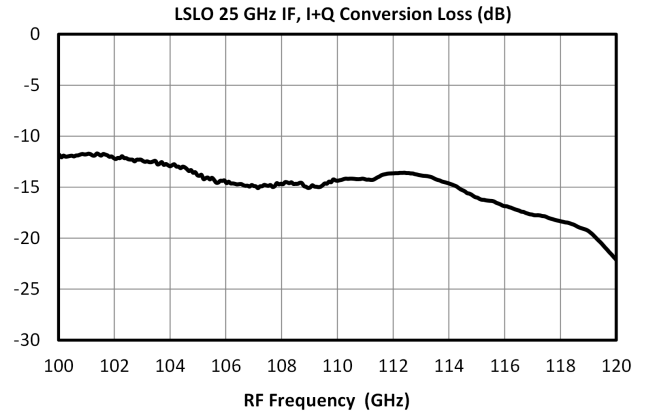
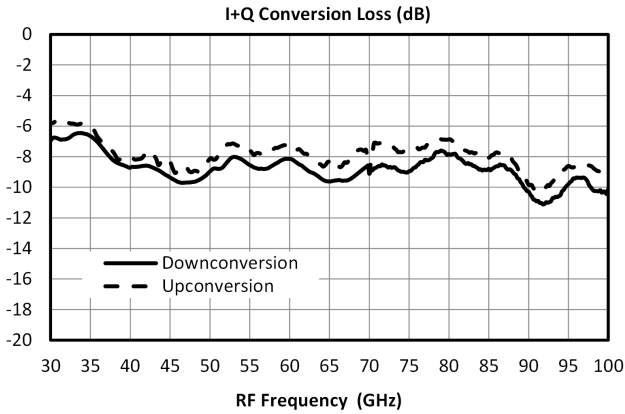

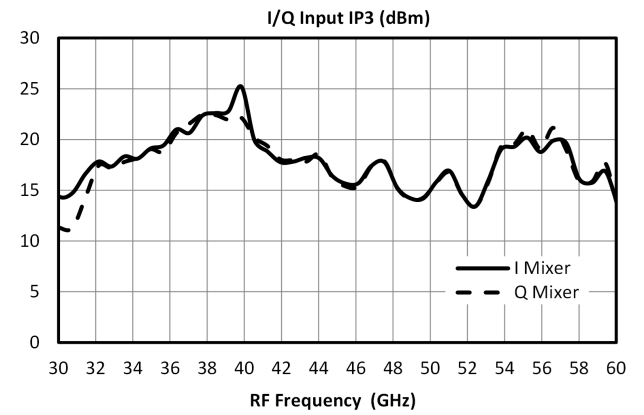
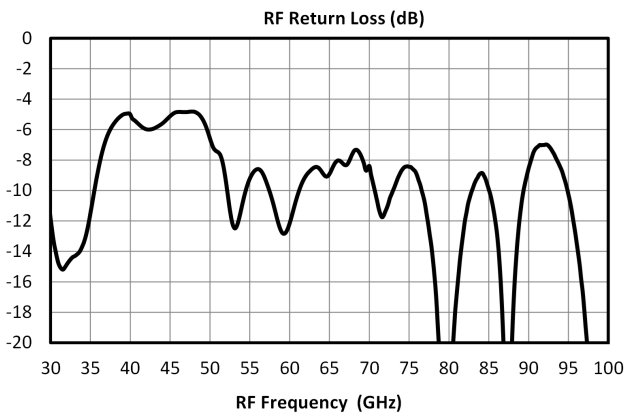
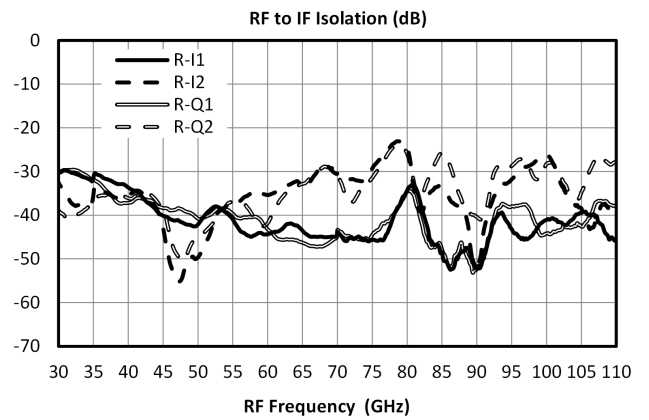
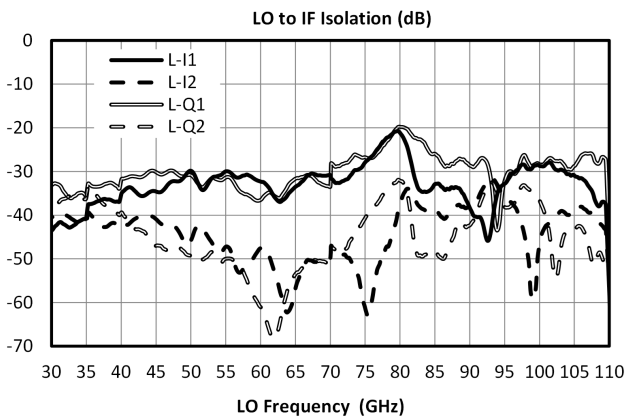
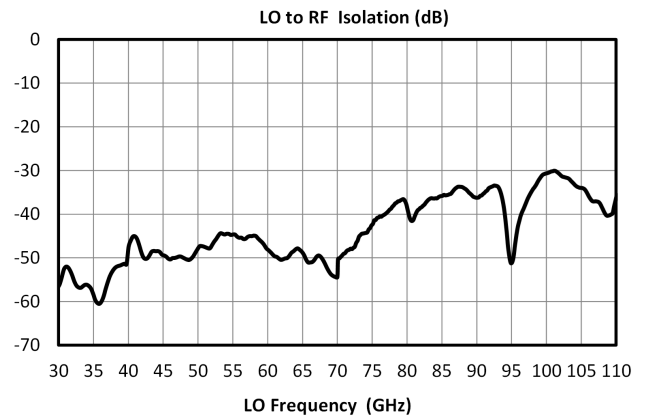
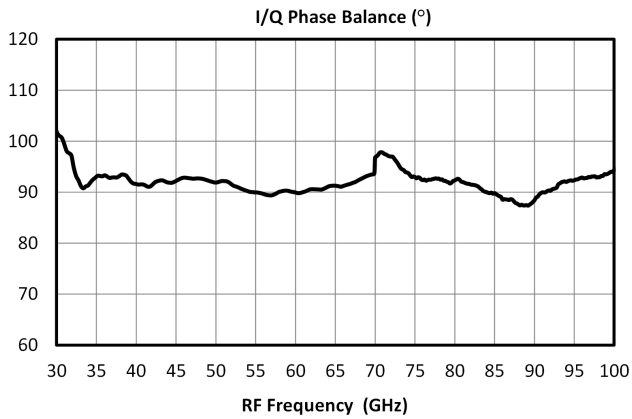
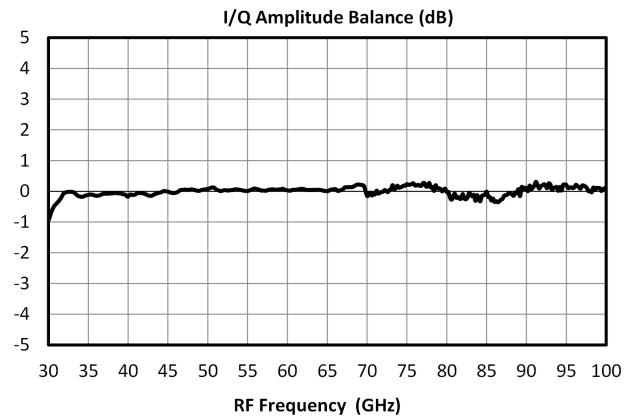
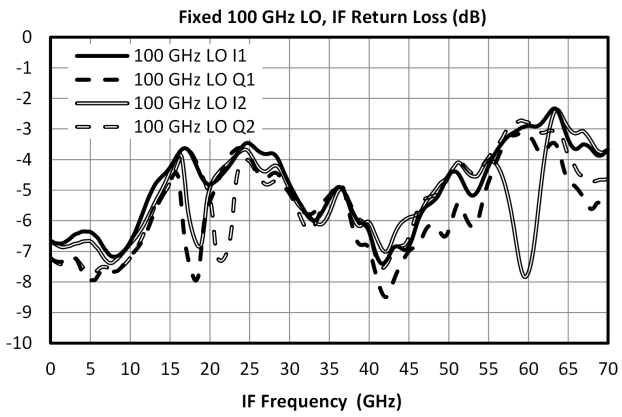

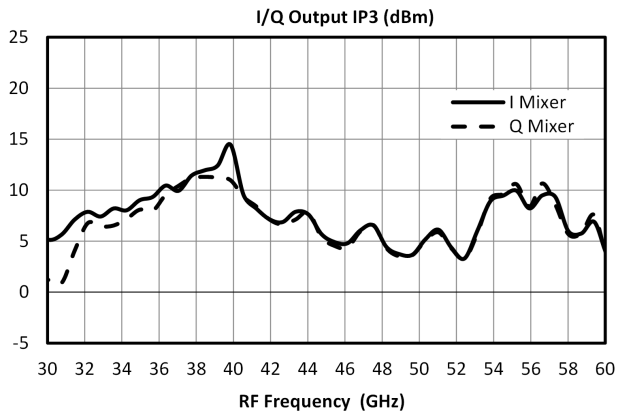

Application Information

Differential IF IQ Mixer Application

Single Ended Operation:

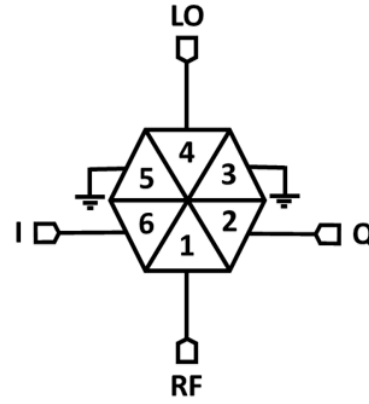
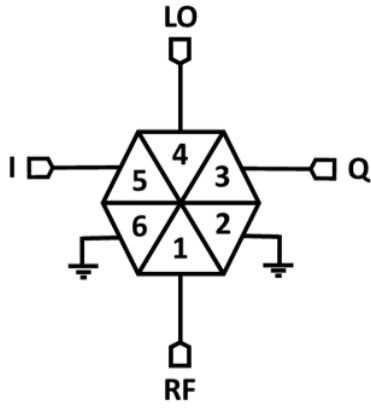

Choose one IF (I+ and Q+ or I- and Q-) and short the unused IF ports to ground

Single ended operation allows for use of a DC IF signal

Differential IF Operation:

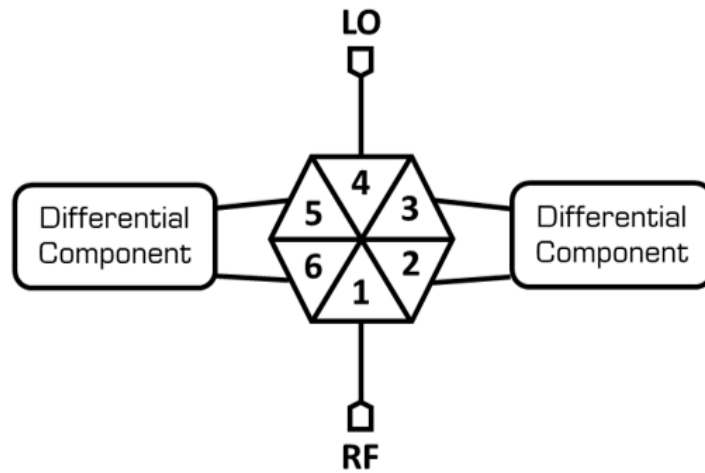

The mixer in its standard configuration is set up for use with differential IFs

Each IF port is 50Ω single ended/100Ω differential between I+/I- and Q+/Q-

Differential operation allows for common mode cancellation allowing one to run an ADC/DAC in differential mode

Application Circuit

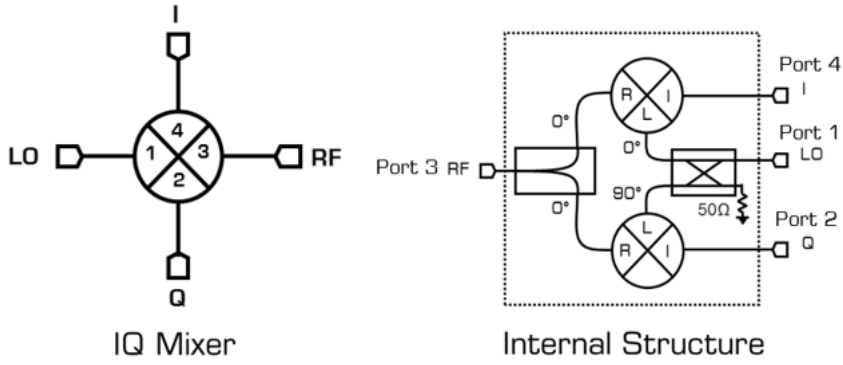

Application Circuit Description

The MMIQ-30120H belongs to Marki Microwave’s MMIQ family of mixers. The MMIQ product line consists of passive GaAs MMIC mixers designed and fabricated with GaAs Schottky diodes. MMIQ mixers offer excellent amplitude and phase balance due to its on-chip LO quadrature hybrid. Up to 27 dB of image rejection (i.e., single sideband suppression) can be obtained by using the MMIQ-30120H as an image rejection or single sideband mixer.

Support for the Ka through mmWave bands are offered by the ultra-broadband performance of the mixer’s RF and LO ports (ports 1 and 4). Traditional use of this mixer to do image reject or single sideband mixing is available with an external IF quadrature hybrid. The MMIQ-30120H is also suitable for use as a Vector Modulator through DC bias of the I and Q ports (one must configure the IQ mixer for DC IF operation as shown in section 4.1).

The RF port and the LO port support a 30-120 GHz signal. The I and Q ports support a DC-30 GHz signal. A signal may be input into any port of the mixer which supports that signal’s frequency. This is the basis of using the mixer as a band shifter.

For a given LO power within the recommended operating range, the RF (in the case of a down conversion) or IF (in the case of an up conversion) input power should be below the input 1 dB compression point to avoid signal distortion. The input 1 dB compression point will vary across the mixer’s operating bandwidth and with LO input power. Careful characterization is required for optimal performance for each application. There is no minimum small signal input power required for operation. Excessive RF/IF input power increases non-desired spurious output power and degrades the fundamental conversion loss. Excessive LO input power can also cause this effect. The table below describes how to use an IQ mixer and quad hybrid to select a single sideband.

Up Conversion		
Hybrid Port	Mixer Port	Sideband Selected
0	I	Lower Sideband
90	Q	
90	I	Upper Sideband
0	Q	
Down Conversion		
Hybrid Port	Mixer Port	Sideband Selected
0	I	Upper Sideband
90	Q	
90	I	Lower Sideband
0	Q	

Down-Converter

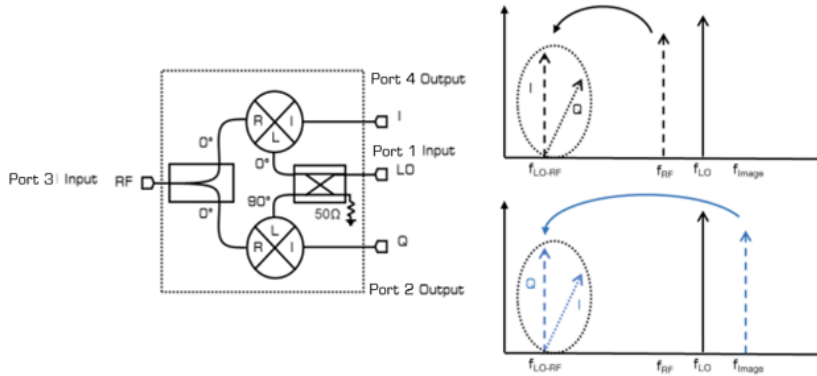

A down converter is a mixer application which takes a high frequency small signal RF input, and a high frequency large signal LO input and mixes the signals together to produce a low frequency IF output. The fundamental $1RF \times 1LO$ outputs present at the IF port are the f_{LO-RF} and f_{LO+RF} tones. The desired output in a down conversion is typically the f_{LO-RF} term. An image frequency at $f_{Image} = f_{2LO-RF}$ will also down convert to the f_{LO-RF} frequency. The above illustration shows the relative location of the image frequency for a highside LO, or the frequency plan for which $f_{LO} > f_{RF}$.

To use the IQ mixer as a down converter, input a high frequency small signal RF input, a high frequency large signal LO input, and pull the low frequency IF output. The IF ports will output the IF signals I and Q. I and Q IF outputs will be at the same frequency but 90° out of phase (i.e., I and Q are in quadrature). If only a single IF output is desired, terminate either the I or Q ports with a wideband 50Ω load.

Image Reject Down-Converter

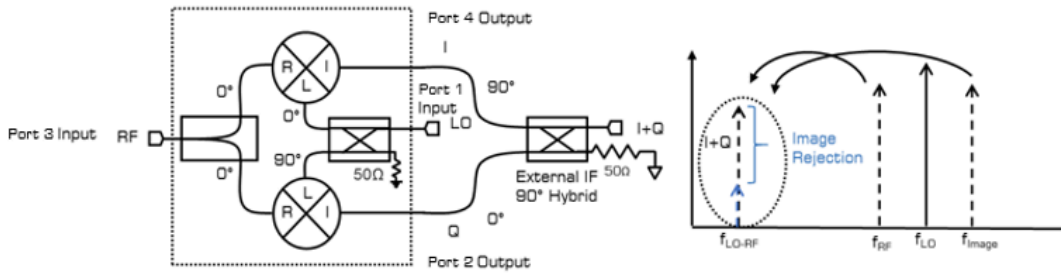

An image reject mixer is a mixer which rejects the down converted image frequency from the IF output. Image reject mixers are constructed using an external quadrature hybrid attached to the I and Q (i.e., IF) output ports. Using the external IF quadrature hybrid, one can select the whether the upper sideband or lower sideband signal is suppressed with respect to the LO signal.

To use the IQ mixer as an image reject mixer, input the high frequency small signal RF into and a high frequency large signal LO input into. Take the combined I+Q down converted signal through the IF quadrature hybrid. Select the upper sideband (i.e., suppress the lower sideband) by connecting the I port to the 0° port of the IF quadrature hybrid and attach the Q port to the 90° port of the IF quadrature hybrid. Select the lower sideband (i.e., suppress the upper sideband) by attaching the I port to the 90° port of the IF quadrature hybrid and attach the Q port to the 0° port of the IF quadrature hybrid.

Up-Converter

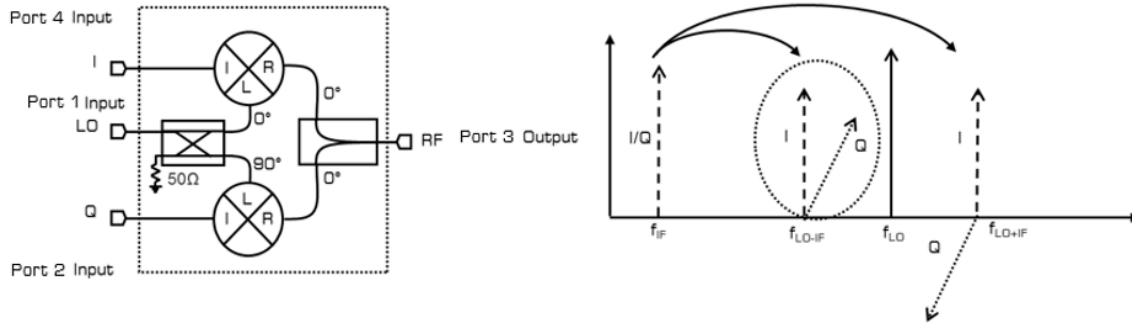

An up converter is a mixer application which takes a low frequency small signal IF input, and a high frequency large signal LO input and mixes the signal together to produce a high frequency RF output. The fundamental $1IF \times 1LO$ outputs present at the RF port are the f_{LO-IF} and f_{LO+RF} tones. An up conversion can select either the f_{LO-IF} or the f_{LO+IF} tones. The above illustration shows both up converted sidebands with either an I or Q port input signal.

To use the IQ mixer as an up converter, input a low frequency small signal IF input, a high frequency large signal LO input, and pull the high frequency RF output. Input into the Q port will result in a up converted signal that is 90° out of phase with the up converted I port input signal. If only a single IF input is desired, terminate either the I or Q ports with a wideband 50Ω load.

Single Sideband Up-Converter

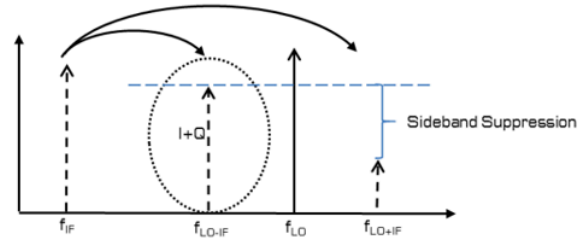
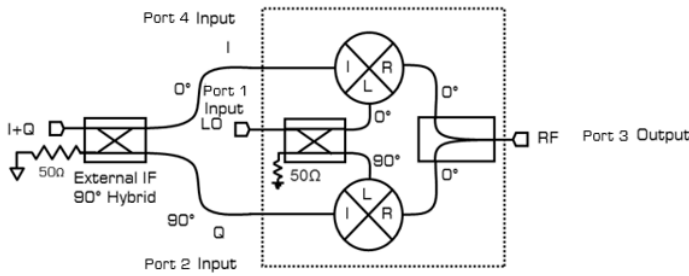

A single sideband mixer is a mixer which suppresses the up converted image frequency from the RF output. Single sideband mixers are constructed using an external quadrature hybrid attached to the I and Q (i.e., IF) input ports. Using an external IF quadrature hybrid, one can select whether the upper sideband of the lower sideband signal is suppressed with respect to the LO signal.

To use the IQ mixer as a single sideband mixer, input the low frequency small signal I+Q IF signal into the IF quadrature hybrid. The IF quadrature hybrid is attached to the I and Q ports of the IQ mixer. Input the high frequency large signal LO input and take the up converted high frequency RF signal. Select the upper sideband (i.e., suppress the lower sideband) by attaching the I port to the 90° port of the IF quadrature hybrid and attach the Q port to the 0° port of the IF quadrature hybrid. Select the lower sideband (i.e., suppress the upper sideband) by attaching the I port to the 0° port of the IF quadrature hybrid and attach the Q port to the 90° port of the IF quadrature hybrid.

Band Shifter

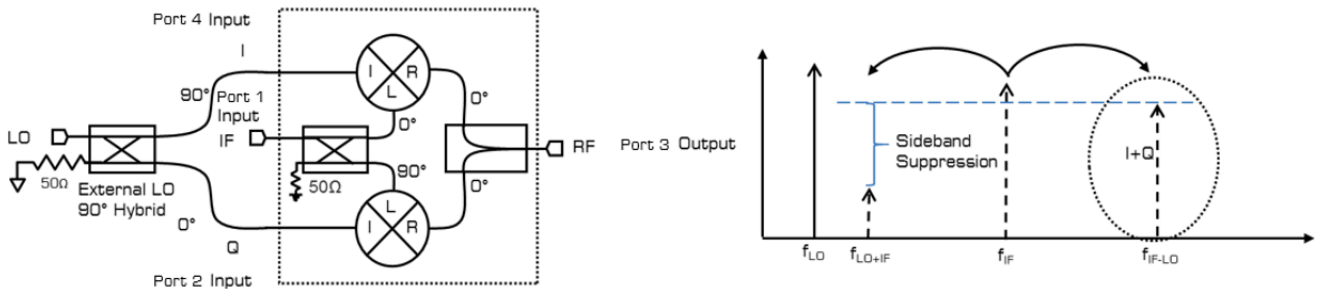

A band shifter is an unusual application for a mixer. Band shifters take an IF signal and shift it to a different band, generally to either avoid interference or for rebroadcast at a different frequency. For cases in which the desired band shift cannot be employed by using a standard up or down conversion scheme, an exotic input scheme is required.

A passive diode mixer is reciprocal on all ports. The RF port supports a 30-120GHz signal. Port 1, the LO port, supports a 30-120GHz signal. The IF ports support a DC-30GHz signal. 2 signals input into any combination of the RF, LO, or IF, will result in an output signal at the remaining port. In addition, an output signal will be present at both input ports. By using the IF port, as a large signal input port, low frequency LO applications can be supported.

The diagram above shows an IQ mixer being used as a band shifter. Using an IQ mixer as a band shifter allows for sideband suppression. This is identical to using the IQ mixer as a single sideband up converter. However, the large signal input port is now the IF ports versus LO. Selection of the output tone is done through the orientation of the LO quadrature hybrid.

To use the mixer as a single sideband band shifter, input a low frequency large signal LO into the external LO quadrature hybrid. Input the high frequency small signal IF signal and take the high frequency RF output. Select the upper sideband (i.e., suppress the lower sideband) by connecting the I port to the 90° port of the IF quadrature hybrid and connect the Q port to the 0° port of the LO quadrature hybrid. Select the lower sideband (i.e., suppress the upper sideband) by connecting the I port to the 0° port of the LO quadrature hybrid and connect the Q port to the 90° port of the LO quadrature hybrid.

Using this input scheme requires careful accounting of which input signal is injected which port. Injecting a signal into any port which does not support the correct band will lead to a degraded or no output response. Abide by the maximum DC current input into the I and Q ports of the mixer or otherwise irreversible damage to the mixer will occur.

The limiting factor in use of the mixer as an image reject band shifter is in the bandwidth of the external LO quadrature hybrid and bandwidth of the I and Q ports.

Vector Modulator

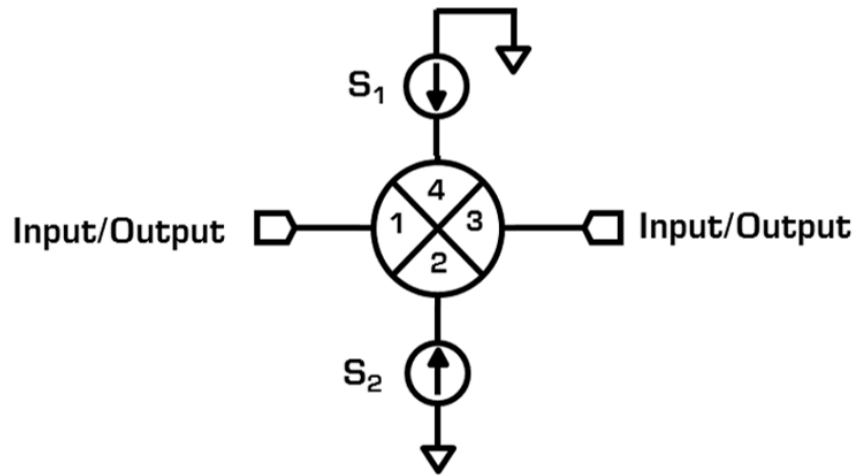

Mechanical Data

Outline Drawing

Download : [Outline 3D Drawing](#) | [Outline 3D STP](#)

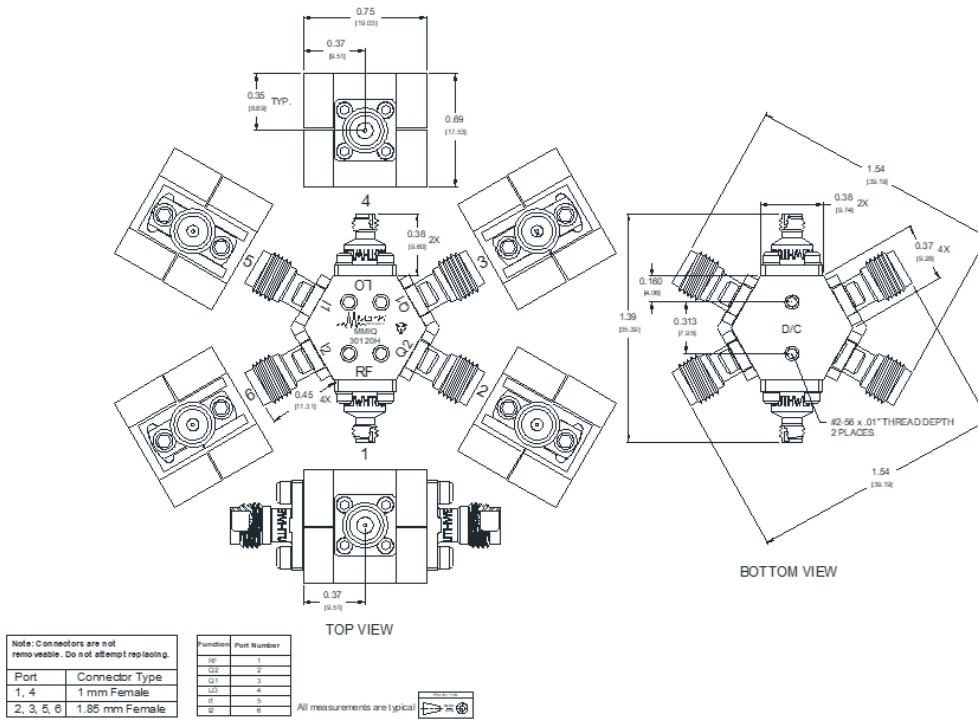

1. All measurements are typical.
2. Attach 1.0mm connectors with 45 N-cm (4 in-lb) torque wrench.

DISCLAIMER

MARKI MICROWAVE, INC., ("MARKI") PROVIDES TECHNICAL SPECIFICATIONS AND DATA (INCLUDING DATASHEETS), APPLICATION OR OTHER DESIGN ADVICE, WEB TOOLS, AND OTHER INFORMATION AND RESOURCES "AS IS" AND WITH ALL FAULTS. MARKI DISCLAIMS ALL WARRANTIES, EXPRESS OR IMPLIED, INCLUDING, WITHOUT LIMITATION, ANY IMPLIED WARRANTIES OF MERCHANTABILITY, FITNESS FOR A PARTICULAR PURPOSE, OR NON-INFRINGEMENT. These resources are intended for developers skilled in the art designing with Marki products. You are solely responsible for (1) selecting the appropriate products for your application, (2) designing, validating, and testing your application, and (3) ensuring your application meets applicable standards and other requirements. Marki makes no guarantee regarding the suitability of its products for any particular purpose, nor does Marki assume any liability whatsoever arising out of your use or application of any Marki product.

Marki grants you permission to use these resources only for development of an application that uses Marki products. Other reproduction or use of these resources is strictly prohibited. No license is granted to any other Marki intellectual property or to any third-party intellectual property. Marki reserves the right to make changes to the product(s) or information contained herein without notice.

MARKI MICROWAVE and T3 MIXER are trademarks or registered trademarks of Marki Microwave, Inc. All other trademarks used are the property of their respective owners.

© 2023, Marki Microwave, Inc