

MPD-0222SCSP2

2 - 22 GHz MMIC 2-Way Wilkinson Power Divider/Power Splitter, Side Ports

DEVICE OVERVIEW

General Description

The MPD-0222SCSP2 is a small footprint MMIC 2-22 GHz 2-Way power divider/power splitter featuring high 22 dB isolation and low 0.7 dB insertion loss in our compact 2.5 mm CSP2 chip scale package. It is much smaller than a printed PCB Wilkinson Power Divider/Combiner. It can be used as an equal amplitude/phase power splitter or a power combiner with excellent isolation. Tight fabrication tolerances result in less unit-to-unit variation than traditional power divider technologies, allowing for accurate simulations using the provided S3P file taken from measured production units. The MPD-0222SCSP2 features side port outputs. For front port outputs, refer to the MPD-0222FCSP2.



[Download s-parameters here](#)

Features

- 2-way splitter or combiner in a compact 2.5mm package
- Side ports
- Low 0.7 dB typical insertion loss
- High 22 dB isolation
- Excellent 0.04 dB amplitude and 0.6° phase balance
- This product embodies Marki Microwave's U.S. Pat. 11,869,858.

Applications

- Test Equipment
- Electronic Warfare
- Radar and satellite communications
- High Channel Count Systems

Functional Block Diagram

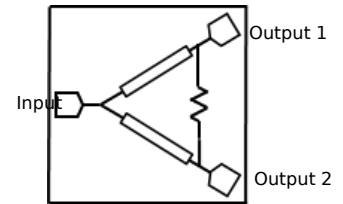

Part Ordering Options

Part Number	Description	Package	Green Status	Product Lifecycle	Export Classification
MPD-0222SCSP2	2 - 22 GHz MMIC 2-Way Wilkinson Power Divider/Power Splitter, Side Ports	CSP2	REACH RoHS	Released	EAR99
EVB-MPD-0222S	Evaluation Board, 2 - 22 GHz MMIC 2-Way Wilkinson Power Divider/Power Splitter, Side Ports	EVB	RoHS REACH	Released	EAR99

Table Of Contents

- **Device Overview**
 - General Description
 - Features
 - Applications
 - Functional Block Diagram
- **Port Configuration and Functions**
 - Port Diagram
 - Port Functions
- **Revision History**
- **Specifications**
 - Absolute Maximum Ratings
 - Package Information
 - Electrical Specifications
 - Typical Performance Plot
- **Mechanical Data**
 - Outline Drawing
- **Footprint Image**
- **Evaluation Board**
 - Evaluation Board Outline Drawing

Revision History

Revision Code	Revision Date	Comment
-	2025-08-13	Initial Release

MPD-0222SCSP2

2 - 22 GHz MMIC 2-Way Wilkinson Power Divider/Power Splitter, Side Ports

Port Configuration and Functions

Port Diagram

A bottom-up view of the MPD-0222SCSP2 package outline drawing is shown below. The MMIC Power dividers are passive reciprocal devices allowing either power splitting or power combining.

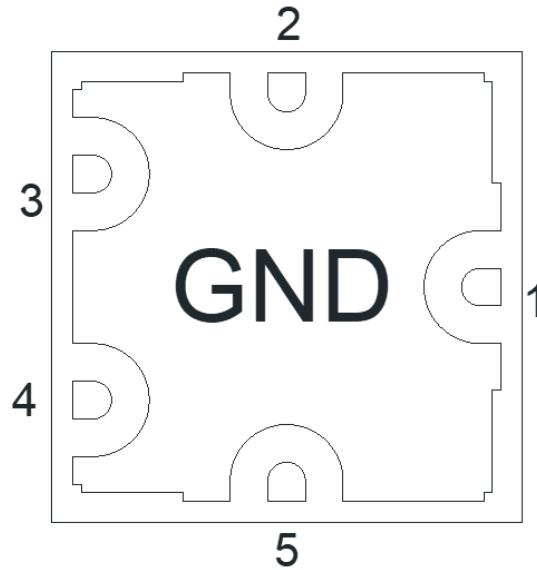

Port Functions

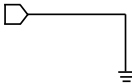
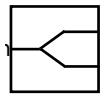
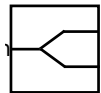
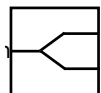
Port	Function	Description	DC Equivalent Circuit
Ground Paddle	Gnd	Ground paddle should be connected to RF ground	
Pin 1	Common	Pin 1 is the common input/output pin. It is DC open to Pin 2 and Pin 5 and short to ground.	
Pin 2	Input/Output 1	Pin 2 is an input/output pin. It is DC short to Pin 5 and open to Pin 1 and ground.	
Pin 5	Input/Output 2	Pin 5 is an input/output pin. It is DC short to Pin 2 and open to Pin 1 and ground.	

Specifications

Absolute Maximum Ratings

The Absolute Maximum Ratings indicate limits beyond which damage may occur to the device. If these limits are exceeded, the device may be inoperable or have a reduced lifetime.

Parameter	Maximum Rating	Unit
DC Current	40	mA
Maximum Operating Temperature	100	°C
Maximum Storage Temperature	125	°C
Minimum Operating Temperature	-55	°C
Minimum Storage Temperature	-65	°C
RF Power Handling, as a Divider ¹	10	W

^[1] Measured CW @ 22 GHz

Package Information

Parameter	Details	Rating
ESD	250 to < 500 Volts	HBM Class 1A
Dimensions	-	2.50 x 2.50 mm
Moisture Sensitivity Level	-	MSL 1

Electrical Specifications

The electrical specifications apply at TA=+25°C in a 50Ω system. Min and Max limits are guaranteed at TA=+25°C.

Parameter	Test Conditions	Minimum Frequency (GHz)	Maximum Frequency (GHz)	Min	Typ	Max	Unit
Amplitude Balance	-	2	22	-	0.04	-	dB
Common Return Loss	-	2	22	-	24	-	dB
Excess Insertion Loss ¹	-	2	22	-	0.72	-	dB
Impedance	-	2	22	-	50	-	Ω
Isolation	-	2	22	-	22	-	dB
Nominal Phase Shift	-	2	22	-	0	-	°
Nominal Power Splitting (dB)	-	2	22	-	3	-	dB
Output Return Loss	-	2	22	-	24	-	dB
Phase Balance	-	2	22	-	0.6	-	°

^[1] Excess Insertion Loss is loss in addition to power splitting loss, calculated as (Common Port to Output Port Insertion Loss) – (Power splitting loss of 3 dB)

Typical Performance Plot

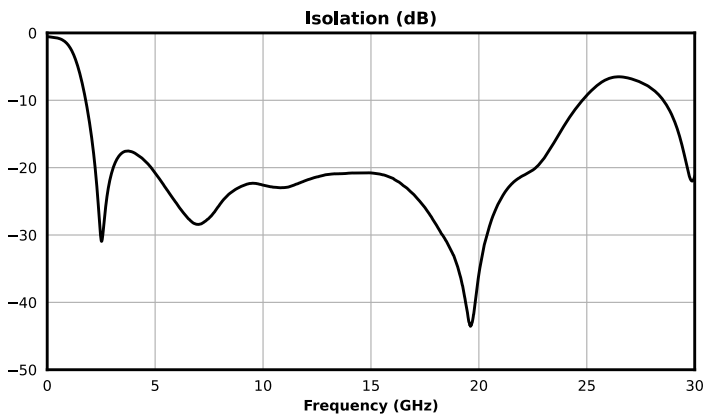
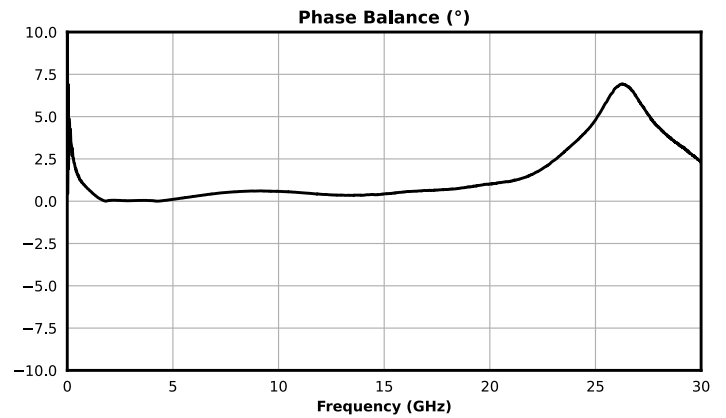
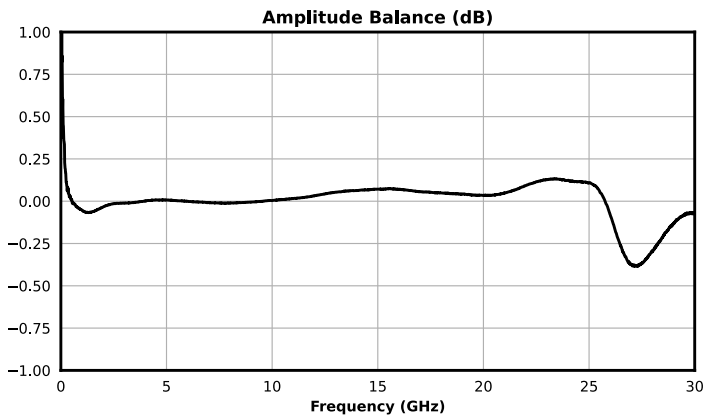
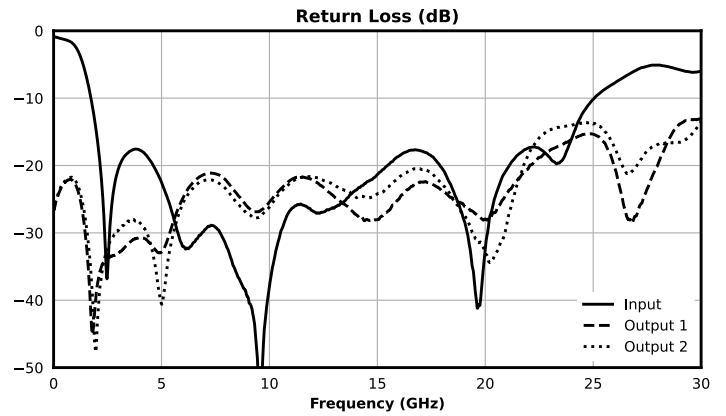
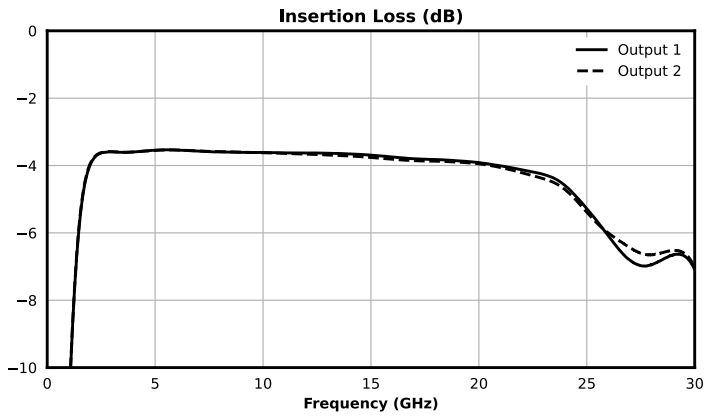

Measured data is de-embedded from fixture using automatic fixture removal (AFR).

Mechanical Data

Outline Drawing

Download : [Outline 2D Drawing](#) | [Outline 3D Drawing](#) | [Outline 3D STP](#)

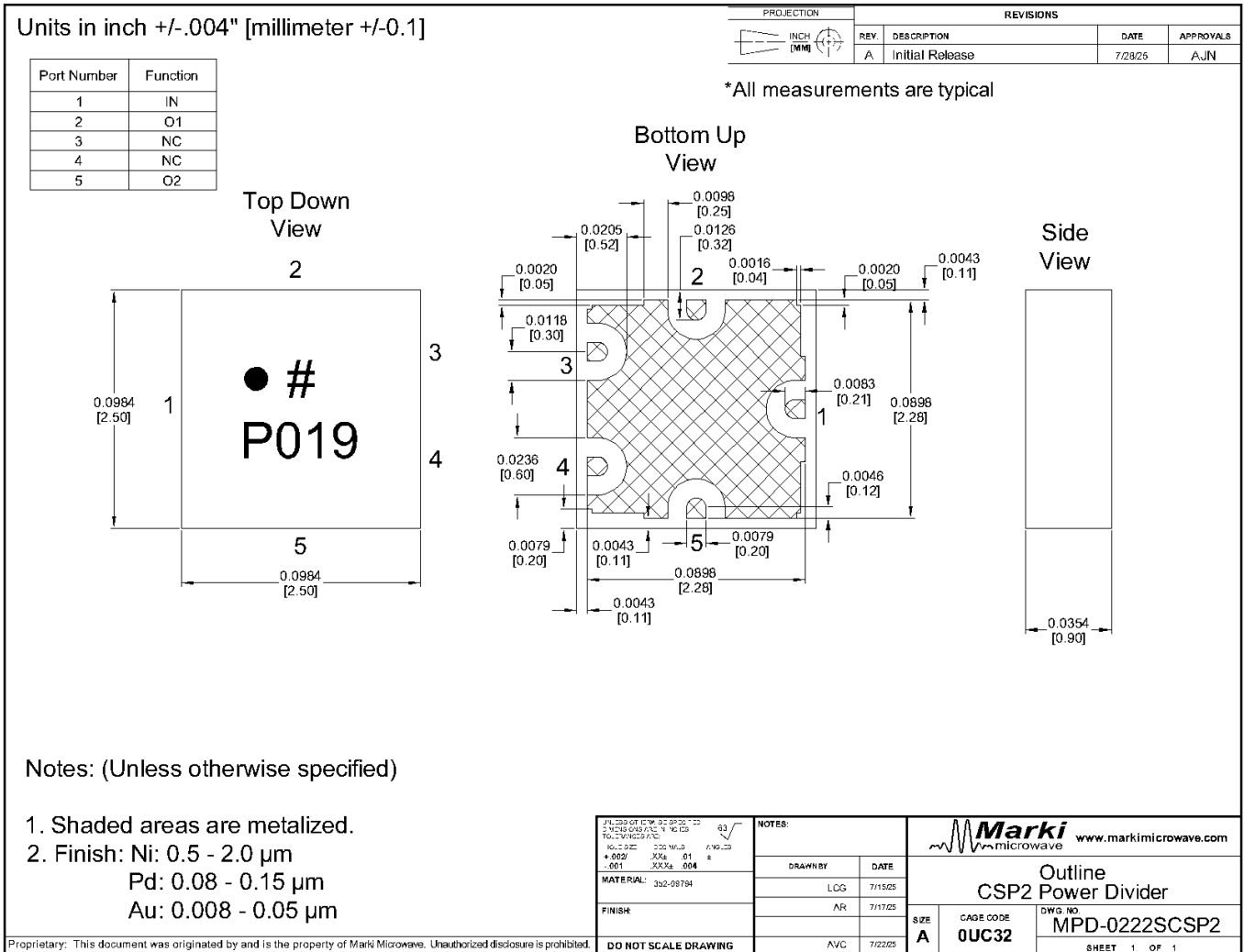

MPD-0222SCSP2

2 - 22 GHz MMIC 2-Way Wilkinson Power Divider/Power Splitter, Side Ports

Footprint Image

Download : [Footprint Drawing](#)

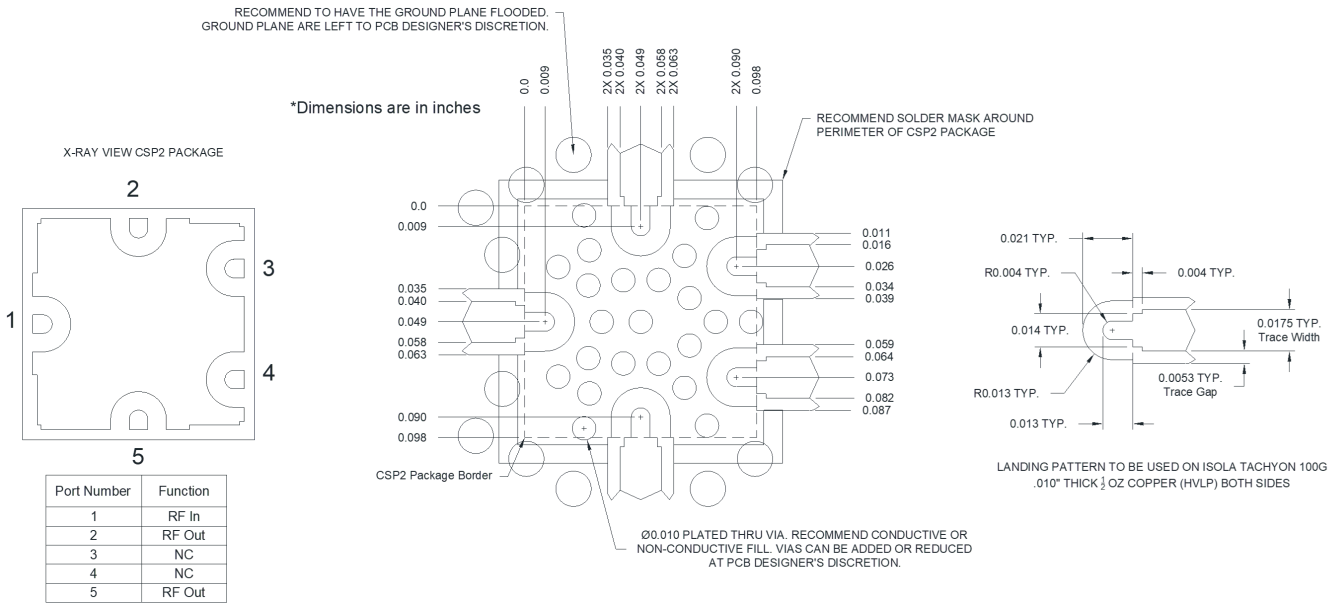

DISCLAIMER

MARKI MICROWAVE, LLC., ("MARKI") PROVIDES TECHNICAL SPECIFICATIONS AND DATA (INCLUDING DATASHEETS), APPLICATION OR OTHER DESIGN ADVICE, WEB TOOLS, AND OTHER INFORMATION AND RESOURCES "AS IS" AND WITH ALL FAULTS. MARKI DISCLAIMS ALL WARRANTIES, EXPRESS OR IMPLIED, INCLUDING, WITHOUT LIMITATION, ANY IMPLIED WARRANTIES OF MERCHANTABILITY, FITNESS FOR A PARTICULAR PURPOSE, OR NON-INFRINGEMENT.

These resources are intended for developers skilled in the art designing with Marki products. You are solely responsible for (1) selecting the appropriate products for your application, (2) designing, validating, and testing your application, and (3) ensuring your application meets applicable standards and other requirements. Marki makes no guarantee regarding the suitability of its products for any particular purpose, nor does Marki assume any liability whatsoever arising out of your use or application of any Marki product.

Marki grants you permission to use these resources only for development of an application that uses Marki products. Other reproduction or use of these resources is strictly prohibited. No license is granted to any other Marki intellectual property or to any third-party intellectual property. Marki reserves the right to make changes to the product(s) or information contained herein without notice.

MARKI MICROWAVE and T3 MIXER are trademarks or registered trademarks of Marki Microwave, LLC. All other trademarks used are the property of their respective owners.

© 2025, Marki Microwave, LLC