

ATN06-0067-3HV

GaAs MMIC DC to 67GHz Attenuator

DEVICE OVERVIEW

General Description

The ATN10-0067 is a family of precision GaAs MMIC fixed 6dB attenuators. These attenuators are an ideal solution for attenuating a signal and they can be used in a wide range of applications. They are ideal for test equipment’s protection and signal overload prevention in various RF circuitry. A 50-ohm match is maintained over the entire operating frequency range.



Features

- 6 dB attenuation DC to 67GHz
- Return loss: typical 22 dB over the entire band

Applications

- 5G
- Automotive Radar
- Test Equipment
- Amplitude Matching
- Precision Characterization
- Wireless Backhaul

Functional Block Diagram



Part Ordering Options

Part Number	Description	Package	Connectors	Green Status	Product Lifecycle	Export Classification
ATN06-0067-3HV	GaAs MMIC DC to 67GHz Attenuator	Module	<u>Standard</u>	RoHS REACH	Released	EAR99
ATN06-0067-2HV	GaAs MMIC DC to 67GHz Attenuator	Module	<u>Standard</u>	RoHS REACH	Released	EAR99
<u>ATN06-0067</u>	GaAs MMIC DC to 67GHz Attenuator	Module	<u>Standard</u>	RoHS REACH	Released	EAR99

Table Of Contents

- **Device Overview**
 - General Description
 - Features
 - Applications
 - Functional Block Diagram
- **Port Configuration and Functions**
 - Port Diagram
 - Port Functions
- **Revision History**
- **Specifications**
 - Absolute Maximum Ratings
 - Package Information
 - Electrical Specifications
 - Typical Performance Plots
 - Performance Over Temperature
 - Performance Over Current
- **Mechanical Data**
 - Outline Drawing

Revision History

Revision Code	Revision Date	Comment
-	2020-11-01	Datasheet Initial Release

Port Configuration and Functions

Port Diagram

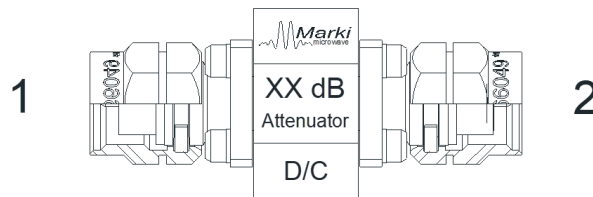

Port Functions

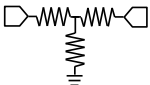
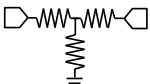
Port	Function	Connector Type	Description	Equivalent Circuit for Package
GND	Ground	-	Package ground provided through the metal housing and outer coax conductor.	
Port 1	Input/Output	1.85M	Port 1 and Port 2 are DC connected to each other and ground through a T-network of resistors.	
Port 2	Input/Output	1.85M	Port 1 and Port 2 are DC connected to each other and ground through a T-network of resistors.	

Specifications

Absolute Maximum Ratings

The Absolute Maximum Ratings indicate limits beyond which damage may occur to the device. If these limits are exceeded, the device may be inoperable or have a reduced lifetime.

Parameter	Maximum Rating	Unit
DC Current at any Port	100	mA
Maximum Operating Temperature	100	°C
Maximum Storage Temperature	125	°C
Minimum Operating Temperature	-55	°C
Minimum Storage Temperature	-65	°C
RF Power Handling	2	W

Package Information

Parameter	Details	Rating
ESD	250 to < 500 Volts	HBM Class 1A
Weight	Package name: Module	15.2g
Dimensions	-	14.30 x 32.45mm

Electrical Specifications

The electrical specifications apply at TA=+25°C in a 50Ω system. Typical data shown is for the attenuator with a sine wave input applied to port 1.

Parameter	Test Conditions	Minimum Frequency (GHz)	Maximum Frequency (GHz)	Min	Typ	Max	Unit
Attenuation	-	0	35	-	6.1	-	dB
Attenuation	-	35	67	-	6.4	-	dB
Attenuation Accuracy	-	35	67	-	0.4	-	dB
Attenuation Accuracy	-	0	35	-	0.2	-	dB
Return Loss	-	0	35	-	30	-	dB
Return Loss	-	35	67	-	23	-	dB

Typical Performance Plots

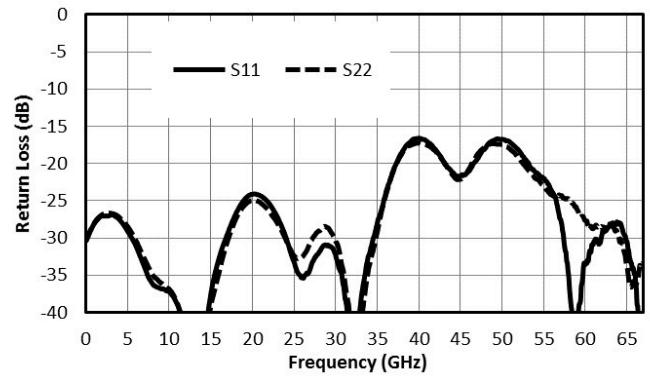
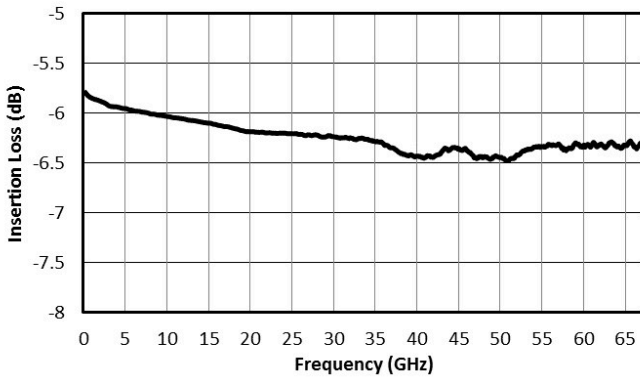

Performance Over Temperature

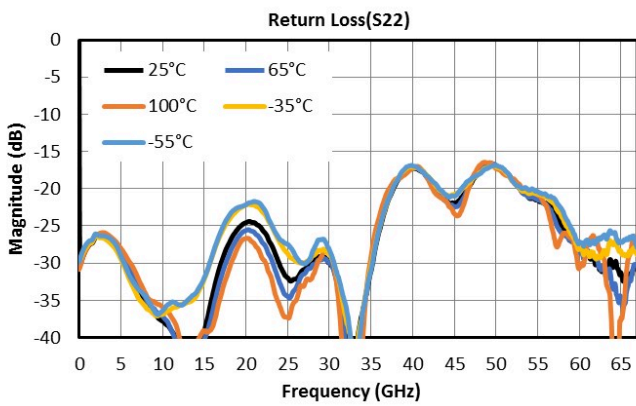
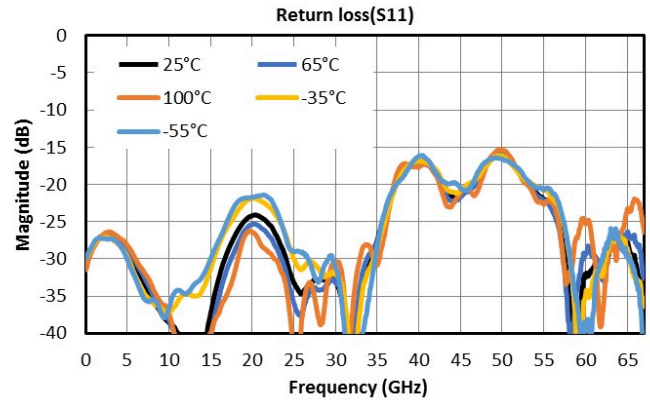
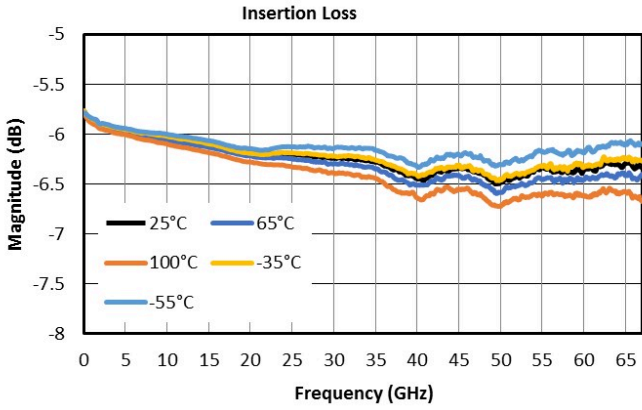

Performance Over Current

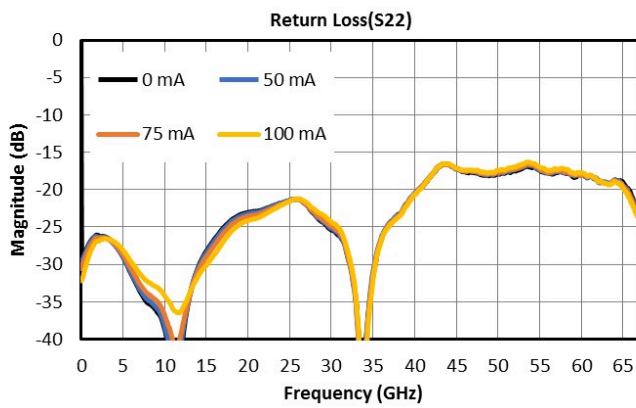
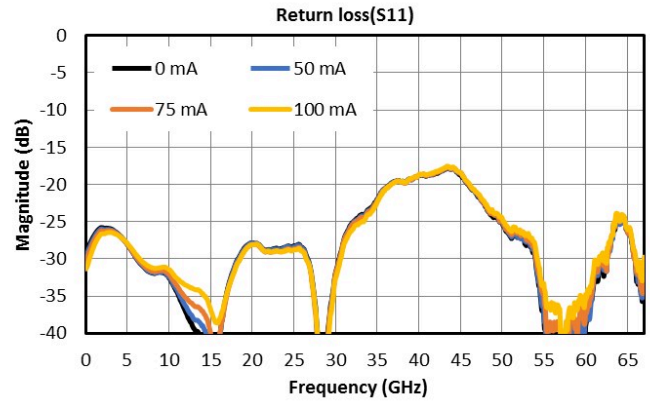
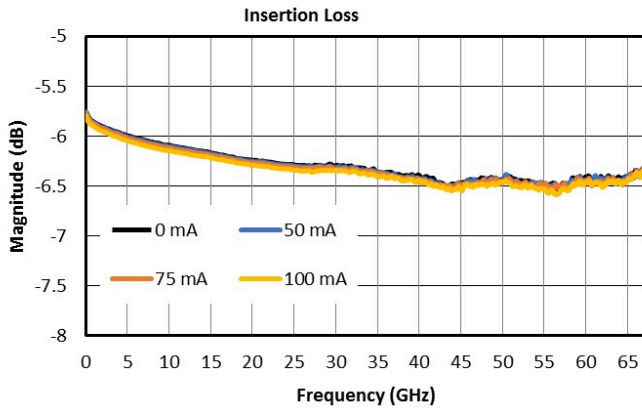

Mechanical Data

Outline Drawing

Download : [Outline 2D Drawing](#) | [Outline 3D Drawing](#) | [Outline 3D STP](#)

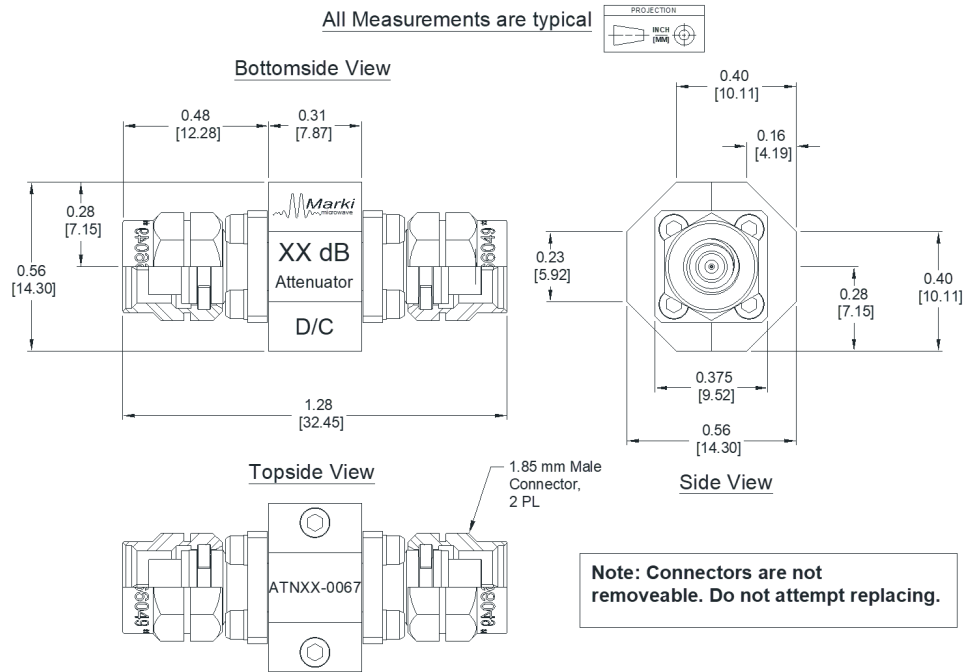

Note1: RoHS Compliant Assembly
 Note2: Use 9/16 fixed wrench to hold in place body of M housing while tightening connectors to 25Ncm

DISCLAIMER

MARKI MICROWAVE, INC., ("MARKI") PROVIDES TECHNICAL SPECIFICATIONS AND DATA (INCLUDING DATASHEETS), APPLICATION OR OTHER DESIGN ADVICE, WEB TOOLS, AND OTHER INFORMATION AND RESOURCES "AS IS" AND WITH ALL FAULTS. MARKI DISCLAIMS ALL WARRANTIES, EXPRESS OR IMPLIED, INCLUDING, WITHOUT LIMITATION, ANY IMPLIED WARRANTIES OF MERCHANTABILITY, FITNESS FOR A PARTICULAR PURPOSE, OR NON-INFRINGEMENT. These resources are intended for developers skilled in the art designing with Marki products. You are solely responsible for (1) selecting the appropriate products for your application, (2) designing, validating, and testing your application, and (3) ensuring your application meets applicable standards and other requirements. Marki makes no guarantee regarding the suitability of its products for any particular purpose, nor does Marki assume any liability whatsoever arising out of your use or application of any Marki product.

Marki grants you permission to use these resources only for development of an application that uses Marki products. Other reproduction or use of these resources is strictly prohibited. No license is granted to any other Marki intellectual property or to any third-party intellectual property. Marki reserves the right to make changes to the product(s) or information contained herein without notice.

MARKI MICROWAVE and T3 MIXER are trademarks or registered trademarks of Marki Microwave, Inc. All other trademarks used are the property of their respective owners.

© 2020, Marki Microwave, Inc