

MEQ3-7ASM

Passive GaAs MMIC 7GHz Equalizer

DEVICE OVERVIEW

General Description

The MEQ3-7ASM passive MMIC equalizer QFN is an ideal solution for compensating for low pass filtering effects in RF/microwave and high speed digital systems. They provide positive slope from DC to 7GHz with DC attenuation options between 3 and 12dB. The unique design offers superior return loss to competitors. GaAs MMIC technology provides consistent unit-to-unit performance in a small, low cost form factor.

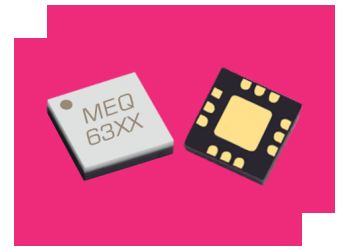

[Download s-parameters here](#)

Features

- DC attenuation options from 3 to 12dB
- Typical Insertion Loss 1.1dB at 7GHz
- VSWR < 1.5:1 Over Entire Band

Applications

- RF Transceivers
- High-Speed Data
- Telecom
- Cable Loss Compensation
- Amplifier Compensation

Functional Block Diagram



Part Ordering Options

Part Number	Description	Package	Green Status	Product Lifecycle	Export Classification
MEQ3-7ASM	Passive GaAs MMIC 7GHz Equalizer	QFN	REACH RoHS	Released	EAR99
<u>EVAL-MEQ3-7A</u>	Evaluation Board, Passive GaAs MMIC 7GHz Equalizer	EVAL	REACH RoHS	Released	EAR99

Table Of Contents

<ul style="list-style-type: none"> ■ Device Overview <ul style="list-style-type: none"> General Description Features Applications Functional Block Diagram ■ Port Configuration and Functions <ul style="list-style-type: none"> Port Diagram Port Functions ■ Revision History 	<ul style="list-style-type: none"> ■ Specifications <ul style="list-style-type: none"> Absolute Maximum Ratings Package Information Electrical Specifications Typical Performance Plots ■ Mechanical Data <ul style="list-style-type: none"> Outline Drawing ■ Footprint Image ■ Evaluation Board <ul style="list-style-type: none"> Evaluation Board Outline Drawing
---	--

Revision History

Revision Code	Revision Date	Comment
-	2018-05-01	Datasheet Initial Release
A	2018-08-01	Added EVAL Outline Section
B	2018-11-01	Updated EVAL Outline Section
C	2019-03-01	Updated ESD Rating
D	2019-05-01	Added Package Dimension Tolerance Spec
E	2019-08-01	Added SM Footprint

Port Configuration and Functions

Port Diagram

A top-down view of the MEQ3-7A CH package outline drawing is shown below. The MEQ equalizers are symmetrical allowing Port 1 or Port 2 to be used as the input.

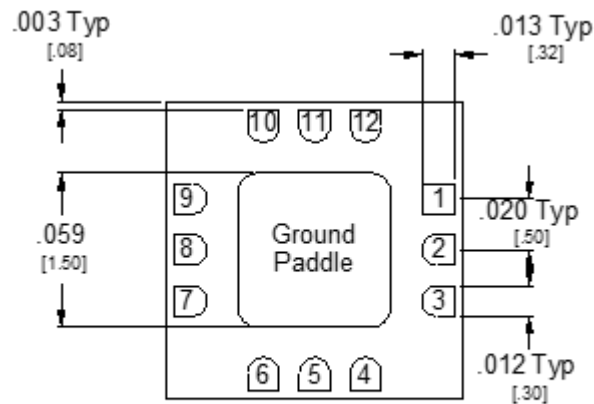

Port Functions

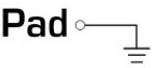
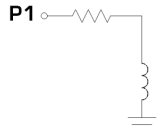
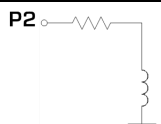
Port	Function	Description	DC Equivalent Circuit
GND	Ground	SM package ground path is provided through the ground paddle.	Pad 
Pin 1	RF Input / Output	Port 1 is DC connected to ground through a resistor. DC block is required if voltage present.	P1 
Pin 9	RF Input / Output	Port 2 is DC connected to ground through a resistor. DC block is required if voltage present.	P2 

Specifications

Absolute Maximum Ratings

The Absolute Maximum Ratings indicate limits beyond which damage may occur to the device. If these limits are exceeded, the device may be inoperable or have a reduced lifetime.

Parameter	Maximum Rating	Unit
Maximum Operating Temperature	100	°C
Maximum Storage Temperature	125	°C
Minimum Operating Temperature	-55	°C
Minimum Storage Temperature	-65	°C
Port 1 DC Current	40	mA
Port 2 DC Current	40	mA
Power Handling, at any Port	30	dBm

Package Information

Parameter	Details	Rating
ESD	250 to < 500 Volts	HBM Class 1A
Dimensions	-	3 x 3 mm
Moisture Sensitivity Level	-	MSL 1

Electrical Specifications

The electrical specifications apply at TA=+25°C in a 50Ω system. Typical data shown is for the equalizer in a CH package with a sine wave input applied to port 1. Min and Max limits are guaranteed at TA=+25°C. All bare die are 100% DC tested and visually inspected.

Parameter	Test Conditions	Minimum Frequency (GHz)	Maximum Frequency (GHz)	Min	Typ	Max	Unit
Insertion Loss	Freq=7GHz	7	7	-	1.1	-	dB
Insertion Loss at DC	Freq=0GHz	0	0	-	3	-	dB
Return Loss	Freq=0-7GHz	0	7	-	29	-	dB

Equalizer is symmetrical. Reverse measurement is equivalent to forward measurement. All measurements taken in eval board without de-embedding.

Typical Performance Plots

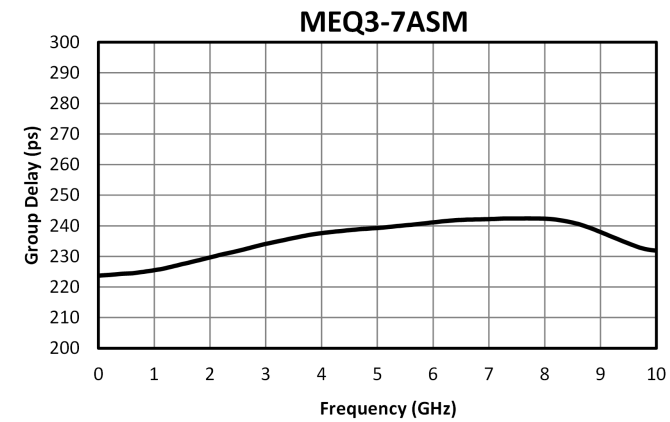
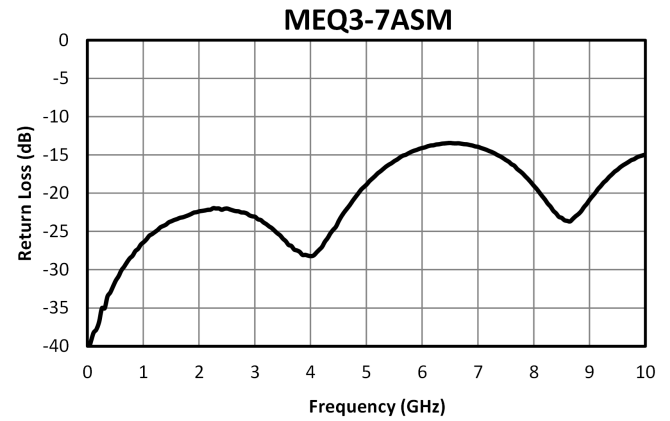
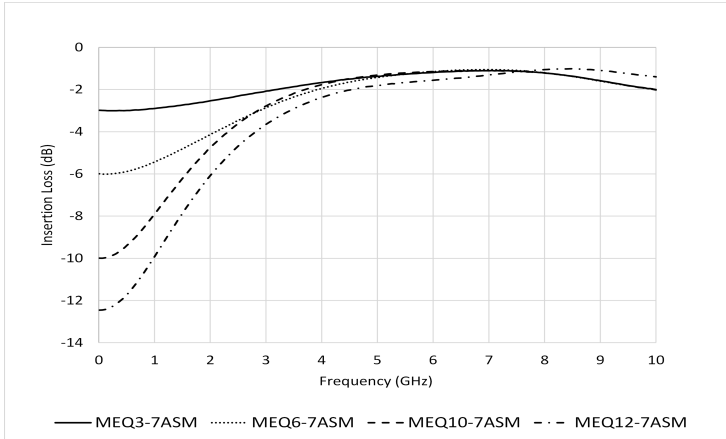

Mechanical Data

Outline Drawing

Download : [Outline 2D Drawing](#) | [Outline 3D Drawing](#) | [Outline 3D STP](#)

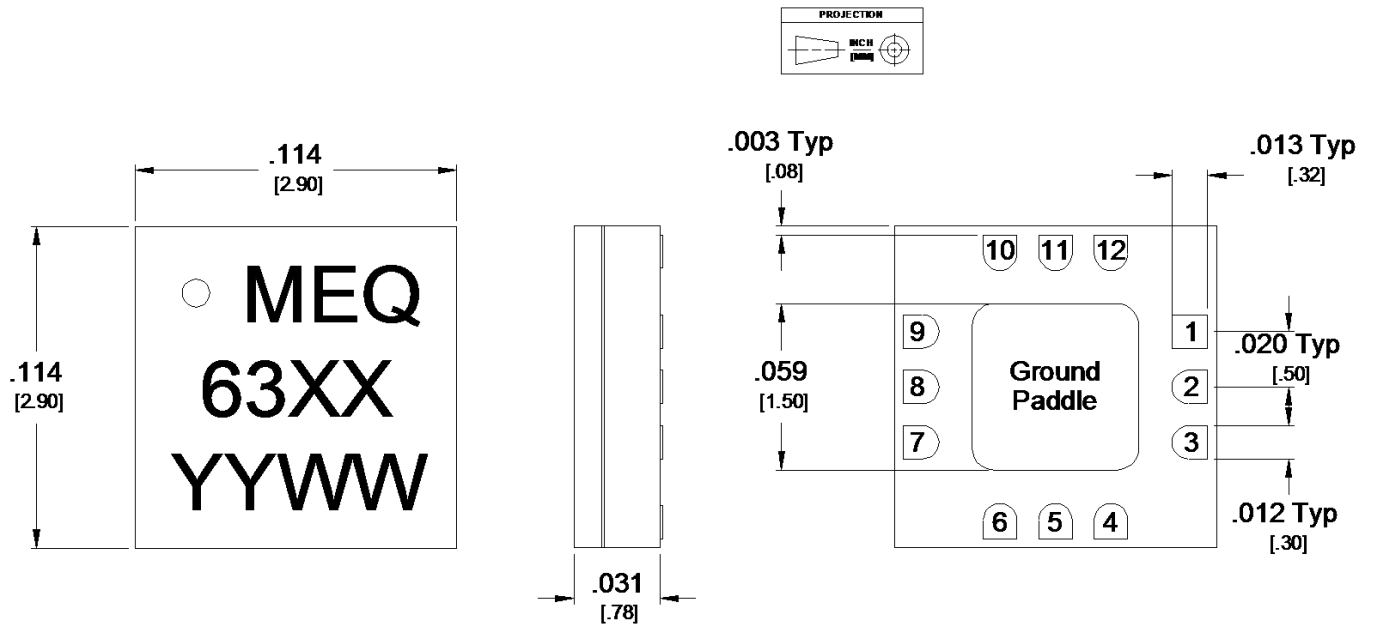

Footprint Image

Download : [Footprint Drawing](#)

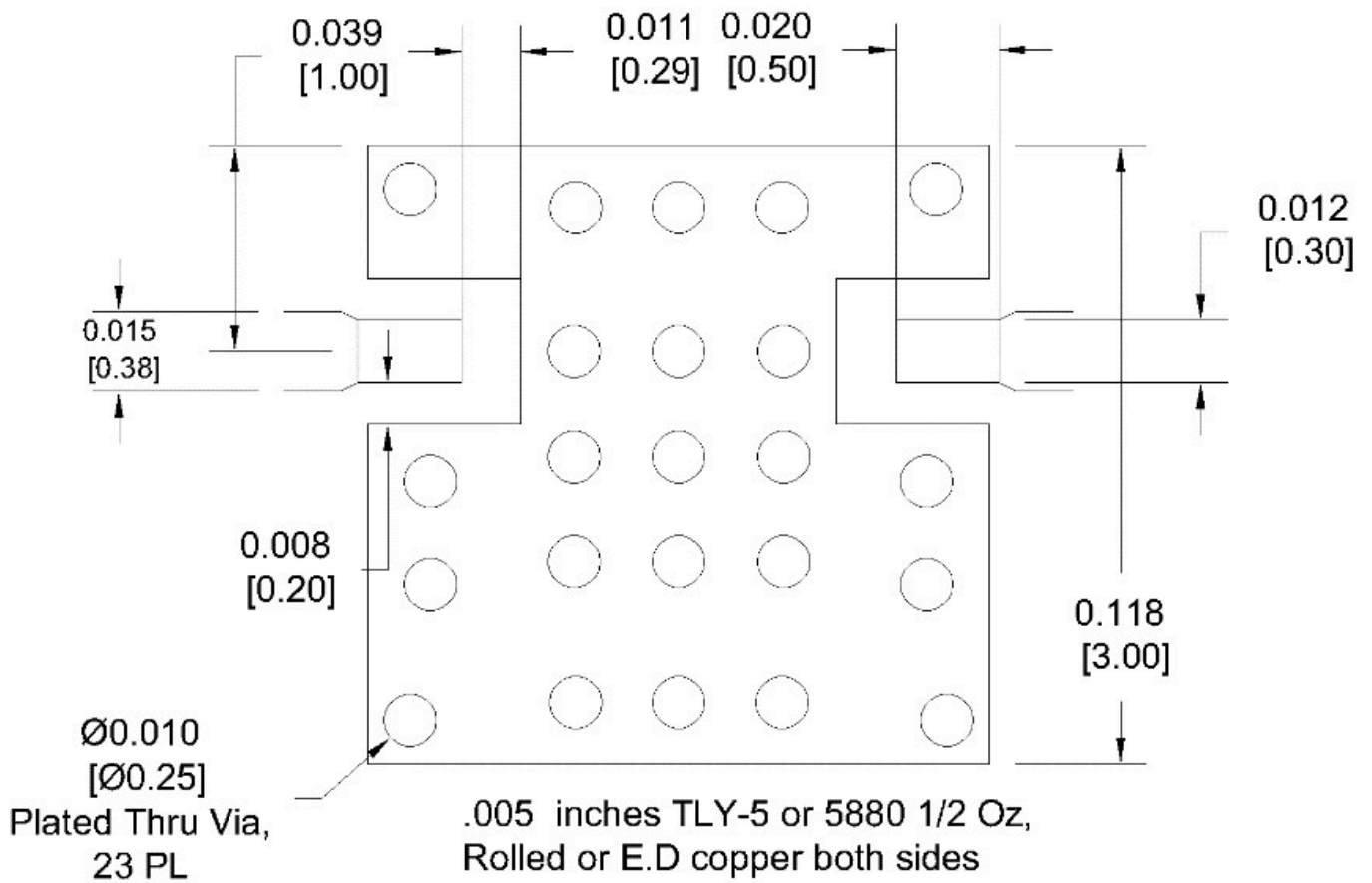

Evaluation Board - Outline Drawing

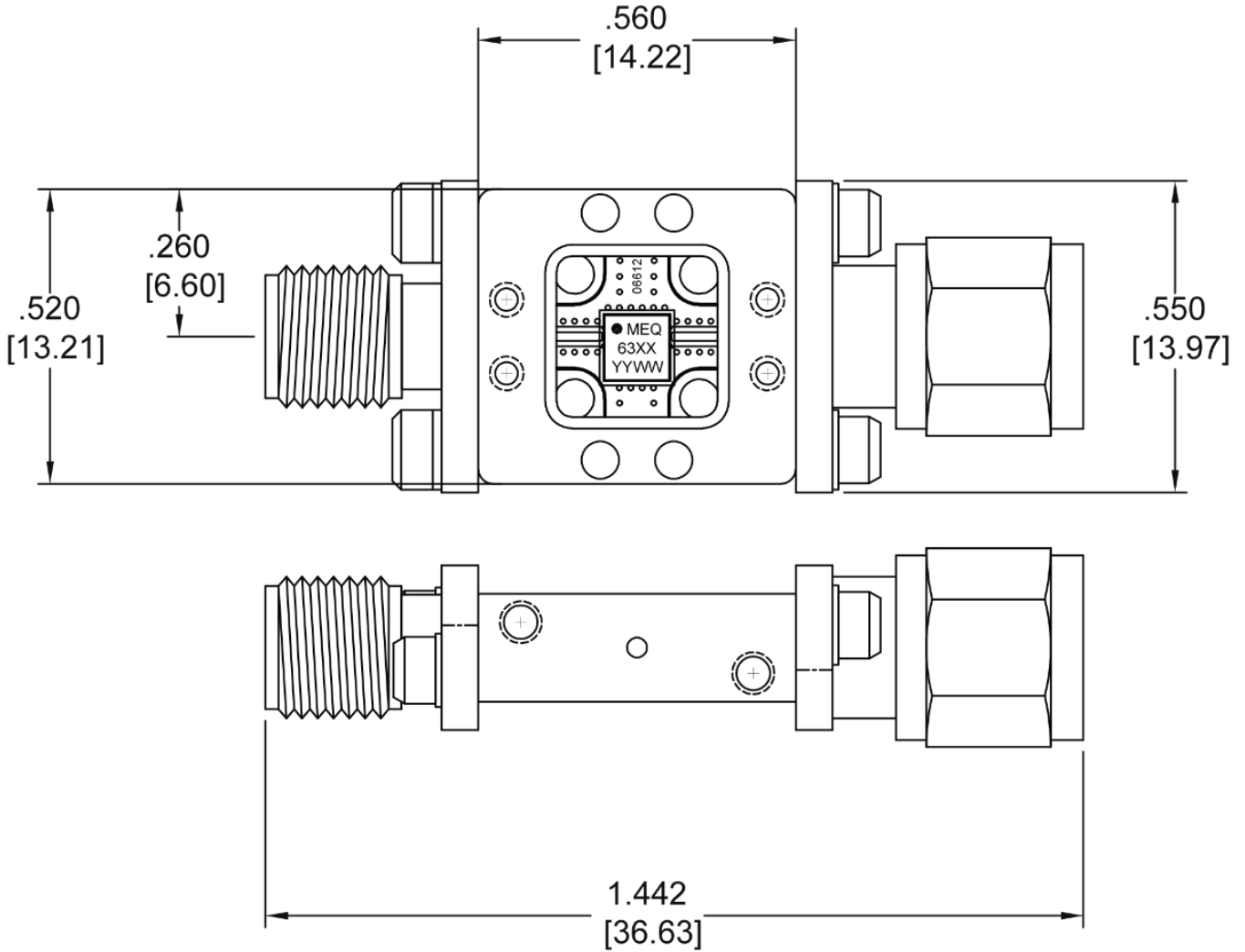

XX	Part Number
33	Eval-MEQ3-7A
34	Eval-MEQ6-7A
35	Eval-MEQ10-7A
44	Eval-MEQ12-7A

Port	Connector Type
I	SMA Female
O	SMA Male

Note: Eval-Package Connectors are not removeable.

DISCLAIMER

MARKI MICROWAVE, LLC., ("MARKI") PROVIDES TECHNICAL SPECIFICATIONS AND DATA (INCLUDING DATASHEETS), APPLICATION OR OTHER DESIGN ADVICE, WEB TOOLS, AND OTHER INFORMATION AND RESOURCES "AS IS" AND WITH ALL FAULTS. MARKI DISCLAIMS ALL WARRANTIES, EXPRESS OR IMPLIED, INCLUDING, WITHOUT LIMITATION, ANY IMPLIED WARRANTIES OF MERCHANTABILITY, FITNESS FOR A PARTICULAR PURPOSE, OR NON-INFRINGEMENT.

These resources are intended for developers skilled in the art designing with Marki products. You are solely responsible for (1) selecting the appropriate products for your application, (2) designing, validating, and testing your application, and (3) ensuring your application meets applicable standards and other requirements. Marki makes no guarantee regarding the suitability of its products for any particular purpose, nor does Marki assume any liability whatsoever arising out of your use or application of any Marki product.

Marki grants you permission to use these resources only for development of an application that uses Marki products. Other reproduction or use of these resources is strictly prohibited. No license is granted to any other Marki intellectual property or to any third-party intellectual property. Marki reserves the right to make changes to the product(s) or information contained herein without notice.

MARKI MICROWAVE and T3 MIXER are trademarks or registered trademarks of Marki Microwave, LLC. All other trademarks used are the property of their respective owners.

© 2018 - 2019, Marki Microwave, LLC