

# MMIQ-0218HXPC

## Passive GaAs MMIC IQ Mixer

### DEVICE OVERVIEW

#### General Description

MMIQ-0218H is a low LO drive, passive GaAs MMIC IQ mixer that operates across a 9:1 bandwidth. This is an ultra-broadband mixer spanning 2 to 18GHz on the RF and LO ports with an IF from DC to 3 GHz. Up to 40 dB of image rejection is available due to the excellent phase and amplitude balance of its on-chip LO quadrature hybrid. Both wire bondable die and connectorized modules are available.

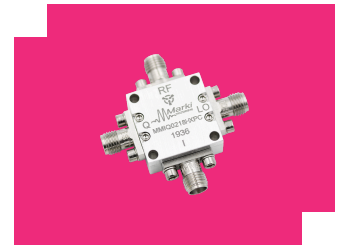

#### Features

N/A

#### Applications

- Single Sideband and Image Rejection Mixing
- IQ Modulation / Demodulation
- Band Shifting
- Vector Signal Modulation and Demodulation

#### Functional Block Diagram

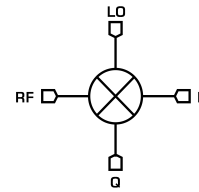

#### Part Ordering Options

Part Number	Description	Package	Connectors	Green Status	Product Lifecycle	Export Classification
MMIQ-0218HXPC	Passive GaAs MMIC IQ Mixer	XPC	<u>Standard</u>	REACH RoHS	Released	EAR99

## Table Of Contents

- **Device Overview**
  - General Description
  - Features
  - Applications
  - Functional Block Diagram
- **Port Configuration and Functions**
  - Port Diagram
  - Port Functions
- **Revision History**
- **Specifications**
  - Absolute Maximum Ratings
  - Package Information
  - Recommended Operating Conditions
  - Sequencing Requirements
  - Electrical Specifications
  - Typical Performance Plots
  - Typical Harmonic Performance
  - Typical Spurious Performance: Downconversion
  - Typical Spurious Performance: Up-Conversion
  - Spur Tables
- **Operation**
  - Application Circuit
  - Application Circuit Description
- **Mechanical Data**
  - Outline Drawing

## Revision History

Revision Code	Revision Date	Comment
-	2019-09-01	Datasheet Initial Release
A	2020-06-01	Added Spur Table

## Port Configuration and Functions

### Port Diagram

The mixer may be operated as either a downconverter or an upconverter. Use of the RF or IF as the input or output port will depend on the application. See Application Information for input and output port configuration for common applications.

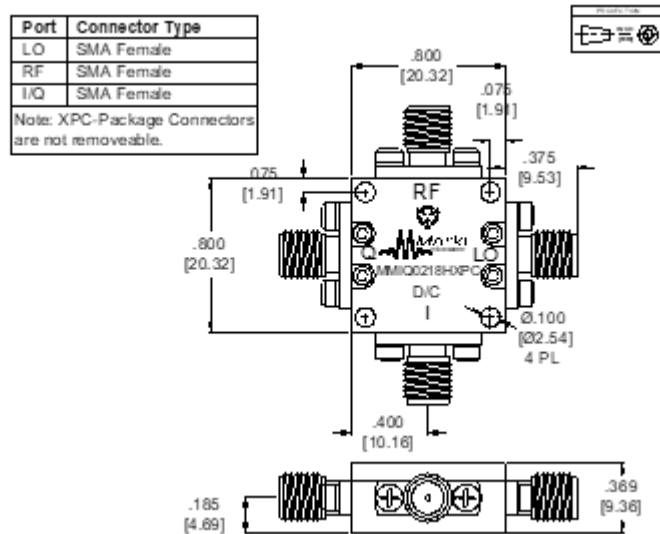

### Port Functions

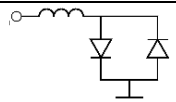
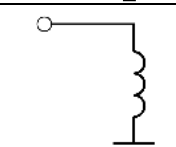
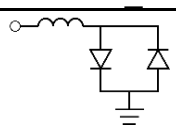
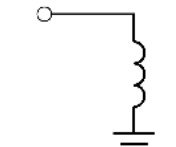
Port	Function	Connector Type	Description	Equivalent Circuit for Package
GND	Ground	-	XPC package ground taken through metal housing.	
I	I Input / Output	SMAF	I port is diode coupled and AC matched to 50Ω over the specified I port frequency range.	
LO	LO Input	SMAF	LO port is DC short and AC matched to 50Ω over the specified LO frequency range.	
Q	Q Input / Output	SMAF	Q port is diode coupled and AC matched to 50Ω over the specified Q port frequency range.	
RF	RF Input / Output	SMAF	RF port is DC short and AC matched to 50Ω over the specified RF frequency range.	

## Specifications

### Absolute Maximum Ratings

The Absolute Maximum Ratings indicate limits beyond which damage may occur to the device. If these limits are exceeded, the device may be inoperable or have a reduced lifetime.

Parameter	Maximum Rating	Unit
DC Current, at any Port	30	mA
Maximum Operating Temperature	100	°C
Maximum Storage Temperature	125	°C
Minimum Operating Temperature	-55	°C
Minimum Storage Temperature	-65	°C
Power Handling, at any Port	30	dBm

### Package Information

Parameter	Details	Rating
ESD	250 to < 500 Volts	HBM Class 1A
Dimensions	-	20.32 x 20.32 mm

### Recommended Operating Conditions

The Recommended Operating Conditions indicate the limits, inside which the device should be operated, to guarantee the performance given in Electrical Specifications. Operating outside these limits may not necessarily cause damage to the device, but the performance may degrade outside the limits of the electrical specifications. For limits, above which damage may occur, see Absolute Maximum Ratings.

Parameter	Min	Nominal	Max	Unit
LO Input Power	20	23	26	-
RF/IF Input Power	-	-	5	dBm
Ambient Temperature	-55	25	100	°C

### Sequencing Requirements

There is no requirement to apply power to the ports in a specific order. However, it is recommended to provide a 50Ω termination to each port before applying power. This is a passive diode mixer that requires no DC bias.

## Electrical Specifications

The electrical specifications apply at TA=+25°C in a 50Ω system. Typical data shown is for a down conversion application with a +23 dBm sine wave LO input. Min and Max limits apply only to our connectorized units and are guaranteed at TA=+25°C. All bare die are 100% DC tested and visually inspected.

Parameter	Test Conditions	Minimum Frequency (GHz)	Maximum Frequency (GHz)	Min	Typ	Max	Unit
Amplitude Balance	RF/LO = 2 - 18 GHz I/Q = 0.091 GHz	2	18	-	0.6	-	dB
Conversion Loss	RF/LO = 2 - 18 GHz I/Q = 0.2 - 3 GHz	2	18	-	11	15	dB
Conversion Loss	RF/LO = 2 - 18 GHz I/Q = DC - 0.2 GHz	2	18	-	10.5	13	dB
Image Rejection	RF/LO = 2 - 18 GHz IF = 0.091 GHz	2	18	-	35	-	dBc
Image Reject/Single Sideband Conversion Loss	RF/LO = 2 - 18 GHz IF = 0.091 GHz	2	18	-	7.5	11	dB
Input 1 dB Gain Compression Point, Combined Upconversion	RF/LO = 2 - 18 GHz IF = 0.091 GHz	2	18	-	13	-	dBm
Input 1 dB Gain Compression Point, Downconversion	RF/LO = 2 - 18 GHz I/Q/IF = 0.091 GHz	2	18	-	13	-	dBm
Input 1 dB Gain Compression Point, I/Q Upconversion	RF/LO = 2 - 18 GHz I/Q = 0.091 GHz	2	18	-	10	-	dBm
Input IP3	RF/LO = 2 - 18 GHz I = 0.091 GHz	2	18	-	22	-	dBm
Input IP3	RF/LO = 2 - 18 GHz IF = 0.091 GHz	2	18	-	25	-	dBm
Input IP3	RF/LO = 2 - 18 GHz IF = 0.091 GHz	2	18	-	25	-	dBm
Input IP3	RF/LO = 2 - 18 GHz I/Q = 0.091 GHz	2	18	-	21	-	dBm
Isolation, LO to IF	IF/LO = 2 - 18 GHz	2	18	-	26	-	dB
Isolation, LO to RF	RF/LO = 2 - 18 GHz	2	18	-	53	-	dB
Isolation, RF to IF	RF/IF = 2 - 18 GHz	2	18	-	36	-	dB
LO Frequency Range	-	-	-	2	-	18	GHz
Noise Figure <sup>1</sup>	RF/LO = 2 - 18 GHz I/Q = DC - 0.2 GHz	2	18	-	10.5	-	dB
Phase Balance	RF/LO = 2 - 18 GHz IF = 0.091 GHz	2	18	-	6	-	°
Q Port Frequency Range	-	-	-	0	-	3	GHz
RF Frequency Range	-	-	-	2	-	18	GHz
IF Frequency Range	-	-	-	0	-	3	GHz

<sup>[1]</sup> Image Rejection and Single sideband performance plots are defined by the upper sideband (USB) or lower sideband (LSB) with respect to the LO signal. Plots are defined by which sideband is selected by the external IF quadrature hybrid.

### Typical Performance Plots

The test conditions and frequency plan below applies to all following sections, unless otherwise specified.

Parameter	Port	Start	Nominal	Stop	Units
RF Input Frequency	RF	0		20	GHz
RF Input Power			-10		dBm
LO Input Frequency	LO	0.091		20.091	GHz
LO Input Power			+23		dBm
IF Output Frequency	I		91		MHz
	Q				
	I+Q <sup>4</sup>				
T <sub>A</sub> , Ambient Temperature			+25		°C
Z <sub>0</sub> , System Impedance			50		Ω

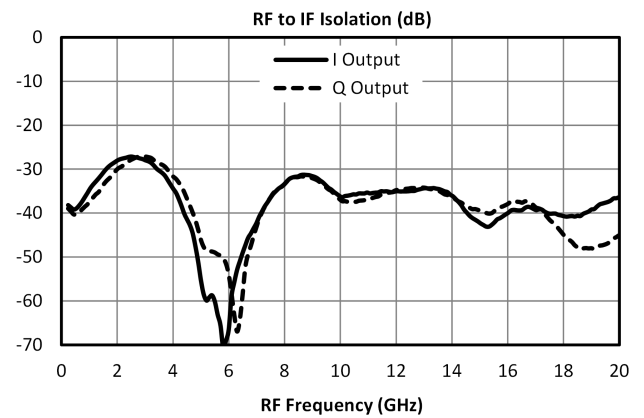
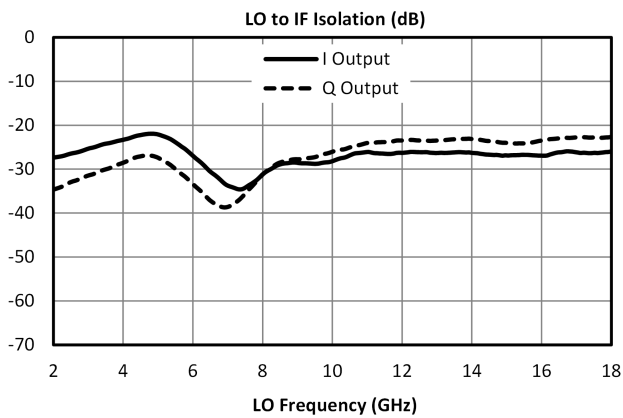
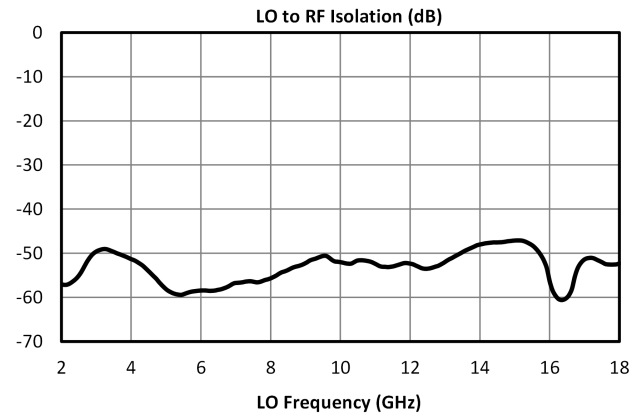
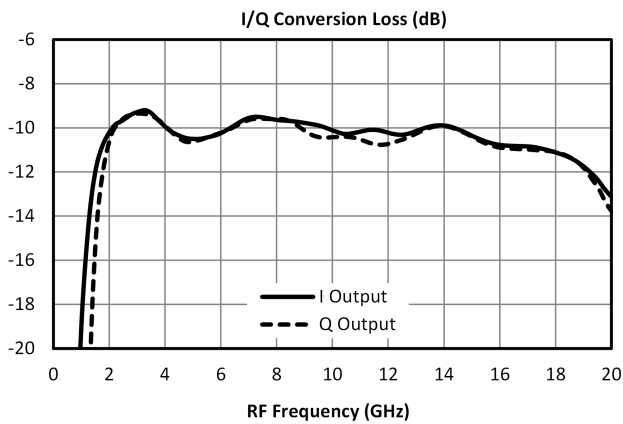

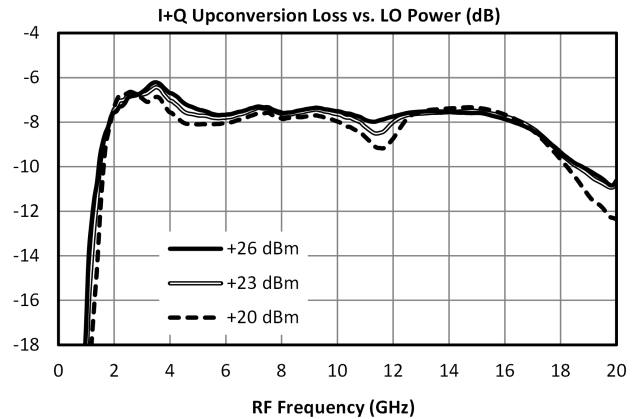
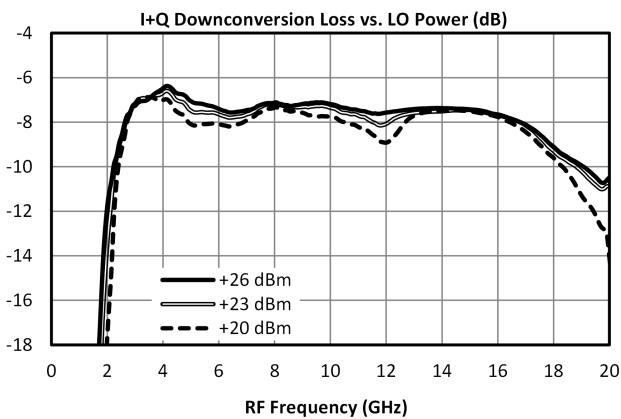
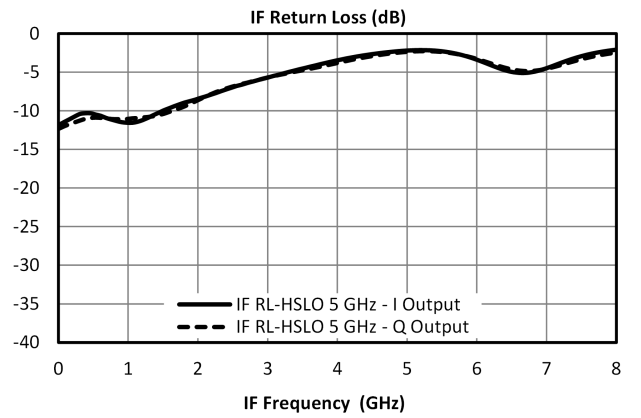
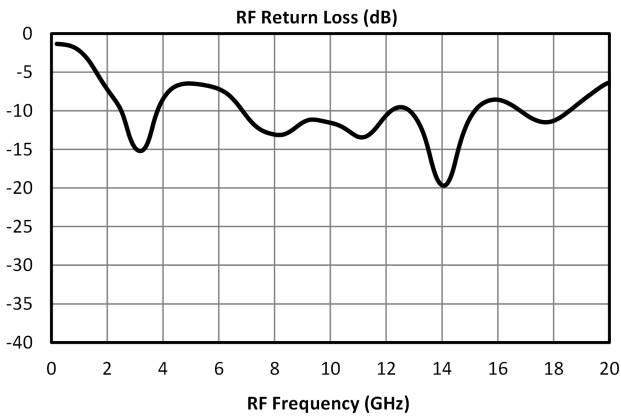
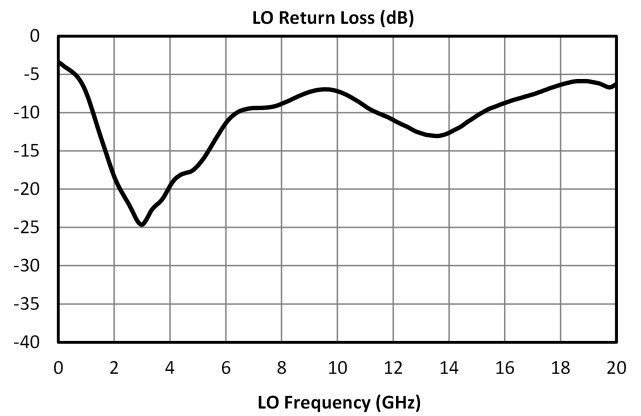
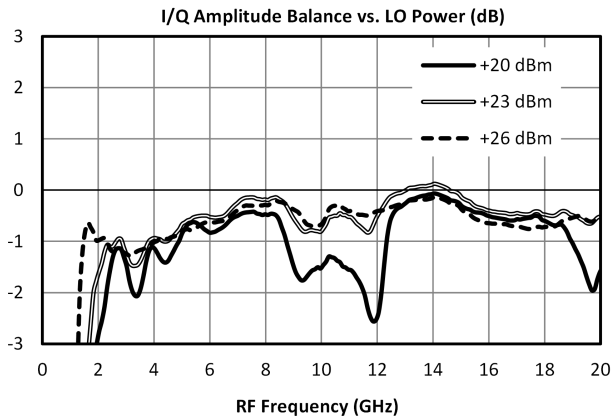
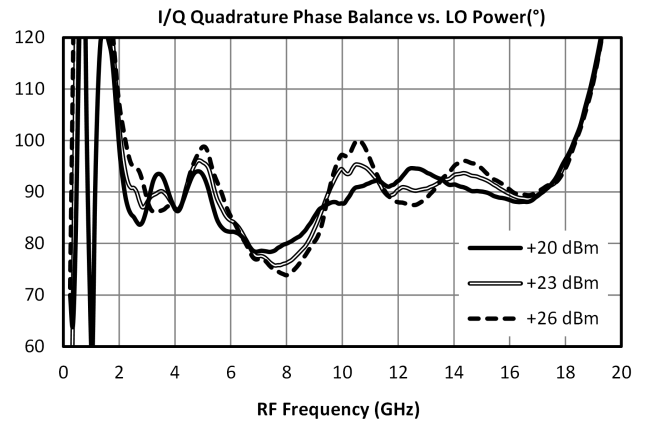
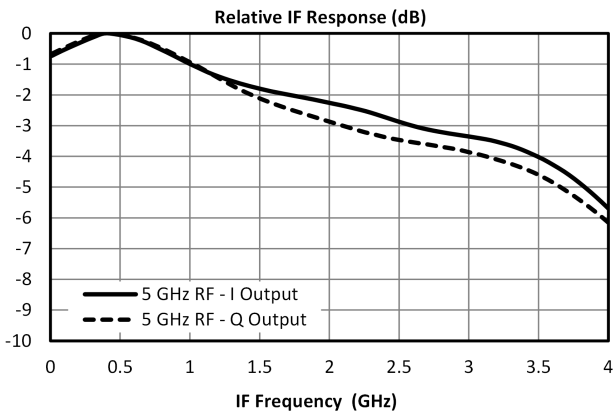

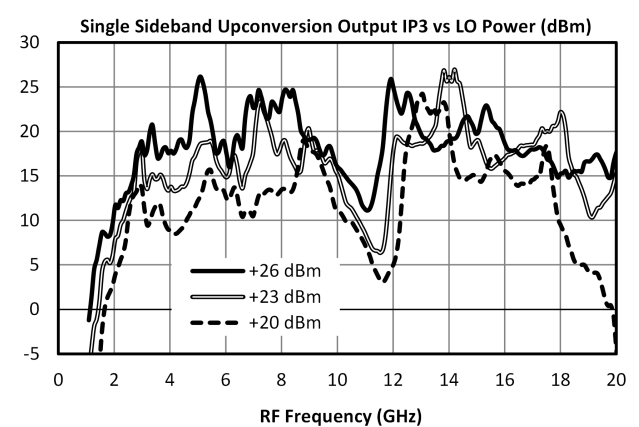
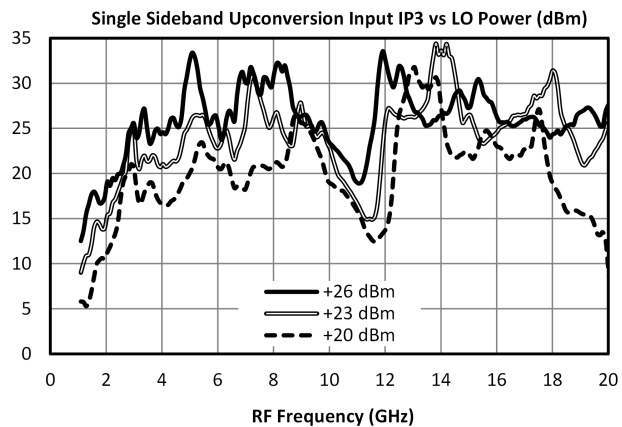
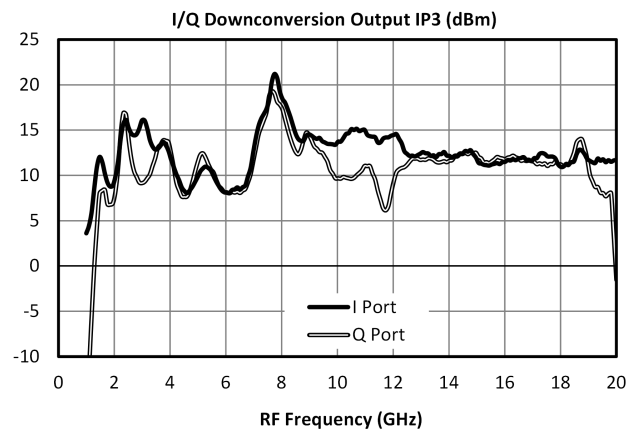
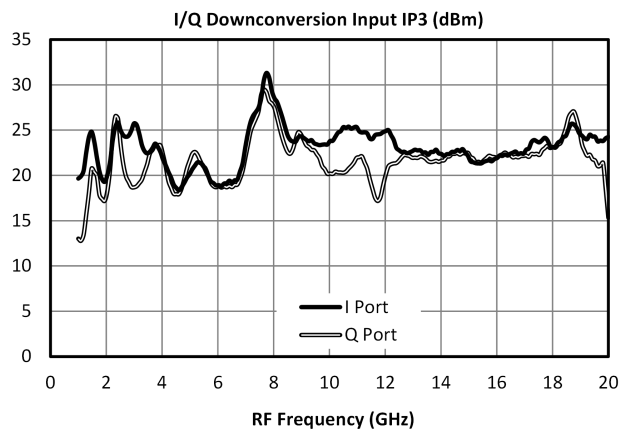
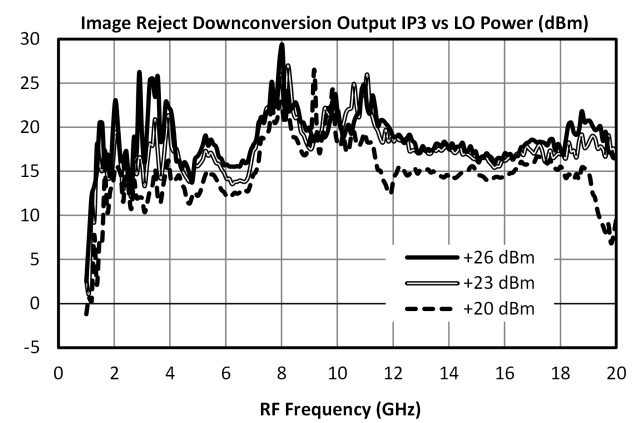
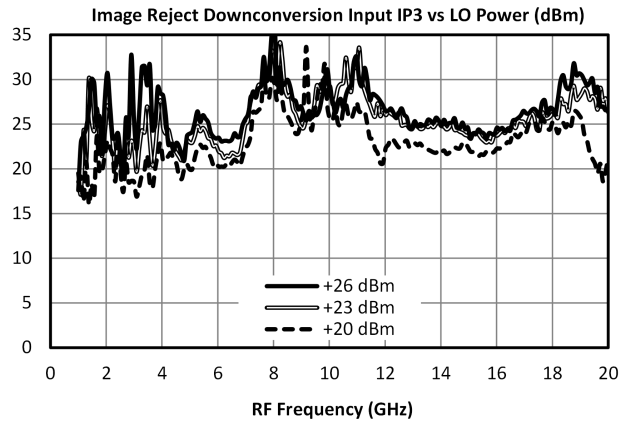
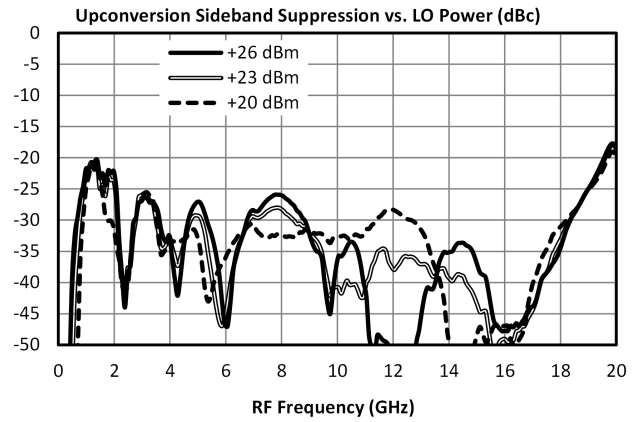
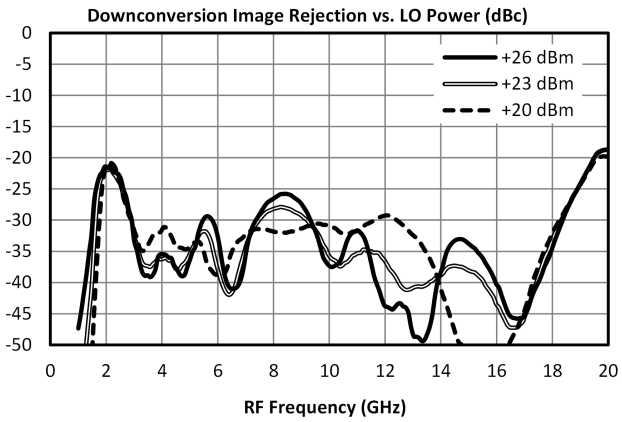

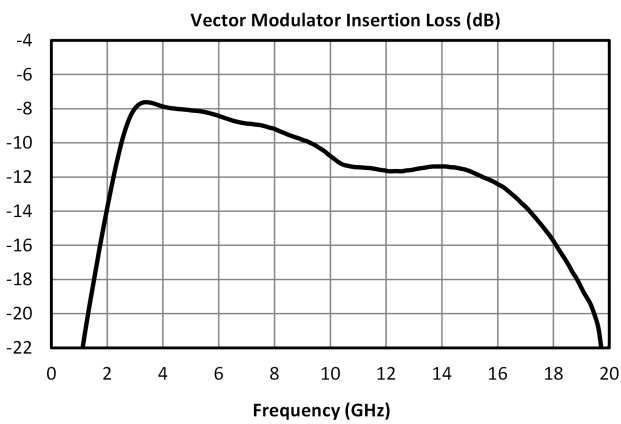
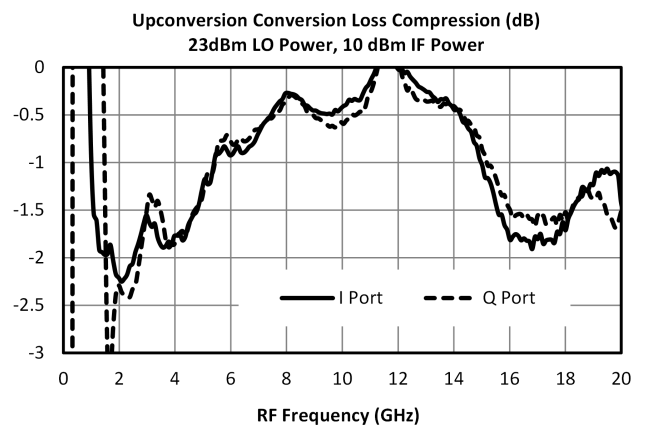
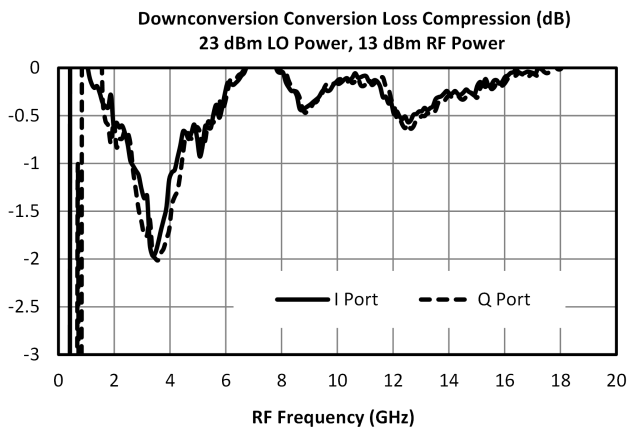
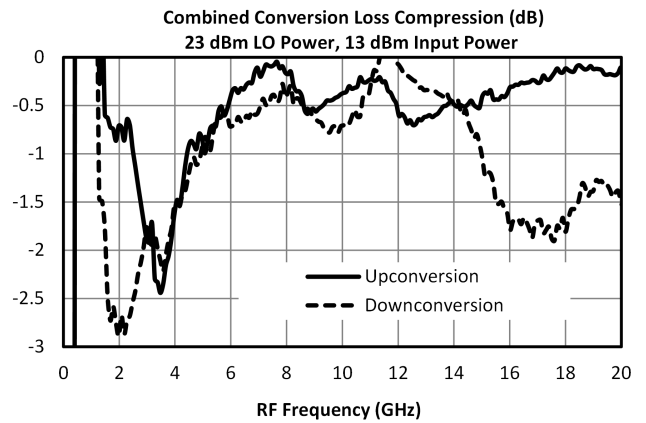
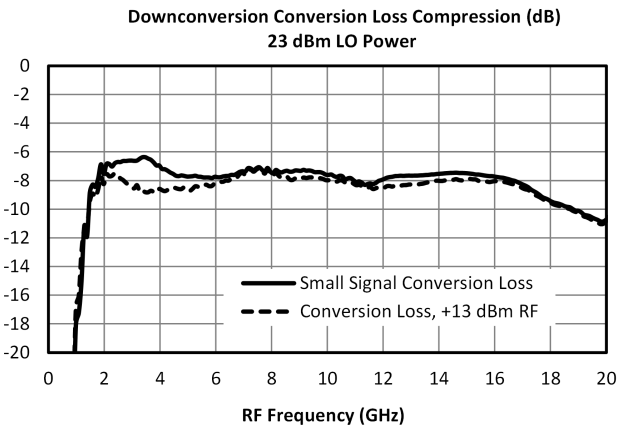
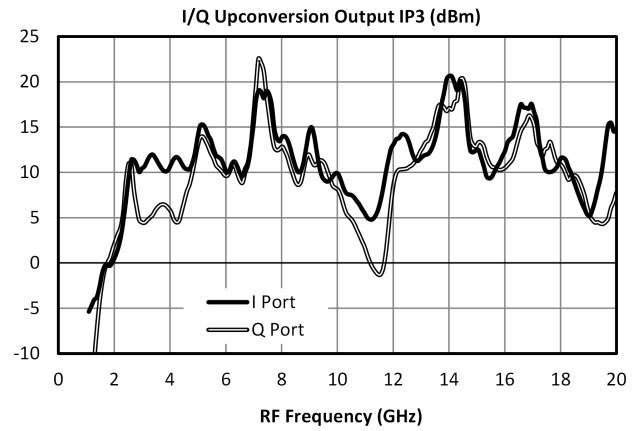
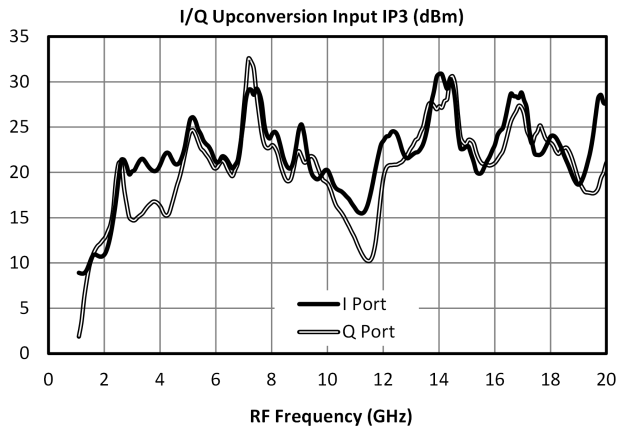

### Typical Harmonic Performance

RF/IF harmonics are measured with a fixed LO of 6.337 GHz at 23 dBm. Note that LO/IF/RF Harmonics are measured across more than the operating band of the mixer. LO Harmonics are not provided due to the lack of a low harmonic, high power LO source. For an estimate of LO harmonic bleedthrough see the MMIQ-0218L datasheet.

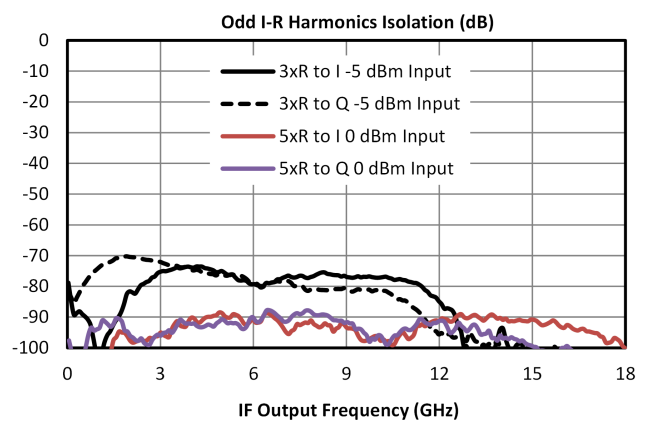
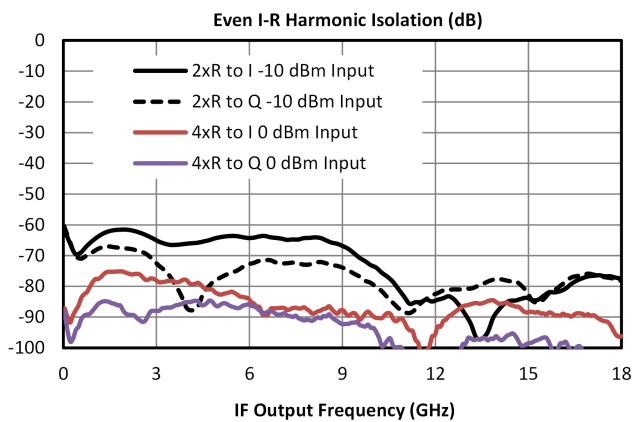
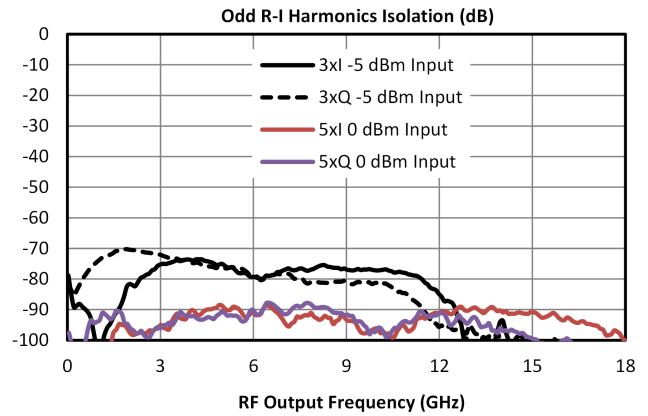
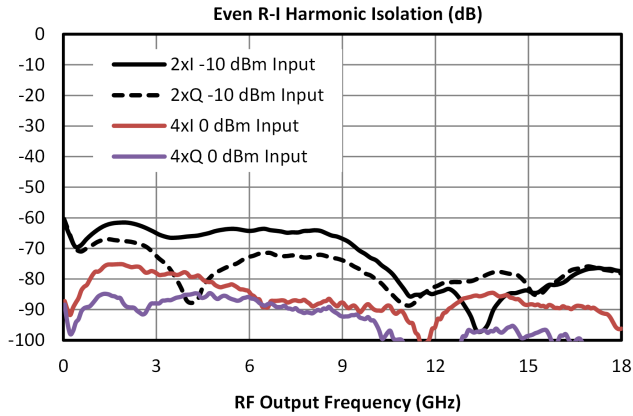

**Typical Spurious Performance: Downconversion**

Typical downconversion spurious data is provided by selecting RF and LO frequencies ( $\pm m \cdot LO \pm n \cdot RF$ ) within the RF/LO bands, to create a spurious output at an IF of 91 MHz. The value of this spur is plotted against the RF input frequency below. Spurious suppression is scaled for different RF power levels by  $(n-1)$ , where "n" is the RF spur order. For example, the  $2RF \times 2LO$  spur is 75 dBc for a -10 dBm input, so a -20 dBm RF input creates a spur that is  $(2-1) \times (-10 \text{ dB})$  lower, or 85 dBc.

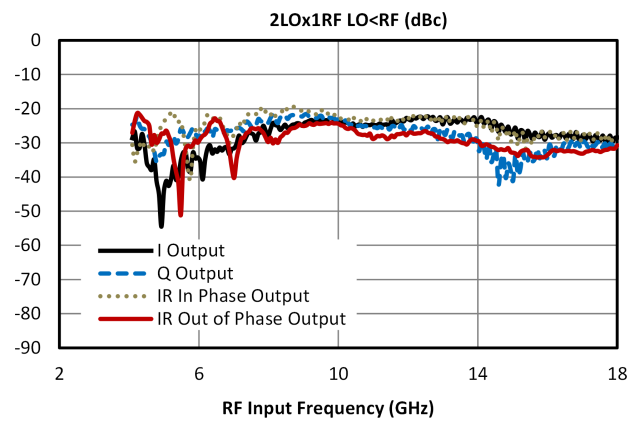
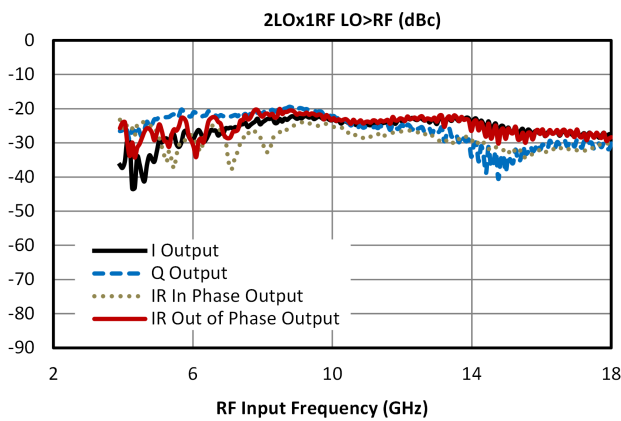
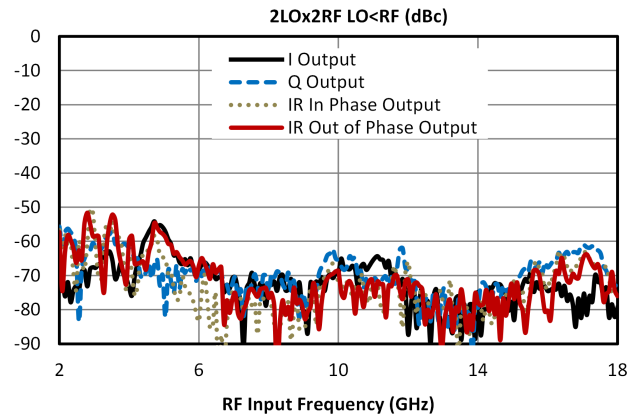
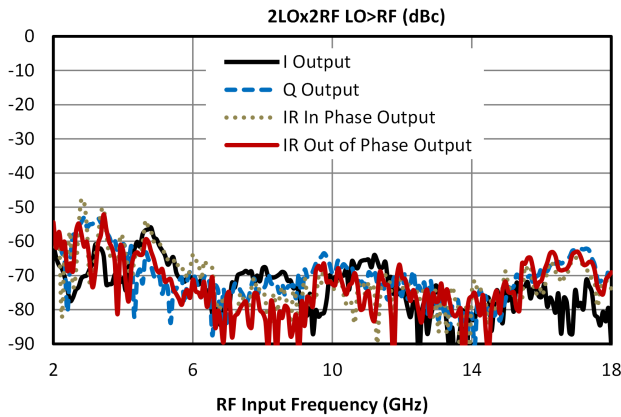

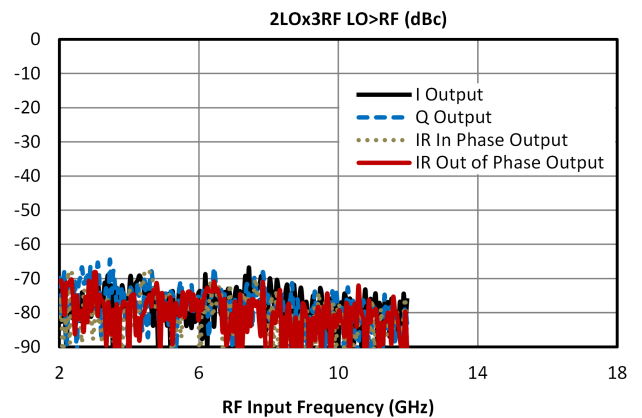
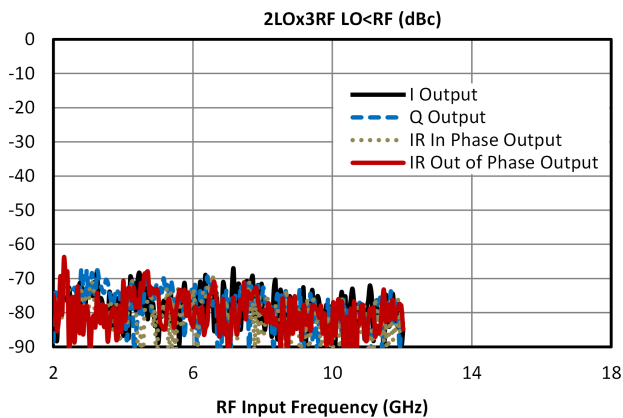
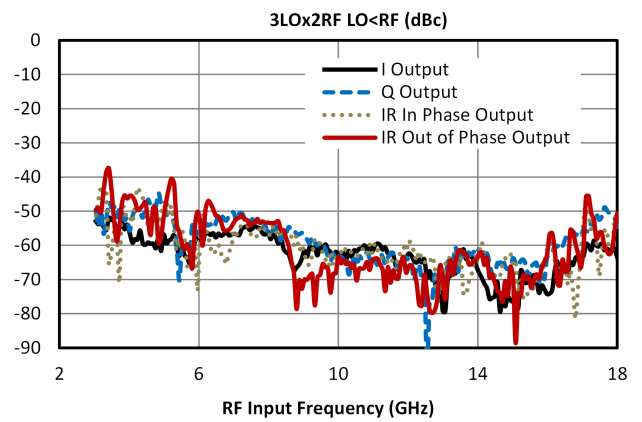
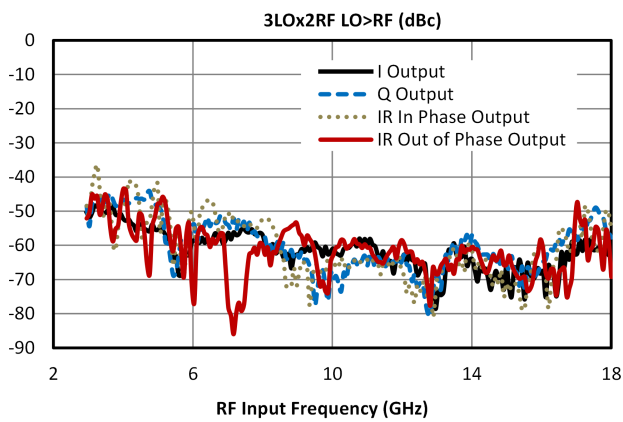
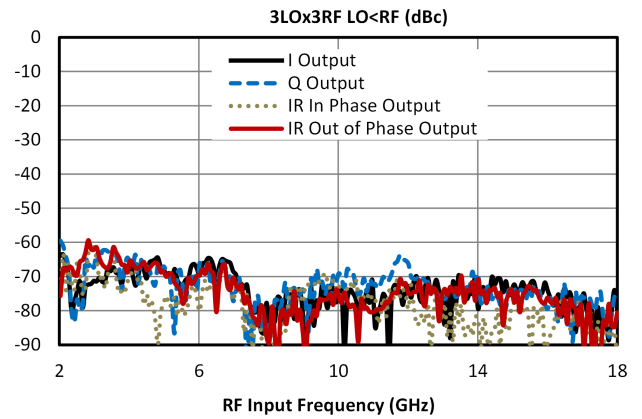
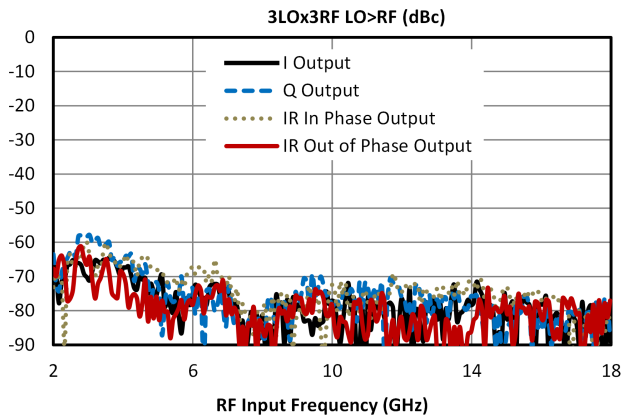
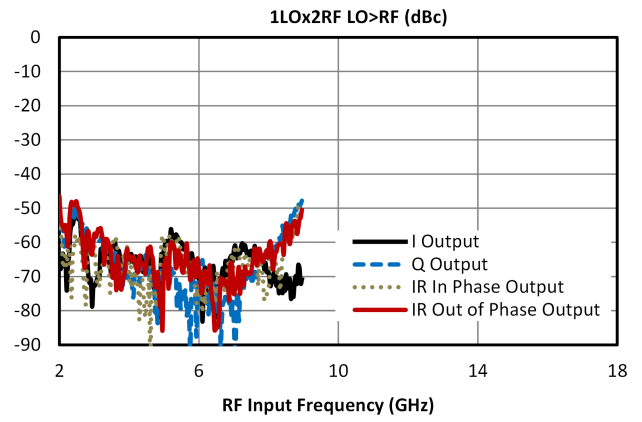
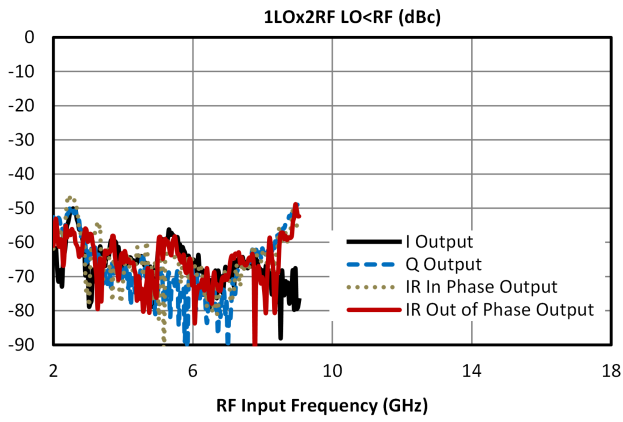

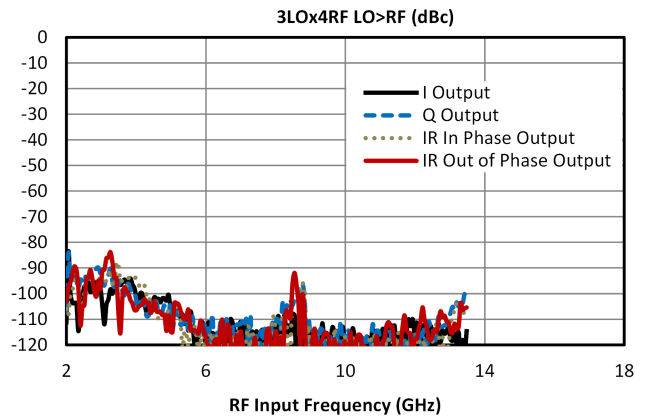
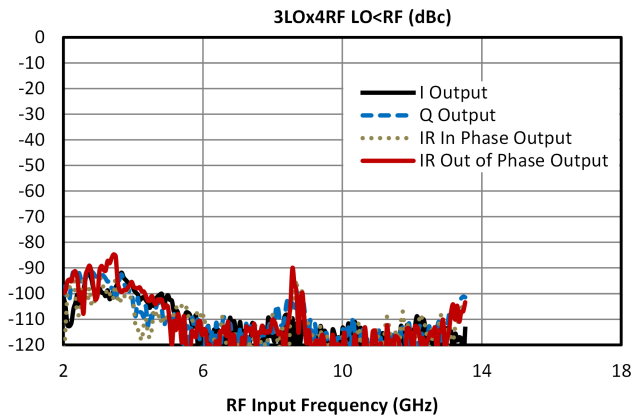
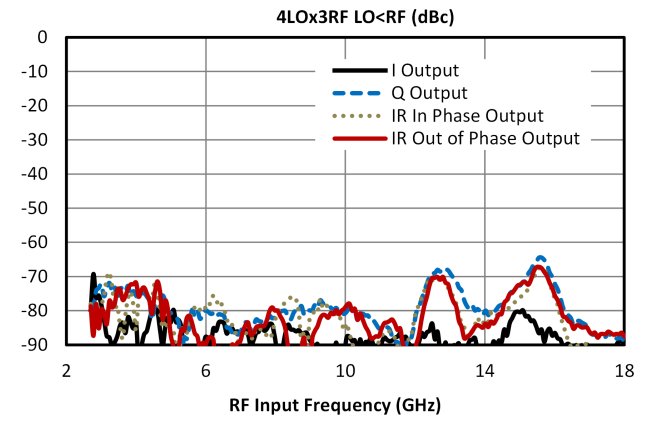
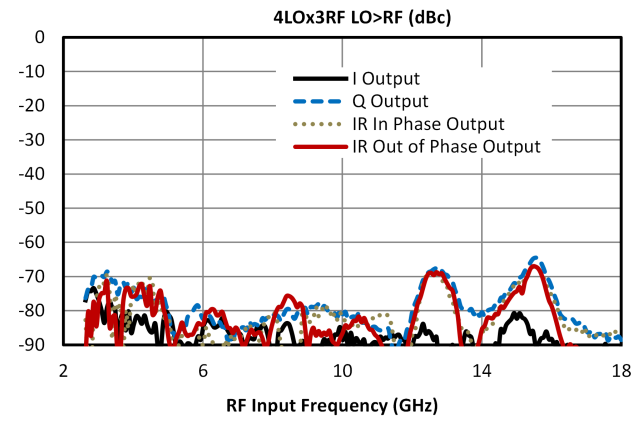
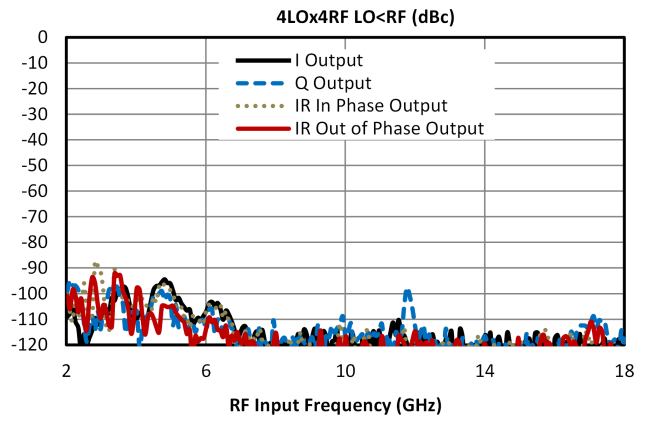
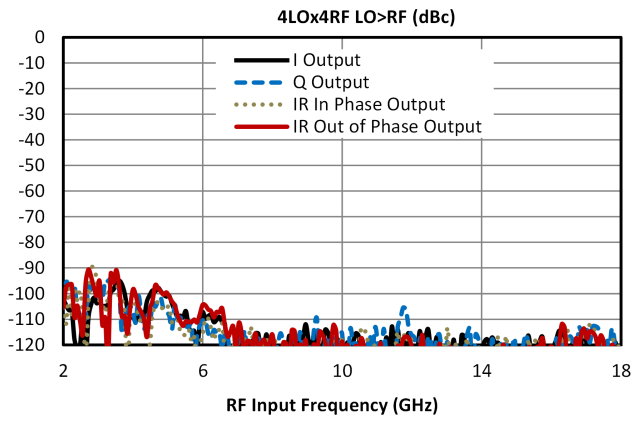

**Typical Spurious Performance: Up-Conversion**

Typical spurious data is taken by mixing an input IF at 91 MHz, with LO frequencies ( $\pm m \cdot LO \pm n \cdot IF$ ), to create a spurious output within the RF output band. The value of this spur is plotted against the RF Output Frequency. Spurious suppression is scaled for different IF input power levels by  $(n-1)$ , where “n” is the IF spur order. For example, the  $2IFx1LO$  spur is typically 22 dBc for a -10 dBm input with a sine-wave LO, so a -20 dBm IF input creates a spur that is  $(2-1) \times (-10 \text{ dB})$  lower, or 32 dBc.

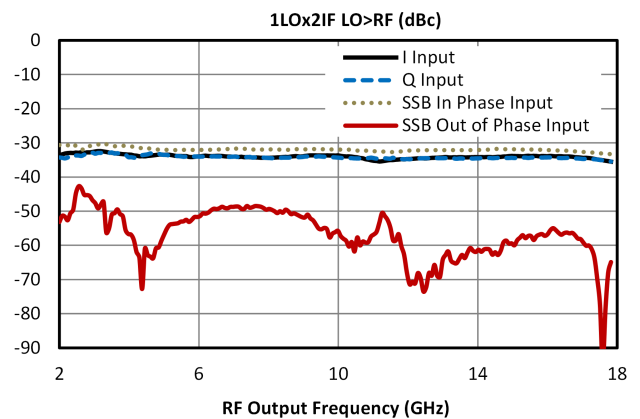
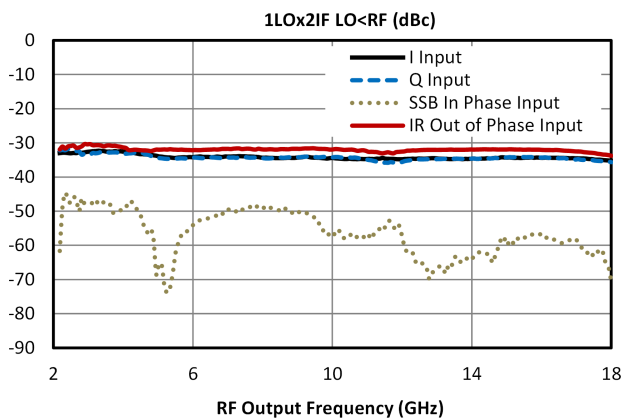
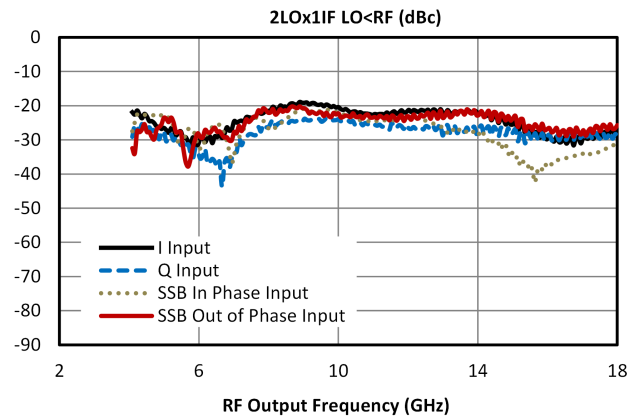
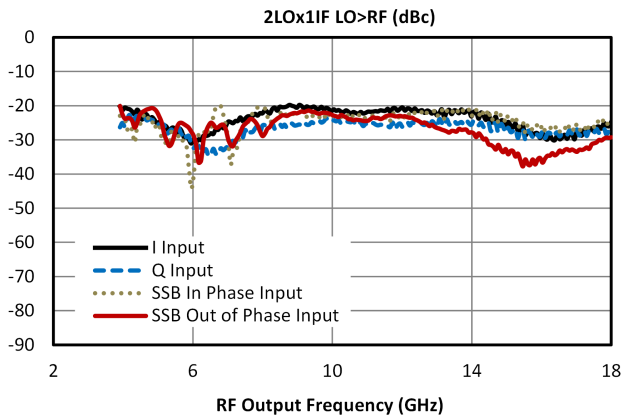
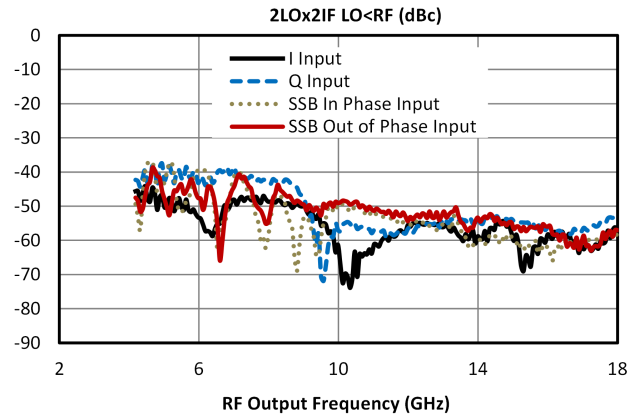
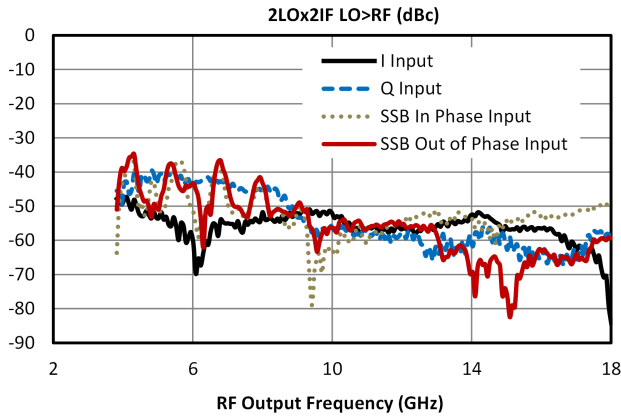

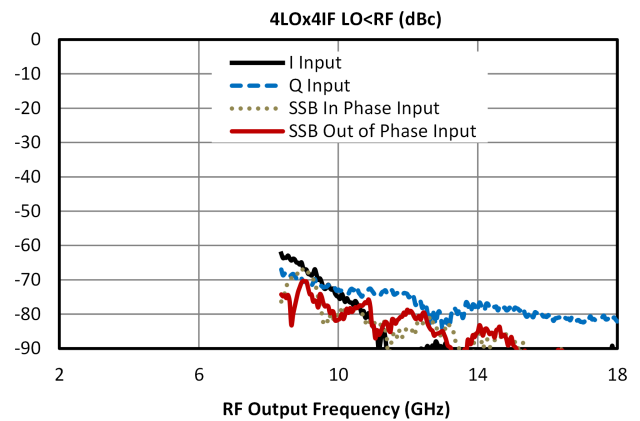
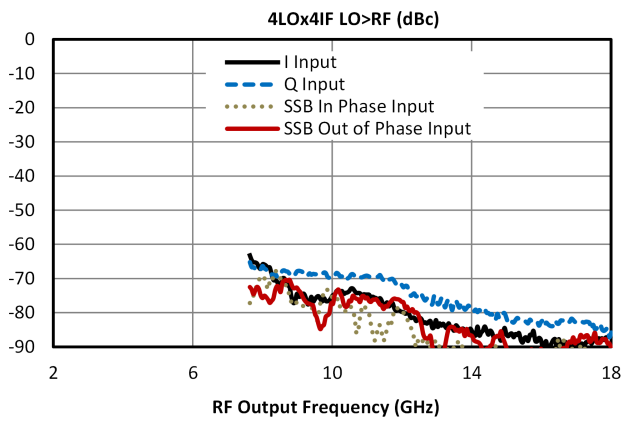
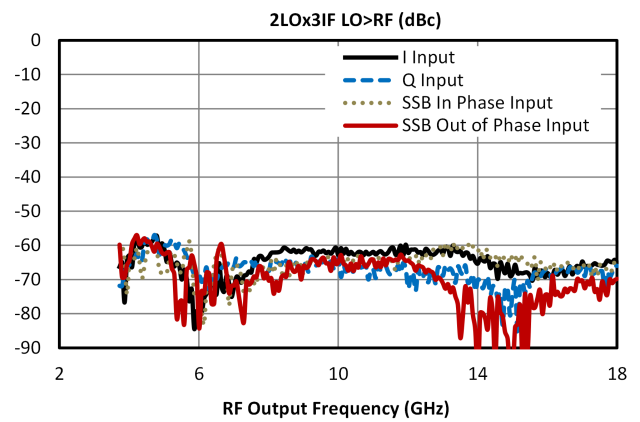
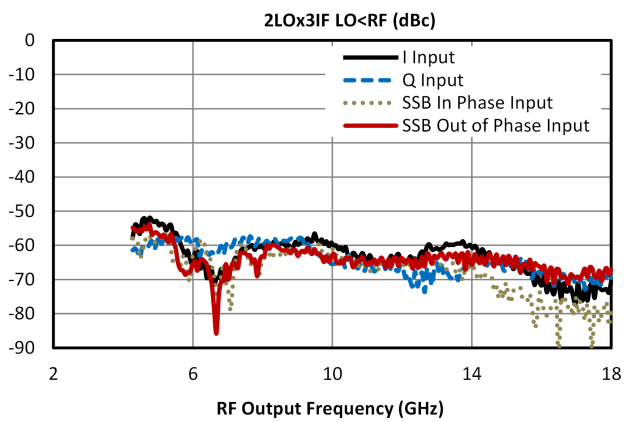
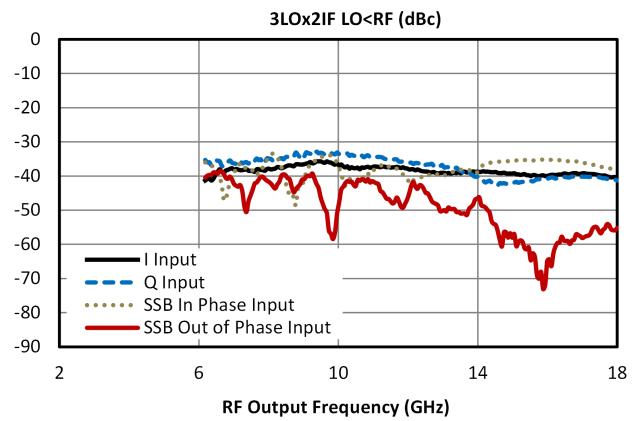
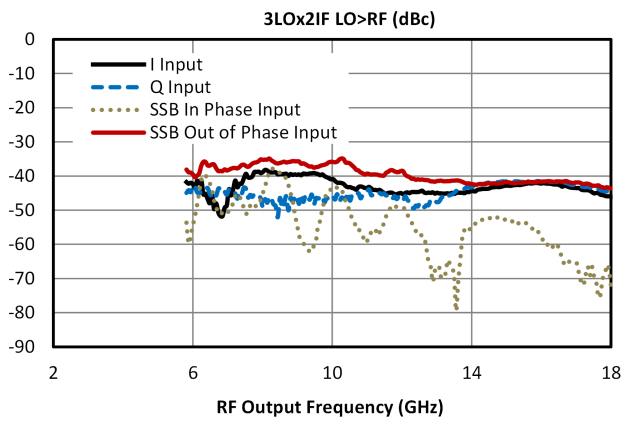
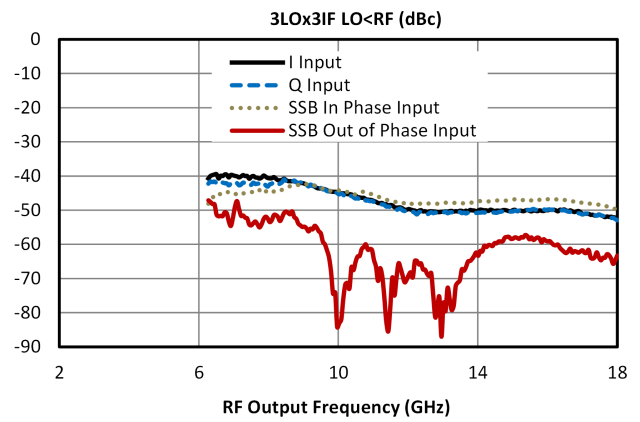
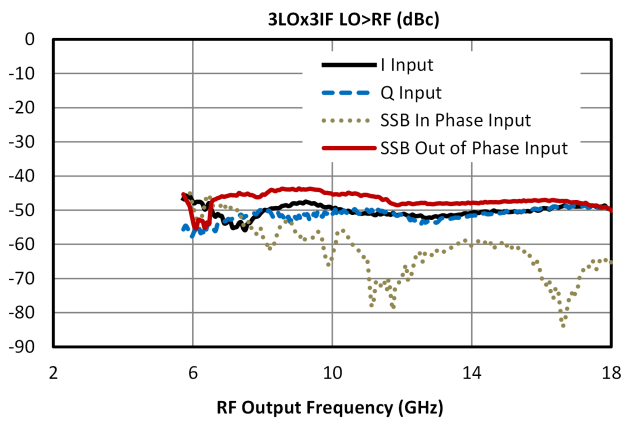

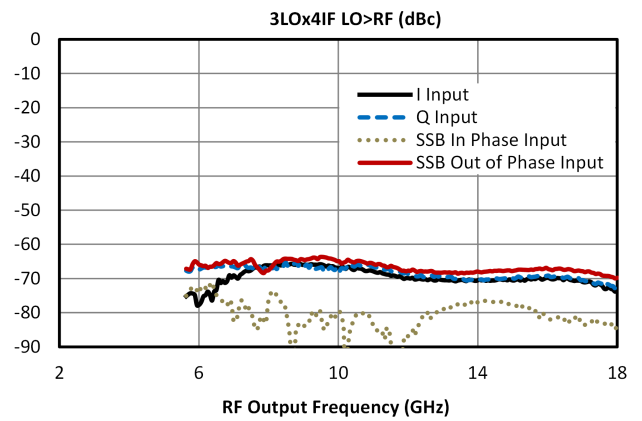
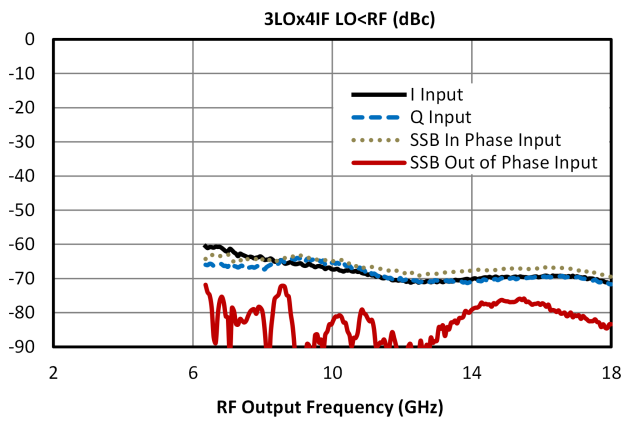
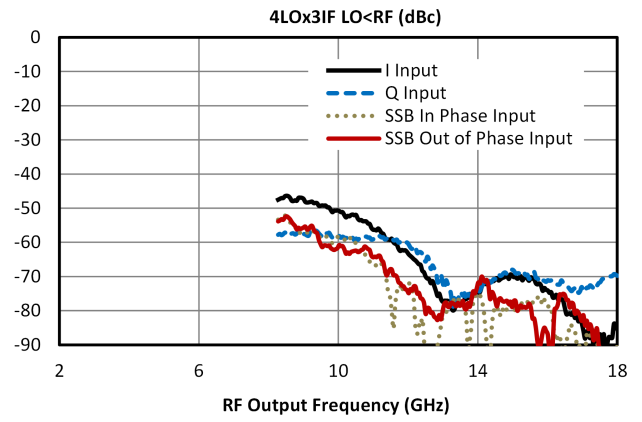
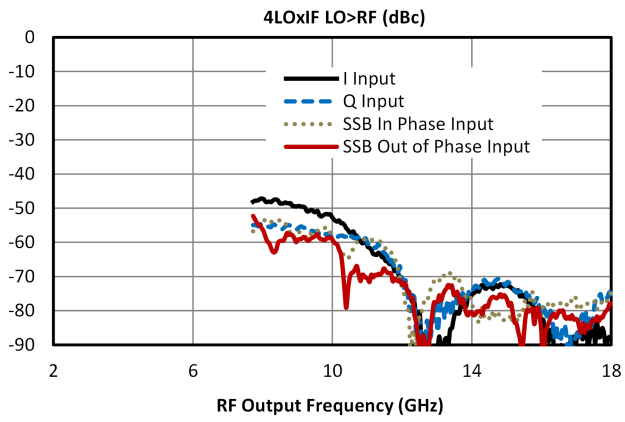

**Spur Table**

<b>I (Q) Configuration Downconversion LO&gt;RF</b>				
<b>-10 dBm RF Input</b>	1xLO	2xLO	3xLO	4xLO
1xRF	Reference	-26 (-26)	N/A	N/A
2xRF	-66 (-67)	-74 (-71)	-62 (-60)	N/A
3xRF	N/A	-78 (-79)	-79 (-77)	-88 (-79)
4xRF	N/A	N/A	-113 (-111)	-117 (-117)

<b>I (Q) Configuration Upconversion LO&gt;RF</b>				
<b>-10 dBm IF Input</b>	1xLO	2xLO	3xLO	4xLO
1xIF	Reference	-24 (-27)	N/A	N/A
2xIF	-34 (-34)	-56 (-54)	-43 (-45)	N/A
3xIF	N/A	-65 (-67)	-50 (-51)	-71 (-70)
4xIF	N/A	N/A	-70 (-68)	-81 (-76)

<b>I (Q) Configuration Downconversion LO&lt;RF</b>				
<b>-10 dBm RF Input</b>	1xLO	2xLO	3xLO	4xLO
1xRF	Reference	-28 (-28)	N/A	N/A
2xRF	-66 (-67)	-72 (-70)	-63 (-59)	N/A
3xRF	N/A	-79 (-78)	-74 (-73)	-88 (-79)
4xRF	N/A	N/A	-112 (-111)	-117 (-115)

<b>I (Q) Configuration Upconversion LO&lt;RF</b>				
<b>-10 dBm IF Input</b>	1xLO	2xLO	3xLO	4xLO
1xIF	Reference	-24 (-28)	N/A	N/A
2xIF	-34 (-34)	-56 (-51)	-38 (-37)	N/A
3xIF	N/A	-63 (-78)	-47 (-48)	-67 (-66)
4xIF	N/A	N/A	-68 (-68)	-90 (-77)

**Application Circuit**

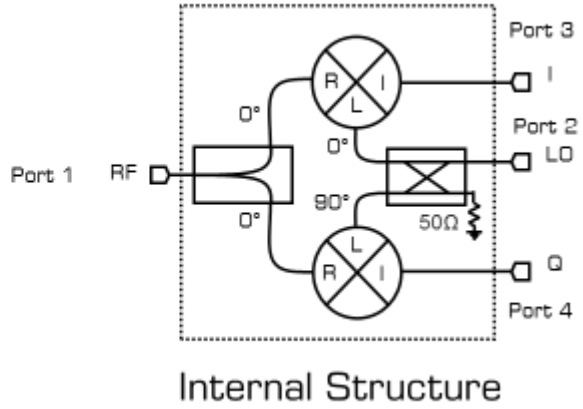
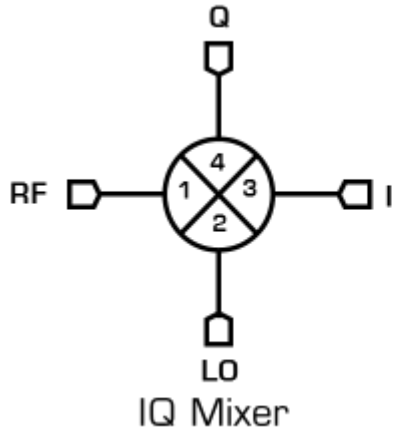

### Application Circuit Description

MMIQ-0218 belongs to Marki Microwave's MMIQ family of mixers. The MMIQ product line consists of passive GaAs MMIC mixers designed and fabricated with GaAs Schottky diodes. MMIQ mixers offer excellent amplitude and phase balance due to its on-chip LO quadrature hybrid. Up to 40 dB of image rejection (i.e., single sideband suppression) can be obtained by using the MMIQ-0218 as an image rejection or single sideband mixer. The MMIQ-0218H is the sister mixer of the MMIQ-0218L. The MMIQ-0218H requires a higher LO drive to operate the mixer. In exchange, the MMIQ-0218H displays higher linearity (i.e., higher IIP3, P1dB, Spurious Suppression) than the MMIQ-0218L. Marki H and L diodes correspond to different diode forward turn on voltages.

Support for the S, C, X, and Ku bands are offered by the ultra-broadband performance of the mixer's RF and LO ports. Traditional use of this mixer to do image reject or single sideband mixing is available with an external IF quadrature hybrid. The MMIQ-0218 is also suitable for use as a Vector Modulator through DC bias of the I and Q ports.

The RF port and the LO port supports a 2-18 GHz signal. The I and Q ports support a DC-3 GHz signal. A signal may be input into any port of the mixer which supports that signal's frequency. This is the basis of using the mixer as a band shifter.

For a given LO power within the recommended operating range, the RF (in the case of a down conversion) or IF (in the case of an up conversion) input power should be below the input 1 dB compression point to avoid signal distortion. The input 1 dB compression point will vary across the mixer's operating bandwidth and with LO input power. Careful characterization is required for optimal performance for each application. There is no minimum small signal input power required for operation. Excessive RF/IF input power increases non-desired spurious output power and degrades the fundamental conversion loss. Excessive LO input power can also cause this effect. The table below describes how to use an IQ mixer and quad hybrid to select a single sideband.

Up Conversion		
Hybrid Port	Mixer Port	Sideband Selected
0	I	Lower Sideband
90	Q	
90	I	Upper Sideband
0	Q	
Down Conversion		
Hybrid Port	Mixer Port	Sideband Selected
0	I	Upper Sideband
90	Q	
90	I	Lower Sideband
0	Q	

**Down-Converter**

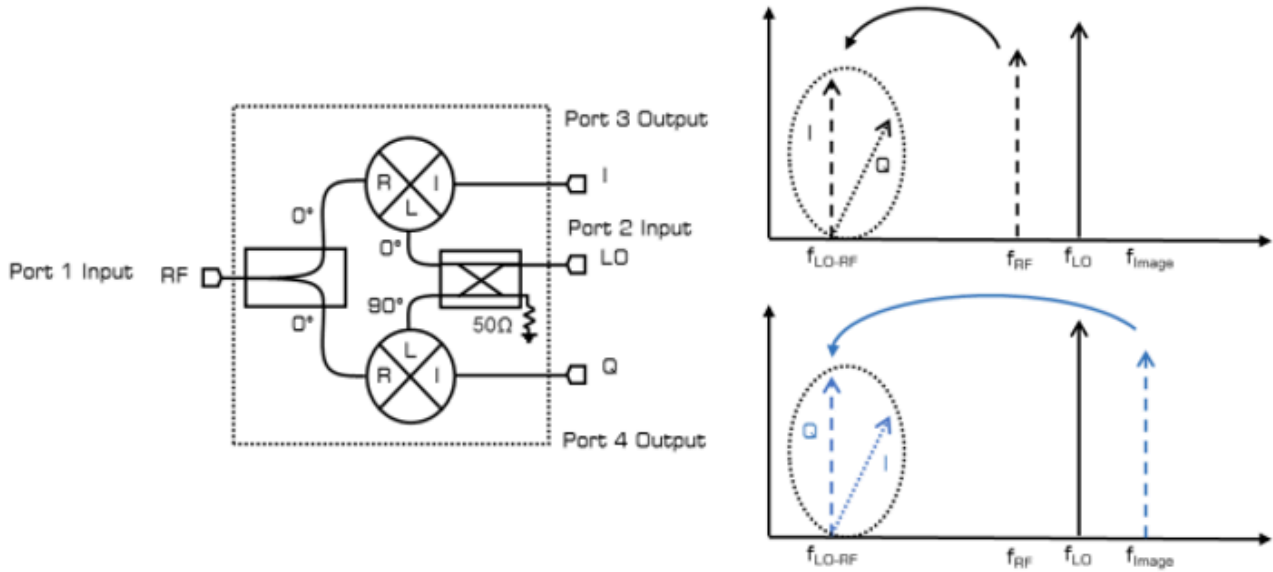

A down converter is a mixer application which takes a high frequency small signal RF input, and a high frequency large signal LO input and mixes the signals together to produce a low frequency IF output. The fundamental  $1RF \times 1LO$  outputs present at the IF port are the  $f_{LO-RF}$  and  $f_{LO+RF}$  tones. The desired output in a down conversion is typically the  $f_{LO-RF}$  term. An image frequency at  $f_{Image} = f_{2LO-RF}$  will also down convert to the  $f_{LO-RF}$  frequency. The above illustration shows the relative location of the image frequency for a highside LO, or the frequency plan for which  $f_{LO} > f_{RF}$ .

To use the IQ mixer as a down converter, input a high frequency small signal RF, a high frequency large signal LO input, and pull the low frequency IF output from the I and Q ports. I and Q IF outputs will be at the same frequency but 90° out of phase (i.e., I and Q are in quadrature). If only a single IF output is desired, terminate either the I or Q ports with a wideband 50Ω load.

This is the input scheme was used to take I/Q down-conversion data found in the Typical Performance Plots section.

**Image Reject Down-Converter**

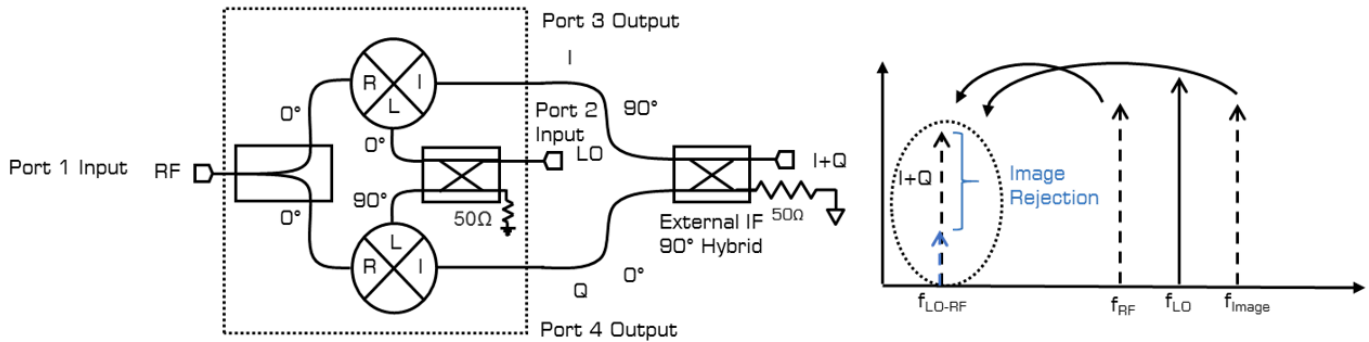

An image reject mixer is a mixer which rejects the down converted image frequency from the IF output. Image reject mixers are constructed using an external quadrature hybrid attached to the I and Q (i.e., IF) output ports. Using the external IF quadrature hybrid, one can select the whether the upper sideband or lower sideband signal is suppressed with respect to the LO signal.

To use the IQ mixer as an image reject mixer, input the high frequency small signal RF and a high frequency large signal LO input. Take the combined I+Q down converted signal through the IF quadrature hybrid. Select the upper sideband (i.e., suppress the lower sideband) by connecting the I port to the 0° port of the IF quadrature hybrid and attach the Q port to the 90° port of the IF quadrature hybrid. Select the lower sideband (i.e., suppress the upper sideband) by attaching the I port to the 90° port of the IF quadrature hybrid and attach the Q port to the 0° port of the IF quadrature hybrid.

This is the input scheme was used to take image rejection down-conversion data found in the Typical Performance Plots section.

## Up-Converter

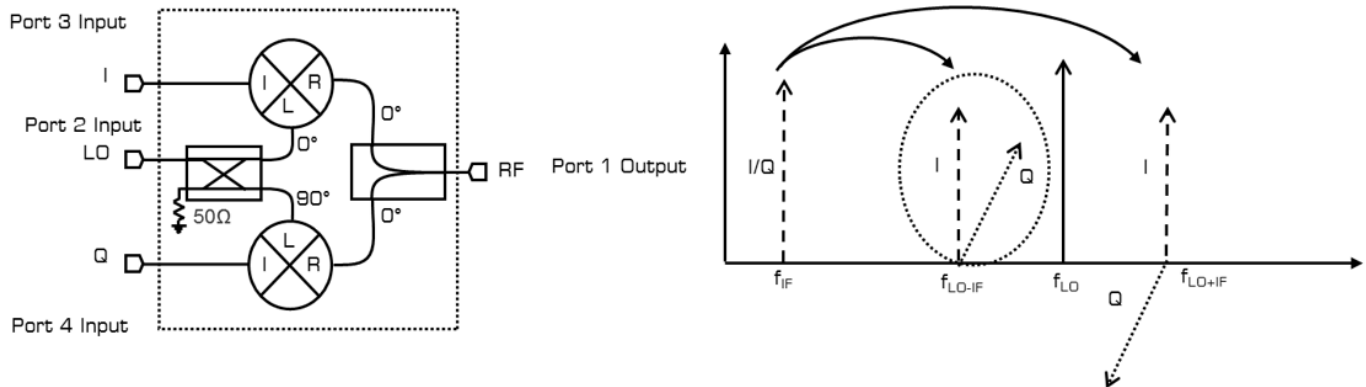

An up converter is a mixer application which takes a low frequency small signal IF input, and a high frequency large signal LO input and mixes the signal together to produce a high frequency RF output. The fundamental  $1f_{IF} \times 1f_{LO}$  outputs present at the RF port are the  $f_{LO-IF}$  and  $f_{LO+IF}$  tones. An up conversion can select either the  $f_{LO-IF}$  or the  $f_{LO+IF}$  tones. The above illustration shows both up converted sidebands with either an I or Q port input signal.

To use the IQ mixer as an up converter, input a low frequency small signal IF input into the I or Q port, a high frequency large signal LO input into the LO port, and pull the high frequency RF output from the RF port. Input into the Q port will result in a up converted signal that is 90° out of phase with the up converted I port input signal. If only a single IF input is desired, terminate either the I or Q ports with a wideband 50Ω load.

This is the input scheme used to take I/Q up-conversion data found in Typical Performance.

### Single Sideband Up-Converter

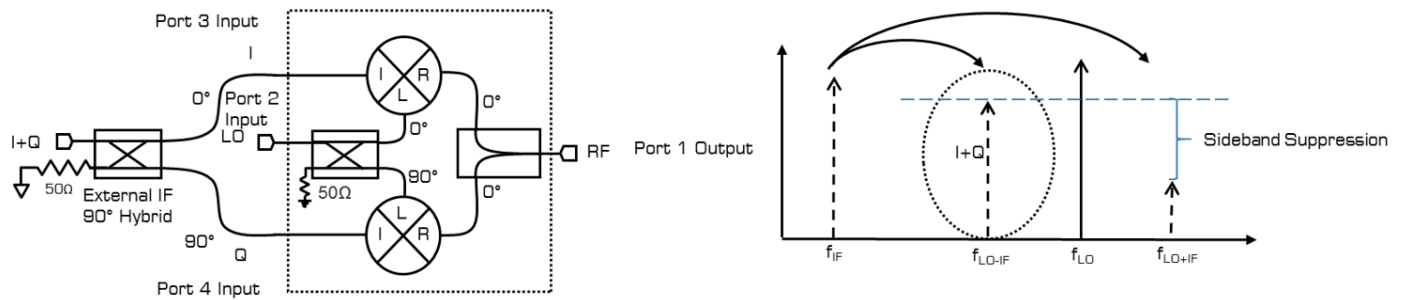

A single sideband mixer is a mixer which suppresses the up converted image frequency from the RF output. Single sideband mixers are constructed using an external quadrature hybrid attached to the I and Q (i.e., IF) input ports. Using an external IF quadrature hybrid, one can select whether the upper sideband of the lower sideband signal is suppressed with respect to the LO signal.

To use the IQ mixer as a single sideband mixer, input the low frequency small signal I+Q IF signal into the IF quadrature hybrid. The IF quadrature hybrid is attached to the I and Q ports of the IQ mixer. Input the high frequency large signal LO input into the LO port and take the up converted high frequency RF signal from the RF port. Select the upper sideband (i.e., suppress the lower sideband) by attaching the I port to the 90° port of the IF quadrature hybrid and attach the Q port to the 0° port of the IF quadrature hybrid. Select the lower sideband (i.e., suppress the upper sideband) by attaching the I port to the 0° port of the IF quadrature hybrid and attach the Q port to the 90° port of the IF quadrature hybrid.

This is the input scheme used to take single sideband up-conversion data found in Typical Performance.

## Band Shifter

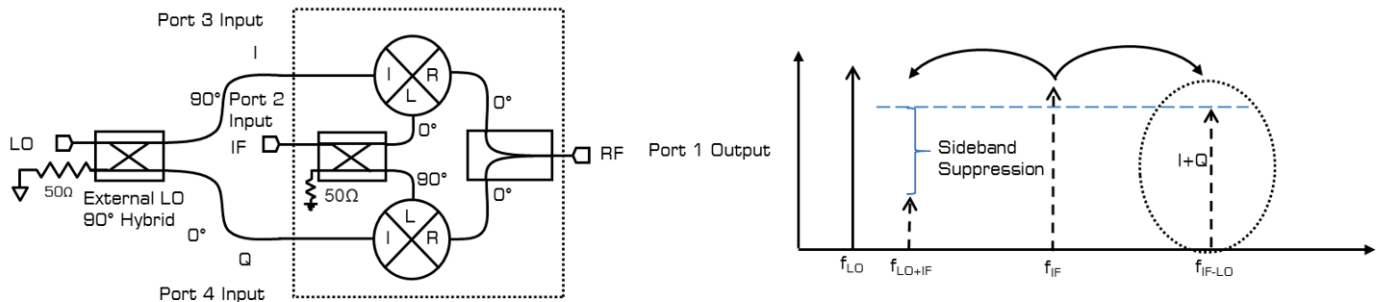

A band shifter is an unusual application for a mixer. Band shifters take an IF signal and shift it to a different band, generally to either avoid interference or for rebroadcast at a different frequency. For cases in which the desired band shift cannot be employed by using a standard up or down conversion scheme, an exotic input scheme is required.

A passive diode mixer is reciprocal on all ports. The LO and RF ports support a 2-18 GHz signal. The I and Q ports support a DC-3 GHz signal. 2 signals input into any combination of the 3 ports, RF, LO, or IF, will result in an output signal at the 3<sup>rd</sup> port. In addition, an output signal will be present at both input ports. By using the IF port, as a large signal input port, low frequency LO applications can be supported.

The diagram above shows an IQ mixer being used as a band shifter. Using an IQ mixer as a band shifter allows for sideband suppression. This is identical to using the IQ mixer as a single sideband up converter. However, the large signal input port is now into the I and Q ports instead of the LO port. Selection of the output tone is done through the orientation of the LO quadrature hybrid.

To use the mixer as a single sideband band shifter, input a low frequency large signal LO into the external LO quadrature hybrid. Input the high frequency small signal IF signal into the LO port and take the high frequency RF output from the RF port. Select the upper sideband (i.e., suppress the lower sideband) by connecting the I port to the 90° port of the IF quadrature hybrid and connect the Q port to the 0° port of the LO quadrature hybrid. Select the lower sideband (i.e., suppress the upper sideband) by connecting the I port to the 0° port of the LO quadrature hybrid and connect the Q port to the 90° port of the LO quadrature hybrid.

Using this input scheme requires careful accounting of which input signal is injected which port. Injecting a signal into any port which does not support the correct band will lead to a degraded or no output response. Abide by the maximum DC current input into the I and Q ports of the mixer or otherwise irreversible damage to the mixer will occur.

The limiting factor in use of the mixer as an image reject band shifter is in the bandwidth of the external LO quadrature hybrid and bandwidth of the I and Q ports.

## Vector Modulator

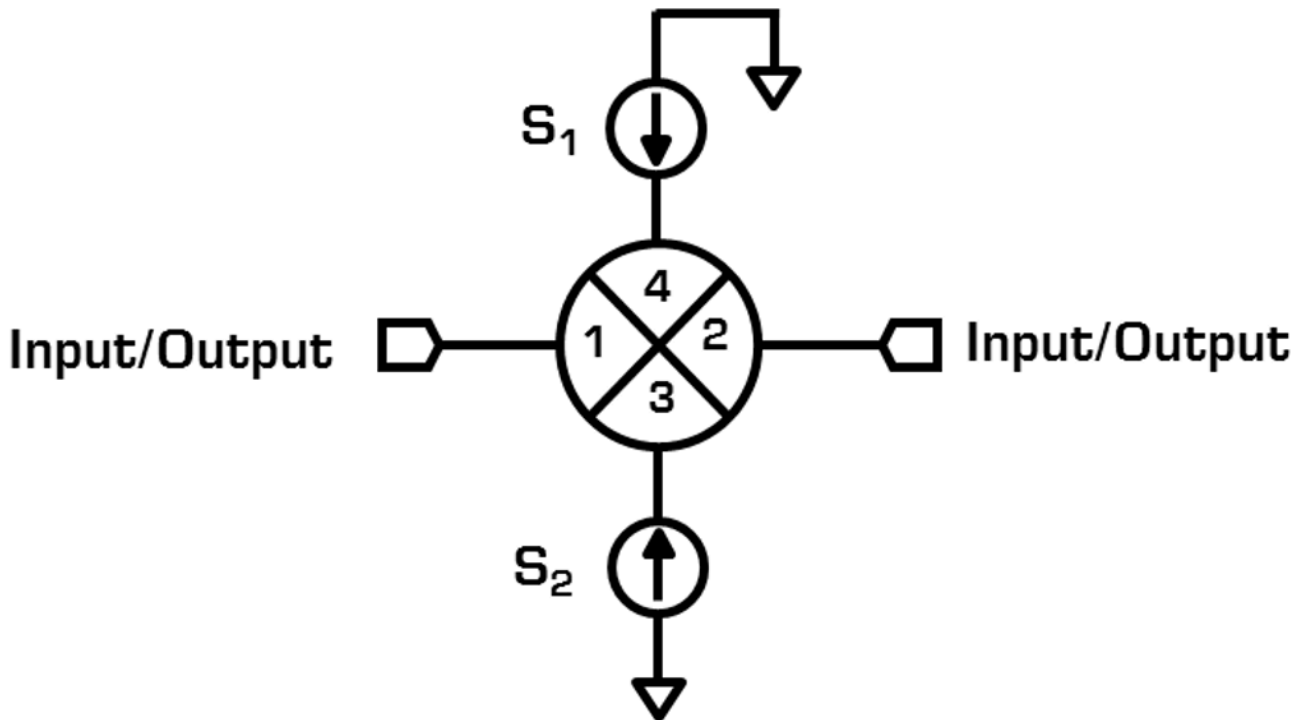

A vector modulator is a device that can modulate an input signal's amplitude and phase. Similar to using a double balanced mixer as a phase modulator or phase shifter, an IQ mixer can be used as a vector modulator. An IQ mixer can be used as a vector modulator by inputting DC current into both the I and Q ports.

Injecting DC current into both the I and Q ports forward biases both mixer cores and causes them to be shorted. This connects the RF and LO baluns allowing the input signal to pass from balun to balun without a frequency conversion. Modulating the DC current into either or both I and Q mixers causes both the phase and amplitude to modulate based on the polarity of the input current and the magnitude of the input current. Modulating only the I or Q mixers causes the device to behave as a biphaser modulator (i.e., the device can only swing the phase from  $+90^\circ$  to  $-90^\circ$ ).

To use the IQ mixer as a vector modulator, supply a DC current sufficient to turn on the mixer through both the I and Q ports. An example bias condition is given in section **Error! Reference source not found.** for the MMIQ-0218L with the phase set to  $0^\circ$ ,  $90^\circ$ ,  $180^\circ$ , and  $270^\circ$  for a 10GHz input. Current limiting the DC source to the maximum DC current value found in Absolute Maximum Ratings is recommended to prevent irreversible damage to the vector modulator. The typical DC current required to turn on the vector modulator is  $<30\text{mA}$ .

This is the measurement scheme used to take vector modulator data found in the Typical Performance Plots: Vector Modulator section.

It is recommended to sequence the vector modulator by slowly increasing the DC bias until the vector modulator is operating at the user desired condition.

Near the band edges of the vector modulator, more current than is typical for mid-band operation may be necessary to achieve the same amplitude and phase shift. This is due to the on chip LO quadrature hybrid operating near it's band edge.

**Mechanical Data**

**Outline Drawing**

Download : [Outline 2D Drawing](#) | [Outline 3D Drawing](#) | [Outline 3D STP](#)

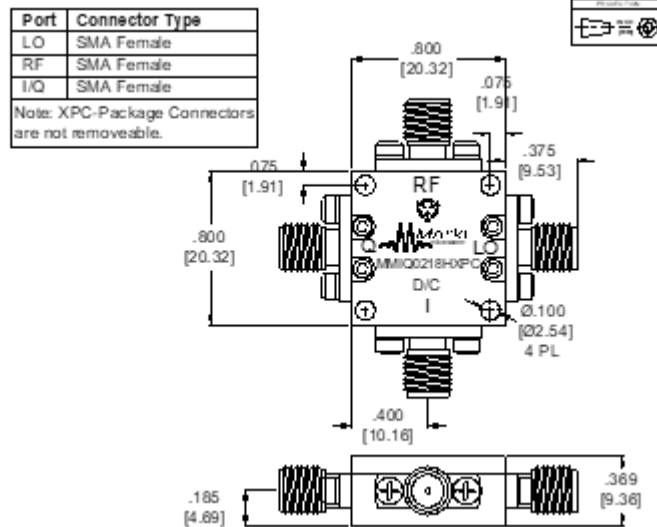

**DISCLAIMER**

MARKI MICROWAVE, INC., ("MARKI") PROVIDES TECHNICAL SPECIFICATIONS AND DATA (INCLUDING DATASHEETS), APPLICATION OR OTHER DESIGN ADVICE, WEB TOOLS, AND OTHER INFORMATION AND RESOURCES "AS IS" AND WITH ALL FAULTS. MARKI DISCLAIMS ALL WARRANTIES, EXPRESS OR IMPLIED, INCLUDING, WITHOUT LIMITATION, ANY IMPLIED WARRANTIES OF MERCHANTABILITY, FITNESS FOR A PARTICULAR PURPOSE, OR NON-INFRINGEMENT. These resources are intended for developers skilled in the art designing with Marki products. You are solely responsible for (1) selecting the appropriate products for your application, (2) designing, validating, and testing your application, and (3) ensuring your application meets applicable standards and other requirements. Marki makes no guarantee regarding the suitability of its products for any particular purpose, nor does Marki assume any liability whatsoever arising out of your use or application of any Marki product.

Marki grants you permission to use these resources only for development of an application that uses Marki products. Other reproduction or use of these resources is strictly prohibited. No license is granted to any other Marki intellectual property or to any third-party intellectual property. Marki reserves the right to make changes to the product(s) or information contained herein without notice.

MARKI MICROWAVE and T3 MIXER are trademarks or registered trademarks of Marki Microwave, Inc. All other trademarks used are the property of their respective owners.

© 2019 - 2020, Marki Microwave, Inc