

MFBA-00004PSM

Passive GaAs MMIC 8.40-12.50 GHz Bandpass Filter

DEVICE OVERVIEW

General Description

The MFBA-00004PSM family of passive MMIC surface mount bandpass filters are an ideal solution for small form factor, high rejection filtering. Passive GaAs MMIC technology allows production of smaller filter constructions that replace larger form factor circuit board constructions. Tight fabrication tolerances allow for less unit to unit variation than traditional filter technologies. The MFBA-00004PSM is available as a 5x5mm plastic QFN. Low unit to unit variation allows for accurate simulations using the provided S2P file taken from measured production units.

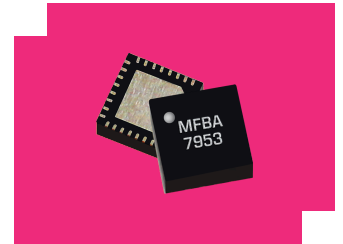

[Download s-parameters here](#)

Features

- Excellent Return Loss
- High Stop Band Suppression
- Wide Stop Band with Fast Roll-Off

Applications

N/A

Functional Block Diagram



Part Ordering Options

Part Number	Description	Package	Green Status	Product Lifecycle	Export Classification
MFBA-00004PSM	Passive GaAs MMIC 8.40-12.50 GHz Bandpass Filter	QFN	RoHS REACH	Released	EAR99
EVB-MFBA-00004P	Evaluation Board, Passive GaAs MMIC 8.40-12.50 GHz Bandpass Filter	EVB	Consult Factory	Released	EAR99

MFBA-00004PSM

Passive GaAs MMIC 8.40-12.50 GHz Bandpass Filter

Table Of Contents

- **Device Overview**
 - General Description
 - Features
 - Applications
 - Functional Block Diagram
- **Port Configuration and Functions**
 - Port Diagram
 - Port Functions
- **Revision History**
- **Specifications**
 - Absolute Maximum Ratings
 - Package Information
 - Electrical Specifications
 - Typical Performance Plots
- **Mechanical Data**
 - Outline Drawing
- **Footprint Image**
- **Evaluation Board**
 - Evaluation Board Outline Drawing

Revision History

Revision Code	Revision Date	Comment
-	2022-10-01	Datasheet Initial Release

MFBA-00004PSM

Passive GaAs MMIC 8.40-12.50 GHz Bandpass Filter



Port Configuration and Functions

Port Diagram

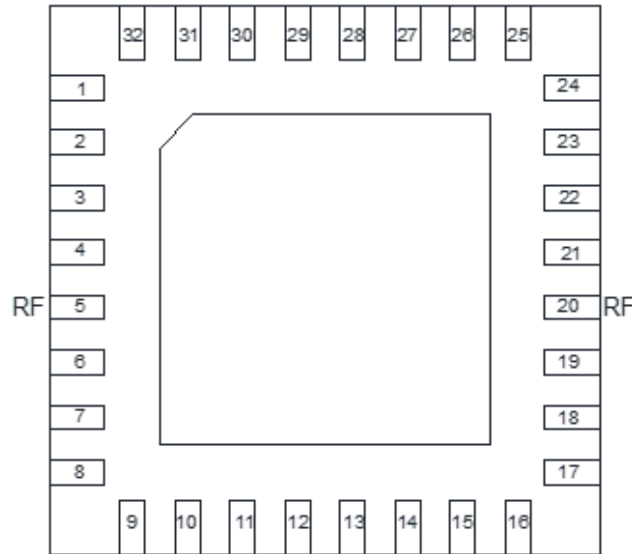
A top-down x-ray view of the MFBA-00004PSM package outline drawing is shown below. The MMIC bandpass filters are symmetrical allowing Pin 5 or Port 20 to be used as the input.

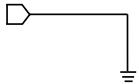

Port Functions

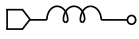
Port	Function	Description	Equivalent Circuit for Package
Ground Paddle	Ground	PSM package ground path is provided through the ground paddle and should be connected to RF ground.	
Pin 20	Input/Output	Pin 20 is DC open to ground for the PSM package.	
Pin 5	Input/Output	Pin 5 is DC open to ground for the PSM package.	

Specifications

Absolute Maximum Ratings

The Absolute Maximum Ratings indicate limits beyond which damage may occur to the device. If these limits are exceeded, the device may be inoperable or have a reduced lifetime.

Parameter	Maximum Rating	Unit
Maximum Operating Temperature	100	°C
Maximum Storage Temperature	125	°C
Minimum Operating Temperature	-55	°C
Minimum Storage Temperature	-65	°C
Port 1 DC Current	400	mA
Port 2 DC Current	400	mA

Package Information

Parameter	Details	Rating
Dimensions	-	5 x 5 mm
Moisture Sensitivity Level	-	MSL 1

MFBA-00004PSM

Passive GaAs MMIC 8.40-12.50 GHz Bandpass Filter

Electrical Specifications

The electrical specifications apply at TA=+25°C in a 50Ω system. Typical data shown is for the filter in a PSM package with a sine wave input applied to Pin 5. Min and Max limits are guaranteed at TA=+25°C.

Parameter	Test Conditions	Minimum Frequency (GHz)	Maximum Frequency (GHz)	Min	Typ	Max	Unit
1 dBc Passband	Configuration A, Temp = 25°C, Input Power = -5.00 dBm	8.42	12.32	-	-	-	GHz
3 dBc Passband	Configuration A, Temp = 25°C, Input Power = -5.00 dBm	7.94	12.52	-	-	-	GHz
30 dBc Rejection Point	Configuration A, Temp = 25°C, Input Power = -5.00 dBm	7.18	13.74	-	-	-	GHz
Center Freq	Configuration A, Temp = 25°C, Input Power = -5.00 dBm	-	-	-	10.19	-	GHz
Insertion Loss @ fc	Configuration A, Temp = 25°C, Input Power = -5.00 dBm	-	-	-	1.8	-	dB
Passband Return Loss	Configuration A, Temp = 25°C, Input Power = -5.00 dBm	-	-	-	19	-	dB
Group Delay	Configuration A, Temp = 25°C, Input Power = -5.00 dBm	-	-	-	503	-	ps
Impedance	Configuration A, Temp = 25°C, Input Power = -5.00 dBm	-	-	-	50	-	Ω

MFBA-00004PSM

Passive GaAs MMIC 8.40-12.50 GHz Bandpass Filter

Typical Performance Plots

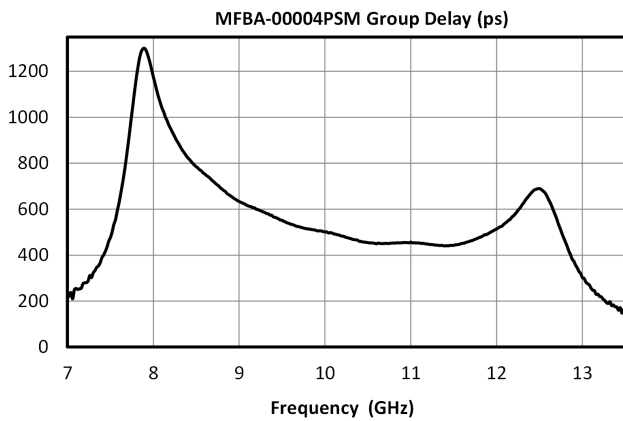
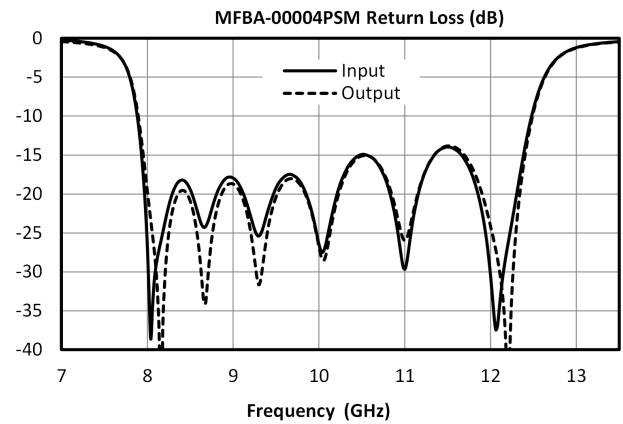
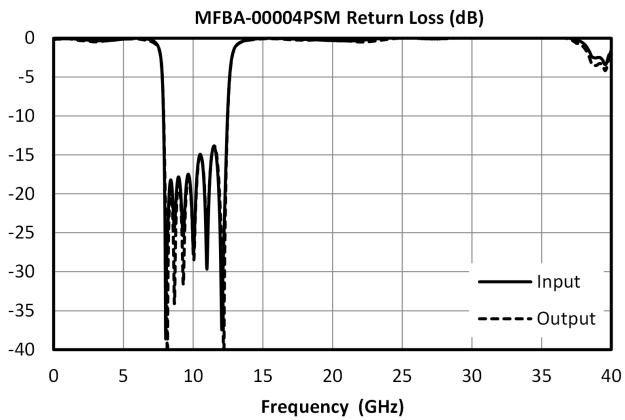
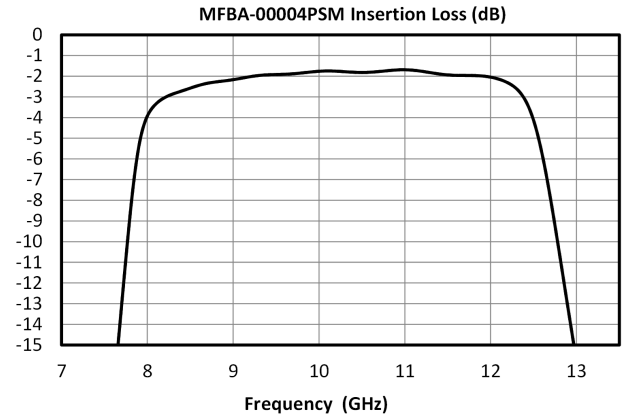
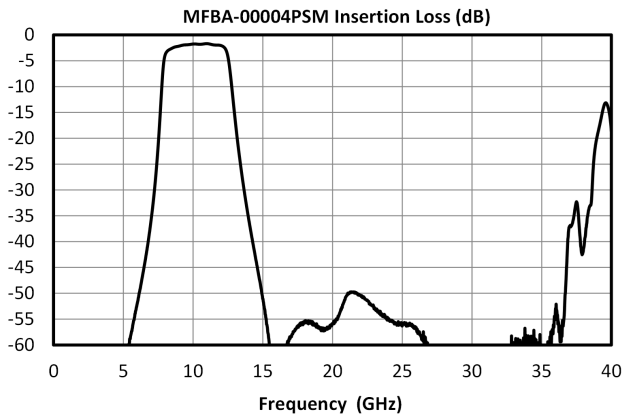

MFBA-00004PSM

Passive GaAs MMIC 8.40-12.50 GHz Bandpass Filter

Mechanical Data

Outline Drawing

Download : [Outline 2D Drawing](#) | [Outline 3D Drawing](#) | [Outline 3D STP](#)

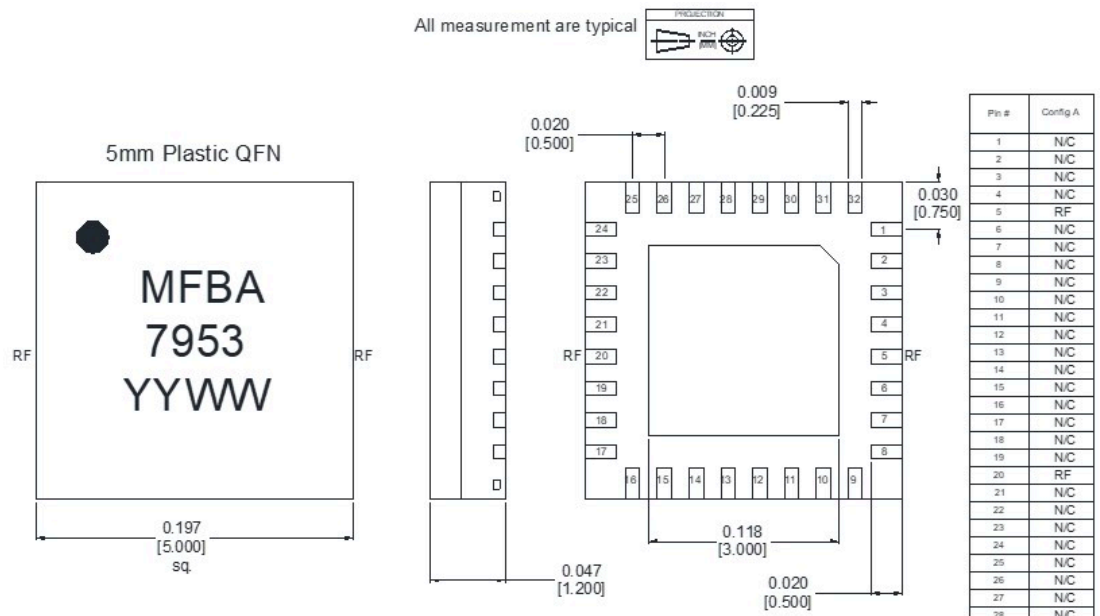

- Notes (unless otherwise specified):
- Substrate material is LCP.
 - I/O Leads and Die Paddle are:
0.008 - 0.05 μ m Gold, over
0.02 - 0.15 μ m Palladium, over
0.5 - 2.0 μ m Nickel.
 - All unconnected pins should be connected to PCB RF ground.

Part Number	Lid Label
MFBA-00001PSM	7950
MFBA-00002PSM	7951
MFBA-00003PSM	7952
MFBA-00004PSM	7953

MFBA-00004PSM

Passive GaAs MMIC 8.40-12.50 GHz Bandpass Filter

Footprint Image

Download : [Footprint Drawing](#)

QFN 5mm Sample Drawing
X-Ray view

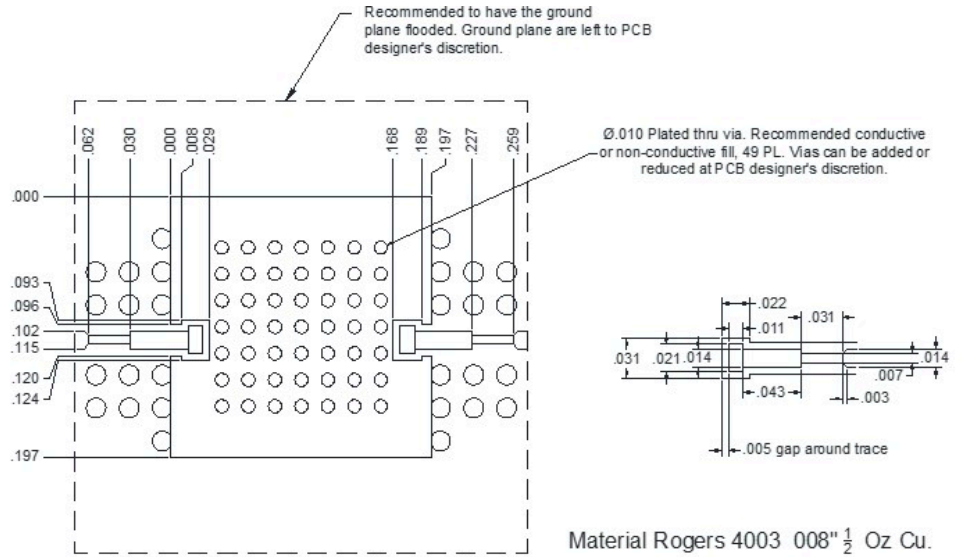
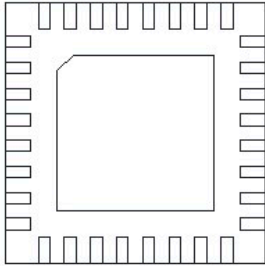

MFBA-00004PSM

Passive GaAs MMIC 8.40-12.50 GHz Bandpass Filter

Evaluation Board - Outline Drawing

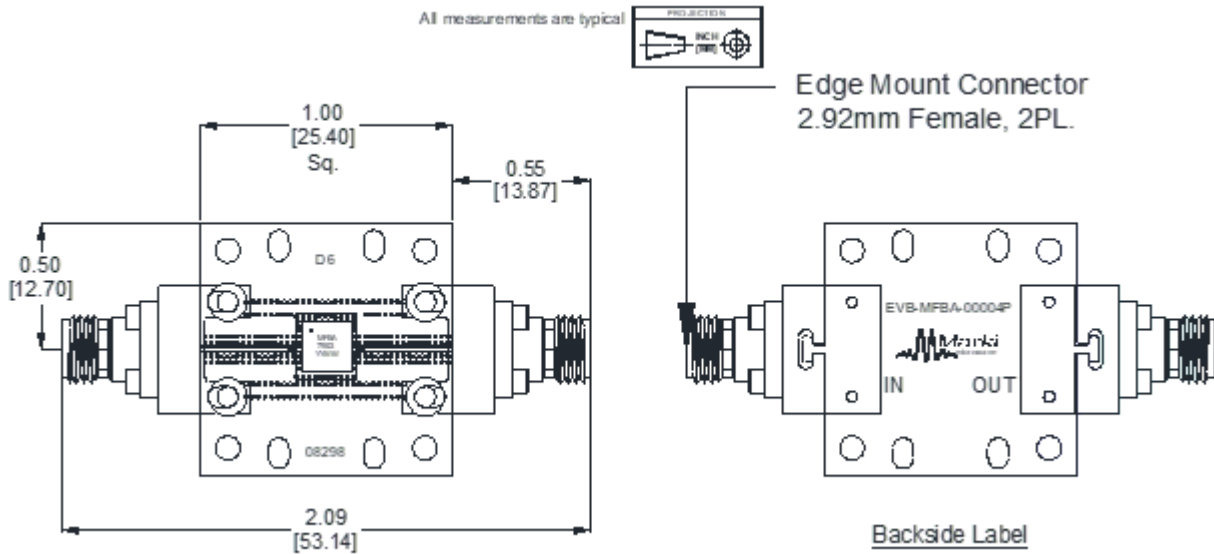

DISCLAIMER

MARKI MICROWAVE, INC., ("MARKI") PROVIDES TECHNICAL SPECIFICATIONS AND DATA (INCLUDING DATASHEETS), APPLICATION OR OTHER DESIGN ADVICE, WEB TOOLS, AND OTHER INFORMATION AND RESOURCES "AS IS" AND WITH ALL FAULTS. MARKI DISCLAIMS ALL WARRANTIES, EXPRESS OR IMPLIED, INCLUDING, WITHOUT LIMITATION, ANY IMPLIED WARRANTIES OF MERCHANTABILITY, FITNESS FOR A PARTICULAR PURPOSE, OR NON-INFRINGEMENT. These resources are intended for developers skilled in the art designing with Marki products. You are solely responsible for (1) selecting the appropriate products for your application, (2) designing, validating, and testing your application, and (3) ensuring your application meets applicable standards and other requirements. Marki makes no guarantee regarding the suitability of its products for any particular purpose, nor does Marki assume any liability whatsoever arising out of your use or application of any Marki product.

Marki grants you permission to use these resources only for development of an application that uses Marki products. Other reproduction or use of these resources is strictly prohibited. No license is granted to any other Marki intellectual property or to any third-party intellectual property. Marki reserves the right to make changes to the product(s) or information contained herein without notice.

MARKI MICROWAVE and T3 MIXER are trademarks or registered trademarks of Marki Microwave, Inc. All other trademarks used are the property of their respective owners.

© 2022, Marki Microwave, Inc