

## DPX-3-2 Diplexer

### DEVICE OVERVIEW

#### General Description

Available in either a connectorized or miniature surface mount package (0.240 inch x 0.150 inch), the DPX-3 is a low cost, high performance diplexer. The unique design offers high pass/low pass signal routing/multiplexing with excellent isolation. Passband insertion loss is less than 1.2 dB with rejection typically exceeding 25 dB. Besides being ideal for transmitter/receiver applications, the DPX-3 can also be used as an excellent non-reflective low pass (or high pass) filter for systems requiring broadband 50Ω impedance match (such as mixers).



[Download s-parameters here](#)

#### Features

- Low Insertion Loss
- Superior Repeatability
- Low Profile Miniaturized, Reflow Solderable Package Option
- User defined cross over frequencies available

#### Applications

- Reflectionless Filter Applications
- RF Transceivers

#### Functional Block Diagram

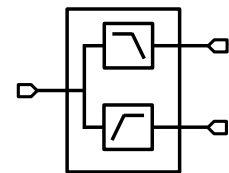

#### Part Ordering Options

Part Number	Description	Package	Green Status	Product Lifecycle	Export Classification
DPX-3-2	Diplexer	DPX	RoHS REACH	Released	EAR99
<u><a href="#">DPX-3-1</a></u>	Diplexer	DPX	RoHS REACH	Released	EAR99

## Table Of Contents

- **Device Overview**
  - General Description
  - Features
  - Applications
  - Functional Block Diagram
- **Port Configuration and Functions**
  - Port Diagram
  - Port Functions
- **Revision History**
- **Specifications**
  - Package Information
  - Electrical Specifications
  - Typical Performance Plots
- **Mechanical Data**
  - Outline Drawing
- **Footprint Image**

## Revision History

Revision Code	Revision Date	Comment
-	2012-11-29	Datasheet Initial Release
A	2025-07-20	Updated Port Functions Description Table

## Port Configuration and Functions

### Port Diagram

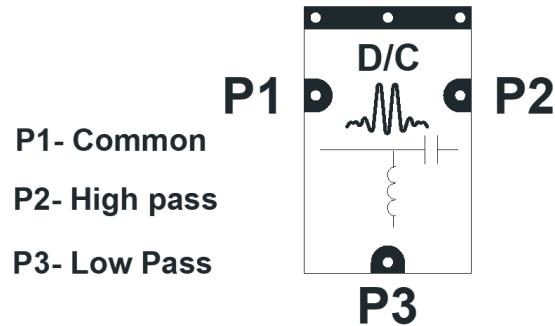

### Port Functions

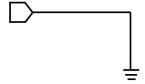
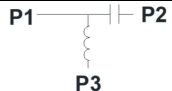
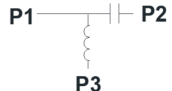
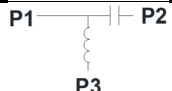
Port	Function	Description	Equivalent Circuit for Package
GND	Ground	DPX package ground is provided through the substrate and ground bond pads.	
Pin 1	Common/Input	Pin 1 is DC open to Pin 2 and short to Pin 3.	
Pin 2	High Pass Filter	Pin 2 is DC open to Pin 1 and Pin 3.	
Pin 3	Low Pass Filter	Pin 3 is DC short to Pin 1 and open to Pin 2.	

## Specifications

### Package Information

Parameter	Details	Rating
Dimensions	-	3.81 x 6.10 mm
Moisture Sensitivity Level	-	MSL 3

## Electrical Specifications

Specifications guaranteed from -55 to +100°C, measured in a 50Ω system.

Parameter	Test Conditions	Minimum Frequency (GHz)	Maximum Frequency (GHz)	Min	Typ	Max	Unit
30 dBc Low Pass Rejection Point	<1.5 GHz	-	1.5	25	30	-	dB
30 dBc Low Pass Rejection Point	<2.3 GHz	-	2.3	-	15	-	dB
Common Port Return Loss	<2.3 GHz	-	2.3	-	15	-	dB
Common Port Return Loss	4.2-8 GHz	4.2	8	-	15	-	dB
Cross Over Frequency	3.1 GHz	3.1	3.1	-	5	-	%
High Pass Filter, Pass Band Insertion Loss	4.2-8 GHz	4.2	8	-	0.7	1.4	dB
High Pass Filter, Pass Band Return Loss	4.2-8 GHz	4.2	8	-	15	-	dB
Isolation	<2.2 GHz	-	2.2	14	25	-	dB
Isolation	4.4-8GHz	4.4	8	14	25	-	dB
Low Pass Filter, Pass Band Insertion Loss	DC-2.3 GHz	0	2.3	-	0.7	1.4	dB
Low Pass Filter, Pass Band Return Loss	<2.3 GHz	-	2.3	-	15	-	dB
Low Pass Filter, Stop Band Rejection	4.2-4.8 GHz	4.2	4.8	-	15	-	dB
Low Pass Filter, Stop Band Rejection	4.8-8 GHz	4.8	8	15	20	-	dB
High Frequency Passband	-	-	-	4.2	-	8	GHz
Low Frequency Passband	-	-	-	0	-	2.3	GHz
RF Power	-	-	-	-	-	1	W

**Typical Performance Plots**

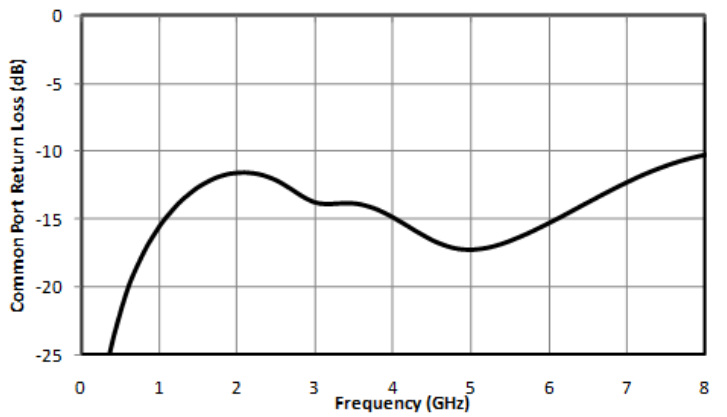
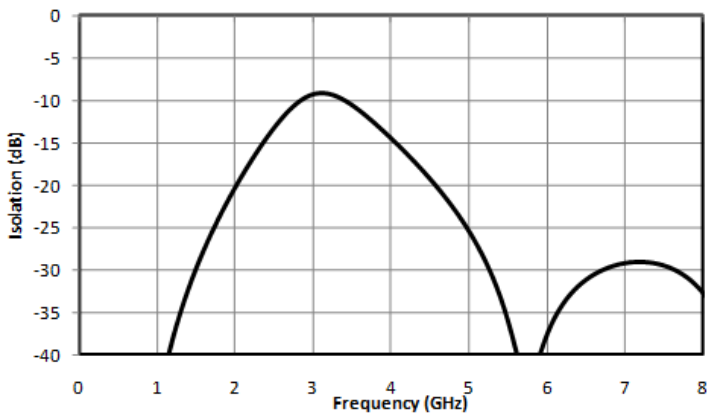
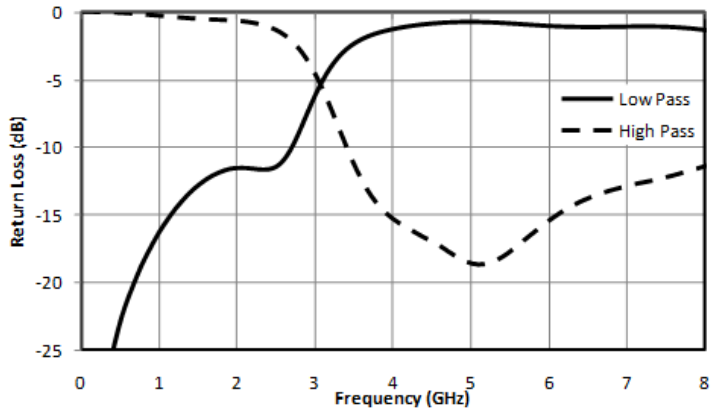
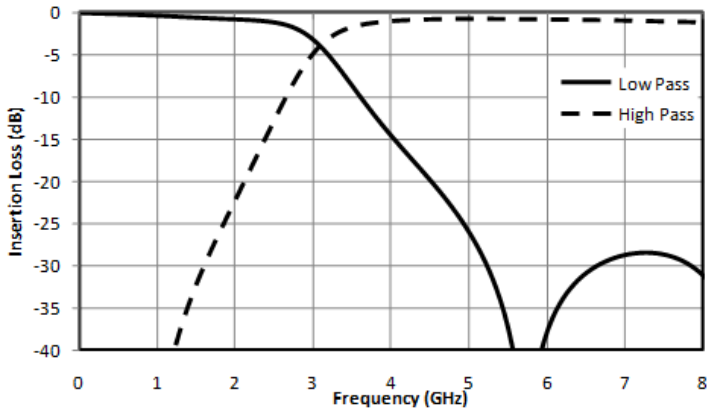

**Mechanical Data**

**Outline Drawing**

Download : [Outline 2D Drawing](#) | [Outline 3D Drawing](#) | [Outline 3D STP](#)

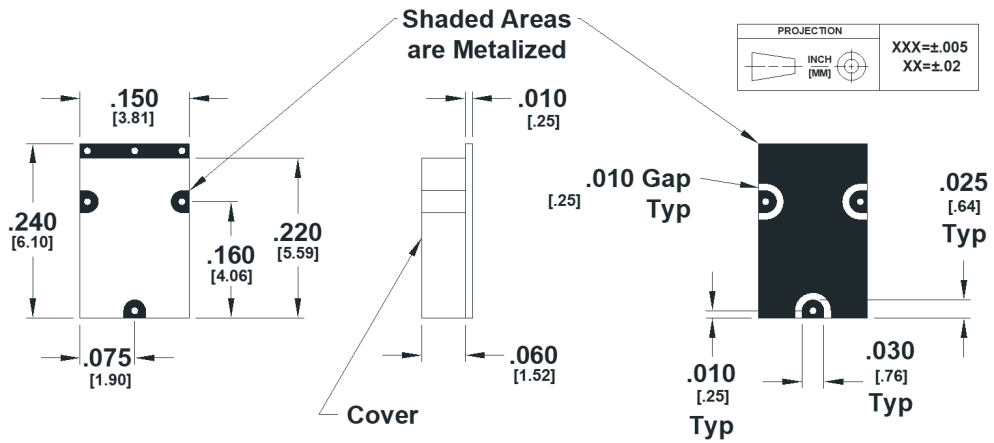

**Footprint Image**

Download : [Footprint Drawing](#)

**BTSM/PDSM Surface-Mount System Circuit Footprint**

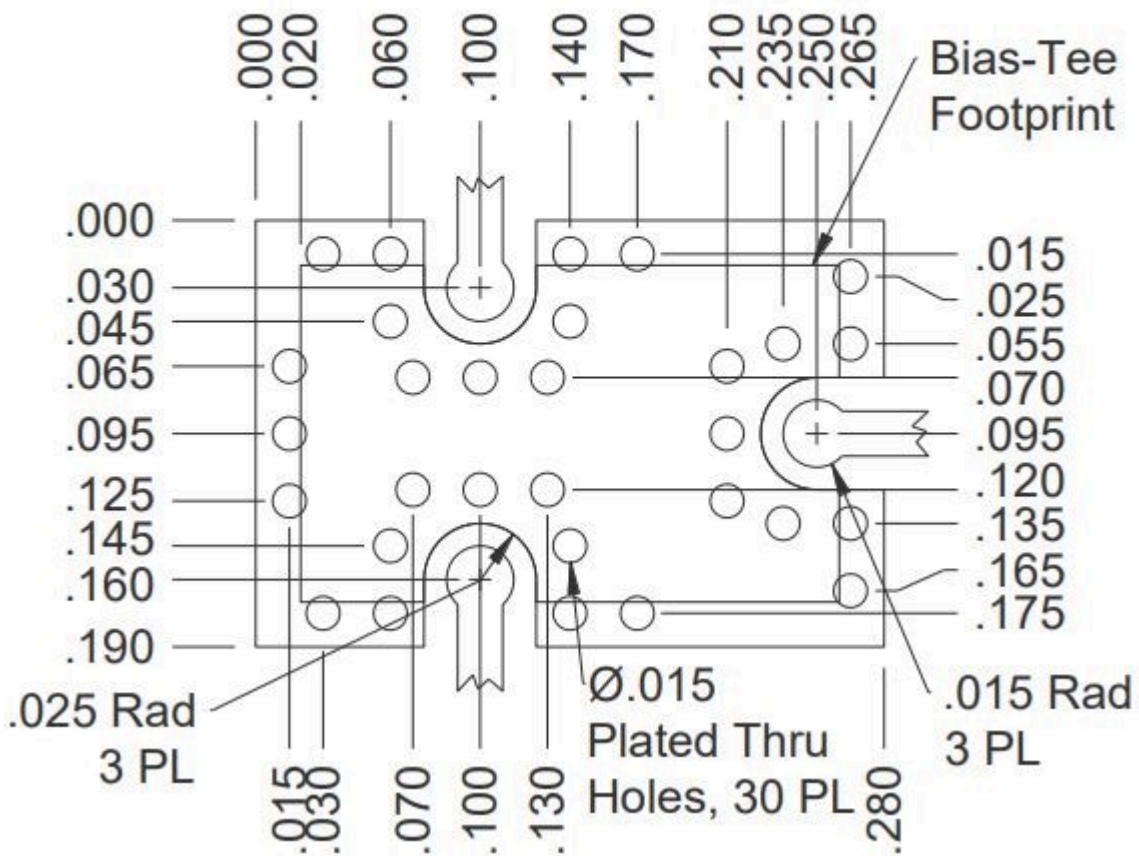

#### **DISCLAIMER**

MARKI MICROWAVE, INC., ("MARKI") PROVIDES TECHNICAL SPECIFICATIONS AND DATA (INCLUDING DATASHEETS), APPLICATION OR OTHER DESIGN ADVICE, WEB TOOLS, AND OTHER INFORMATION AND RESOURCES "AS IS" AND WITH ALL FAULTS. MARKI DISCLAIMS ALL WARRANTIES, EXPRESS OR IMPLIED, INCLUDING, WITHOUT LIMITATION, ANY IMPLIED WARRANTIES OF MERCHANTABILITY, FITNESS FOR A PARTICULAR PURPOSE, OR NON-INFRINGEMENT. These resources are intended for developers skilled in the art designing with Marki products. You are solely responsible for (1) selecting the appropriate products for your application, (2) designing, validating, and testing your application, and (3) ensuring your application meets applicable standards and other requirements. Marki makes no guarantee regarding the suitability of its products for any particular purpose, nor does Marki assume any liability whatsoever arising out of your use or application of any Marki product.

Marki grants you permission to use these resources only for development of an application that uses Marki products. Other reproduction or use of these resources is strictly prohibited. No license is granted to any other Marki intellectual property or to any third-party intellectual property. Marki reserves the right to make changes to the product(s) or information contained herein without notice.

MARKI MICROWAVE and T3 MIXER are trademarks or registered trademarks of Marki Microwave, Inc. All other trademarks used are the property of their respective owners.

© 2012, 2025, Marki Microwave, Inc