

# MEQ10-26AS

## Passive GaAs MMIC 26.5 GHz Equalizer

### DEVICE OVERVIEW

#### General Description

The MEQ10-26AS passive MMIC equalizer is an ideal solution for compensating for low pass filtering effects in RF/microwave and high speed digital systems. This equalizer provides positive slope from DC to 26.5 GHz with a DC attenuation value of 10dB and a 50-ohm match maintained over the entire operating range. GaAs MMIC technology provides consistent unit-to-unit performance in a small, low cost form factor. Contact the factory for connectorized versions of our other MEQ products.

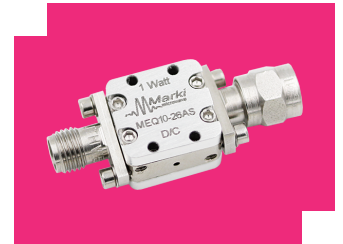

[Download s-parameters here](#)

#### Features

- DC attenuation of 10dB
- Typical Insertion Loss 0.7 dB at 26.5 GHz
- Return loss: typical 20 dB over the entire band
- Bidirectional

#### Applications

- RF Transceivers
- High-Speed Data
- Telecom
- Cable Loss Compensation
- Amplifier Compensation

#### Functional Block Diagram



#### Part Ordering Options

Part Number	Description	Package	Connectors	Green Status	Product Lifecycle	Export Classification
MEQ10-26AS	Passive GaAs MMIC 26.5 GHz Equalizer	S	<u>Standard</u>	REACH RoHS	Released	EAR99

**Table Of Contents**

- **Device Overview**
  - General Description
  - Features
  - Applications
  - Functional Block Diagram
- **Port Configuration and Functions**
  - Port Diagram
  - Port Functions
- **Revision History**
- **Specifications**
  - Absolute Maximum Ratings
  - Package Information
  - Electrical Specifications
  - Typical Performance Plots
- **Mechanical Data**
  - Outline Drawing

**Revision History**

Revision Code	Revision Date	Comment
-	2019-08-01	Datasheet Initial Release

## Port Configuration and Functions

### Port Diagram

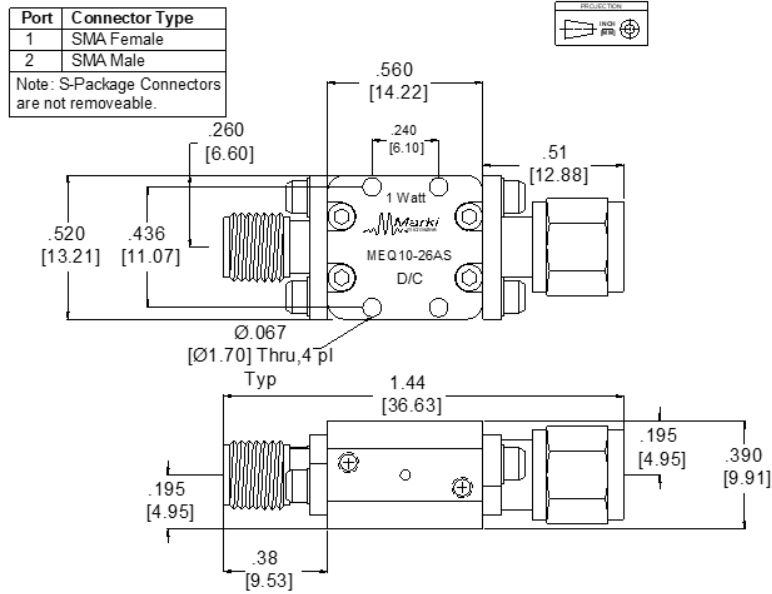

### Port Functions

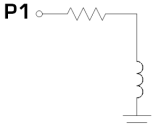
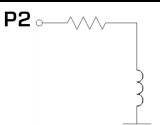
Port	Function	Connector Type	Description	Equivalent Circuit for Package
Pad	Ground	-	S package ground provided through metal housing and outer coax conductor.	<b>GND</b> 
Port 1	Input/Output	SMAF	Port 1 is DC connected to ground through a resistor. DC block is required if voltage present.	<b>P1</b> 
Port 2	Input/Output	SMAM	Port 2 is DC connected to ground through a resistor. DC block is required if voltage present.	<b>P2</b> 

**Specifications**

**Absolute Maximum Ratings**

The Absolute Maximum Ratings indicate limits beyond which damage may occur to the device. If these limits are exceeded, the device may be inoperable or have a reduced lifetime.

Parameter	Maximum Rating	Unit
Maximum Operating Temperature	100	°C
Maximum Storage Temperature	125	°C
Minimum Operating Temperature	-55	°C
Minimum Storage Temperature	-65	°C
Port 1 DC Current	40	mA
Port 2 DC Current	40	mA
Power Handling, at any Port	30	dBm

**Package Information**

Parameter	Details	Rating
ESD	250 to < 500 Volts	HBM Class 1A
Weight	Package name: S	11.5g
Dimensions	-	14.22 x 13.21 mm

**Electrical Specifications**

The electrical specifications apply at TA=+25°C in a 50Ω system. Typical data shown is for the equalizer in a S package with a sine wave input applied to port 1.

Parameter	Test Conditions	Minimum Frequency (GHz)	Maximum Frequency (GHz)	Min	Typ	Max	Unit
Impedance	-	-	-	-	50	-	Ω
Insertion Loss	-	10	10	-	3	-	dB
Insertion Loss	-	18	18	-	1.2	-	dB
Insertion Loss	-	26.5	26.5	-	0.7	1.5	dB
Insertion Loss at DC	-	0	0	-	10	-	dB
Return Loss	-	0	26.5	16	20	-	dB

**Typical Performance Plots**

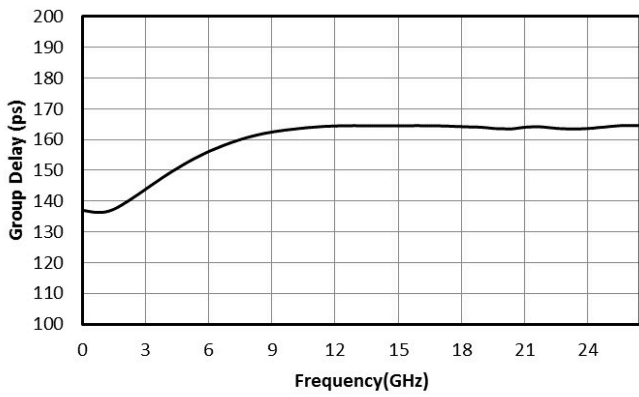
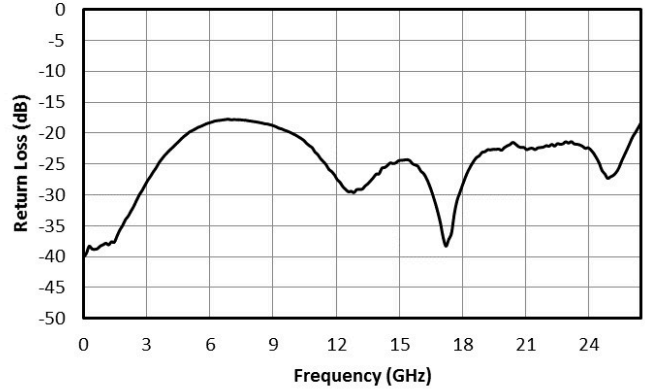
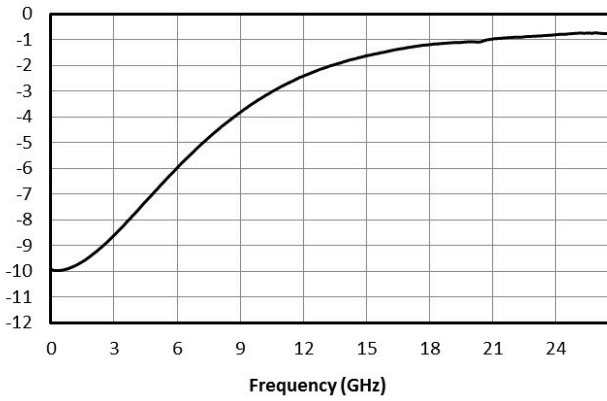

**Mechanical Data**

**Outline Drawing**

Download : [Outline 2D Drawing](#) | [Outline 3D Drawing](#) | [Outline 3D STP](#)

Port	Connector Type
1	SMA Female
2	SMA Male

Note: S-Package Connectors are not removeable.

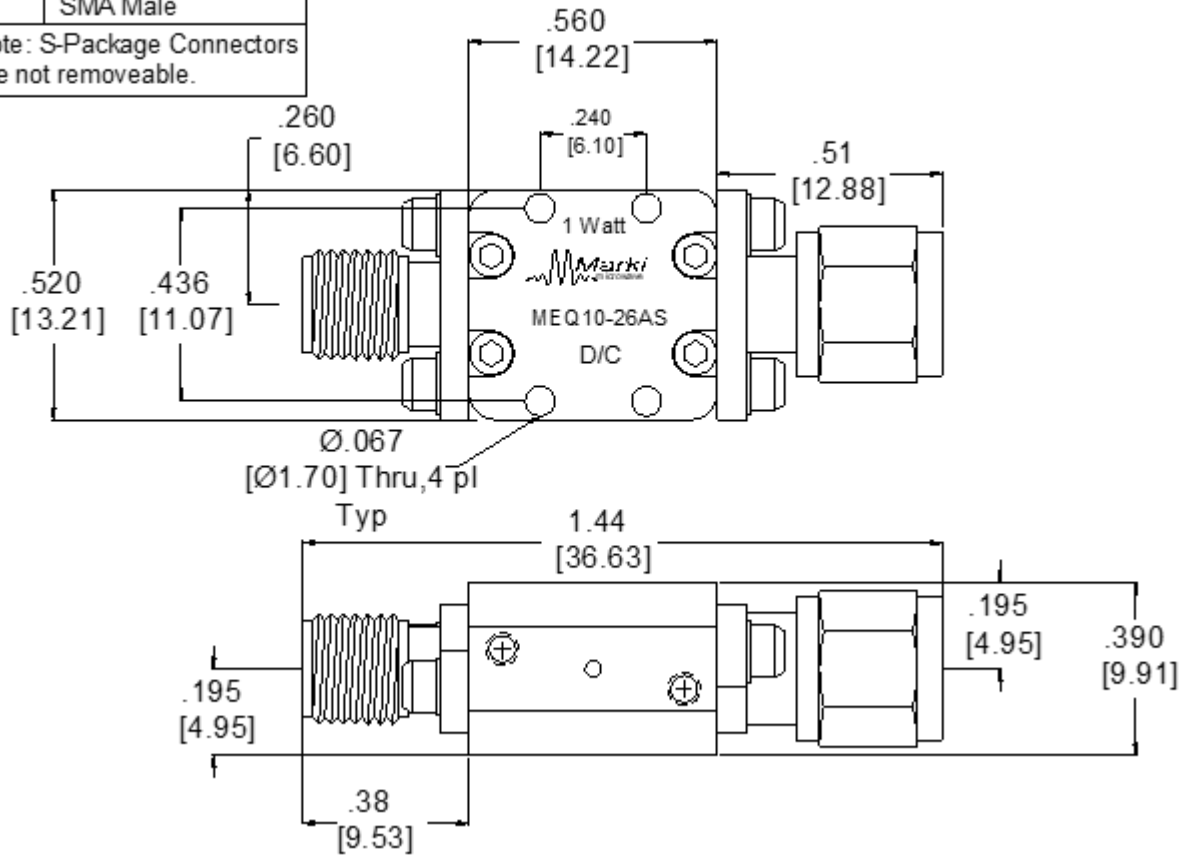

**DISCLAIMER**

MARKI MICROWAVE, INC., ("MARKI") PROVIDES TECHNICAL SPECIFICATIONS AND DATA (INCLUDING DATASHEETS), APPLICATION OR OTHER DESIGN ADVICE, WEB TOOLS, AND OTHER INFORMATION AND RESOURCES "AS IS" AND WITH ALL FAULTS. MARKI DISCLAIMS ALL WARRANTIES, EXPRESS OR IMPLIED, INCLUDING, WITHOUT LIMITATION, ANY IMPLIED WARRANTIES OF MERCHANTABILITY, FITNESS FOR A PARTICULAR PURPOSE, OR NON-INFRINGEMENT. These resources are intended for developers skilled in the art designing with Marki products. You are solely responsible for (1) selecting the appropriate products for your application, (2) designing, validating, and testing your application, and (3) ensuring your application meets applicable standards and other requirements. Marki makes no guarantee regarding the suitability of its products for any particular purpose, nor does Marki assume any liability whatsoever arising out of your use or application of any Marki product.

Marki grants you permission to use these resources only for development of an application that uses Marki products. Other reproduction or use of these resources is strictly prohibited. No license is granted to any other Marki intellectual property or to any third-party intellectual property. Marki reserves the right to make changes to the product(s) or information contained herein without notice.

MARKI MICROWAVE and T3 MIXER are trademarks or registered trademarks of Marki Microwave, Inc. All other trademarks used are the property of their respective owners.

© 2019, Marki Microwave, Inc