

# MMIQ-0626LCH-2

## Low LO Drive Passive GaAs MMIC IQ Mixer

### DEVICE OVERVIEW

#### General Description

MMIQ-0626L is a low LO drive, passive GaAs MMIC IQ mixer that operates down to an unrivaled +3 dBm LO drive level. This is an ultra-broadband mixer spanning 6 to 26 GHz on the RF and LO ports with an IF from DC to 6 GHz. Up to 40 dB of image rejection is available due to the excellent phase and amplitude balance of its on-chip LO quadrature hybrid. Both wire bondable die and connectorized modules are available.

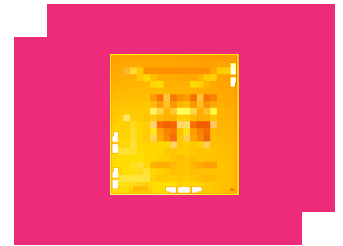

#### Features

N/A

#### Applications

- Single Sideband and Image Rejection Mixing
- IQ Modulation / Demodulation
- Vector Amplitude Modulation
- Band Shifting

#### Functional Block Diagram

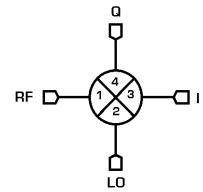

#### Part Ordering Options

Part Number	Description	Package	Connectors	Green Status	Product Lifecycle	Export Classification
<a href="#">MMIQ-0626LS</a>	Low LO Drive Passive GaAs MMIC IQ Mixer	S	<a href="#">Standard</a>	REACH RoHS	Released	EAR99
MMIQ-0626LCH-2	Low LO Drive Passive GaAs MMIC IQ Mixer	CH	-	REACH RoHS	Released	EAR99

**Table Of Contents**

- **Device Overview**
  - General Description
  - Features
  - Applications
  - Functional Block Diagram
- **Port Configuration and Functions**
  - Port Diagram
  - Port Functions
- **Revision History**
- **Specifications**
  - Absolute Maximum Ratings
  - Package Information
  - Recommended Operating Conditions
  - Sequencing Requirements
  - Electrical Specifications
  - Typical Performance Plots
  - Typical Performance Plots: IP3
  - Typical Performance Plots: P1dB
  - Typical Performance Plots: LO Harmonic Isolation
  - Typical Performance Plots: Band Shifter
  - Typical Performance Plots: Vector Modulator
  - MMIQ-0626LS Typical Performance Plots
  - MMIQ-0626LS Typical Performance Plots: IP3
  - MMIQ-0626LS Typical Performance Plots: P1dB
  - MMIQ-0626LS Typical Performance Plots: LO Harmonic Isolation
  - MMIQ-0626LS Typical Performance Plots: Band Shifter
  - MMIQ-0626LS Typical Performance Plots: Vector Modulator
  - Spur Tables
- **Die Mounting Recommendations**
  - Mounting and Bounding Recommendations
- **Operation**
  - Application Circuit
  - Application Circuit Description
- **Mechanical Data**
  - Outline Drawing

**Revision History**

Revision Code	Revision Date	Comment
-	2017-08-01	Datasheet Initial Release
A	2017-09-01	Minor Clarification/Text Changes
B	2017-10-01	Correction to spurious response
C	2018-07-01	Correction to OIP3 Graph
D	2019-08-01	Changed I/Q Max Current Rating
E	2019-10-01	Updated Max Power Handling
F	2022-08-01	Updated I/Q Port Diagrams



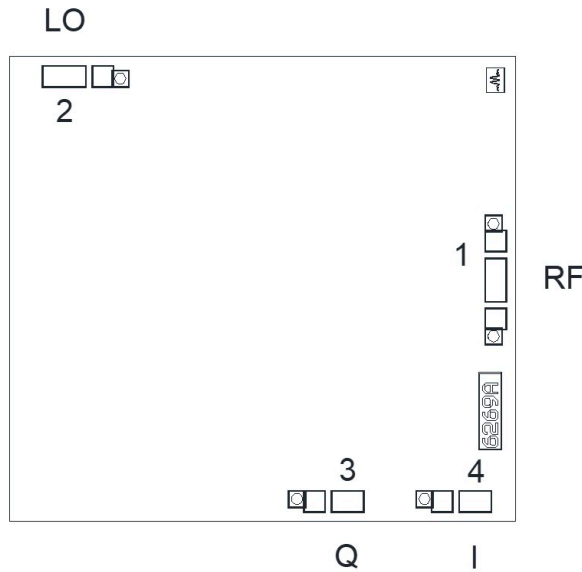

## Port Configuration and Functions

### Port Diagram

A top-down view of the MMIQ-0626L's CH-2 package outline drawing is shown below. The mixer may be operated as either a downconverter or an upconverter. Use of the RF or IF as the input or output port will depend on the application. See Application Information for input and output port configuration for common applications.

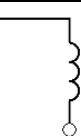

### Port Functions

Port	Function	Description	Equivalent Circuit for Package
GND	Ground	CH package ground path is taken through the substrate.	<b>GND</b> 
Port 1	RF Input / Output	Port 1 is DC short and AC matched to 50Ω over the specified RF frequency range.	<b>P1</b> 
Port 2	LO Input	Port 2 is DC open and AC matched to 50Ω over the specified LO frequency range.	<b>P2</b> 
Port 3	Q Input / Output	Port 3 is diode coupled and AC matched to 50Ω over the specified I port frequency range.	<b>P3</b> 
Port 4	I Input / Output	Port 4 is diode coupled and AC matched to 50Ω over the specified Q port frequency range.	<b>P4</b> 

## Specifications

### Absolute Maximum Ratings

The Absolute Maximum Ratings indicate limits beyond which damage may occur to the device. If these limits are exceeded, the device may be inoperable or have a reduced lifetime.

Parameter	Maximum Rating	Unit
Maximum Operating Temperature	100	°C
Maximum Storage Temperature	125	°C
Minimum Operating Temperature	-55	°C
Minimum Storage Temperature	-65	°C
Port 3 DC Current	30	mA
Port 4 DC Current	30	mA
Power Handling, at any Port	26	dBm

### Package Information

Parameter	Details	Rating
ESD	250 to < 500 Volts	HBM Class 1A
Dimensions	-	2.28x2.09mm

### Recommended Operating Conditions

The Recommended Operating Conditions indicate the limits, inside which the device should be operated, to guarantee the performance given in Electrical Specifications. Operating outside these limits may not necessarily cause damage to the device, but the performance may degrade outside the limits of the electrical specifications. For limits, above which damage may occur, see Absolute Maximum Ratings.

Parameter	Min	Nominal	Max	Unit
LO Input Power	3	9	13	dBm
Ambient Temperature	-55	25	100	°C
RF/IF Input Power	-	-	2	dBm

### Sequencing Requirements

There is no requirement to apply power to the ports in a specific order. However, it is recommended to provide a 50Ω termination to each port before applying power. This is a passive diode mixer that requires no DC bias.

**Electrical Specifications**

The electrical specifications apply at TA=+25°C in a 50Ω system. Typical data shown is for a down conversion application with a +9dBm sine wave LO input. Min and Max limits apply only to our connectorized units and are guaranteed at TA=+25°C. All bare die are 100% DC tested and visually inspected.

Parameter	Test Conditions	Minimum Frequency (GHz)	Maximum Frequency (GHz)	Min	Typ	Max	Unit
Amplitude Balance	-	-	-	-	0.5	-	dB
Conversion Loss <sup>1</sup>	RF/LO = 24 - 26 GHz I = DC - 0.2 GHz	24	26	-	14	17	dB
Conversion Loss <sup>2</sup>	RF/LO = 24 - 26 GHz Q = DC - 0.2 GHz	24	26	-	13	16	dB
Conversion Loss <sup>3</sup>	RF/LO = 6 - 24 GHz I = DC - 0.2 GHz	6	24	-	12	15	dB
Conversion Loss <sup>4</sup>	RF/LO = 6 - 24 GHz Q = DC - 0.2 GHz	6	24	-	12	15	dB
Conversion Loss <sup>5</sup>	RF/LO = 6 - 26 GHz I = 0.2 - 6 GHz	6	26	-	14	-	dB
Conversion Loss <sup>6</sup>	RF/LO = 6 - 26 GHz Q = 0.2 - 6 GHz	6	26	-	14	-	dB
IF Frequency Range	-	-	-	0	-	6	GHz
Image Rejection <sup>7</sup>	RF/LO = 6 - 26 GHz I+Q = DC - 0.2 GHz	6	26	-	35	-	dBc
Input 1 dB Gain Compression Point, I	-	-	-	-	6.1	-	dBm
Input 1 dB Gain Compression Point, Q	-	-	-	-	6.1	-	dBm
Input IP3 <sup>8</sup>	RF/LO = 6 - 26 GHz I = DC - 0.2 GHz	6	26	-	14.2	-	dBm
Isolation, LO to IF	IF/LO = 6 - 26 GHz	6	26	-	50	-	dB
Isolation, LO to RF	RF/LO = 6 - 26 GHz	6	26	-	41	-	dB
Isolation, RF to IF	RF/IF = 6 - 26 GHz	6	26	-	36	-	dB
LO Frequency Range	-	-	-	6	-	26	GHz
Noise Figure <sup>9</sup>	RF/LO = 6 - 24 GHz I = DC - 0.2 GHz	6	24	-	12	-	dB
Noise Figure <sup>10</sup>	RF/LO = 6 - 24 GHz Q = DC - 0.2 GHz	6	24	-	12	-	dB
Phase Balance	-	-	-	-	2	-	°
Q (Port 3) Frequency Range	-	-	-	0	-	6	GHz
RF Frequency Range	-	-	-	6	-	26	GHz

[1][2][3][4][5][6] Measured as an I/Q down converter. (i.e., I and Q powers are not combined)

[7] Image Rejection and Single sideband performance plots are defined by the upper sideband (USB) or lower sideband (LSB) with respect to the LO signal. Plots are defined by which sideband is selected by the external IF quadrature hybrid.

[8] Typical IIP3 measured with I and Q ports combined with an external quadrature hybrid coupler.

[9][10] Mixer Noise Figure typically measures within 0.5 dB of conversion loss for IF frequencies greater than 5 MHz.

**Typical Performance Plots**

The test conditions and frequency plan below applies to all following sections, unless otherwise specified.

Parameter		Port	Start	Nominal	Stop	Units
RF Input Frequency		1	0		30	GHz
RF Input Power			-10			dBm
LO Input Frequency		2	0.091		30.091	GHz
LO Input Power			+9			dBm
IF Output Frequency	Q	3		91		MHz
	I	4		91		
	I+Q <sup>7</sup>	3+4		91		
T <sub>A</sub> , Ambient Temperature				+25		°C
Z <sub>0</sub> , System Impedance				50		Ω

I output means that the IF output signal is measured at the I port of the mixer and the Q port is loaded. Q output means the IF output signal is measured at the Q port of the mixer while the I port is loaded.

<sup>7</sup> I+Q measurements taken with an external quadrature hybrid attached to the I and Q ports of the mixer. Orientation depends on up conversion or down conversion measurement.

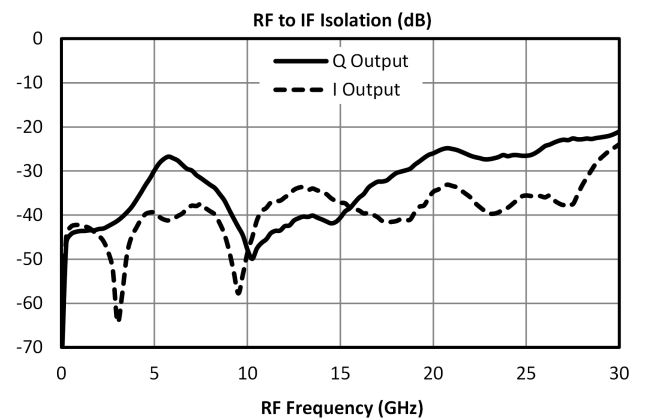
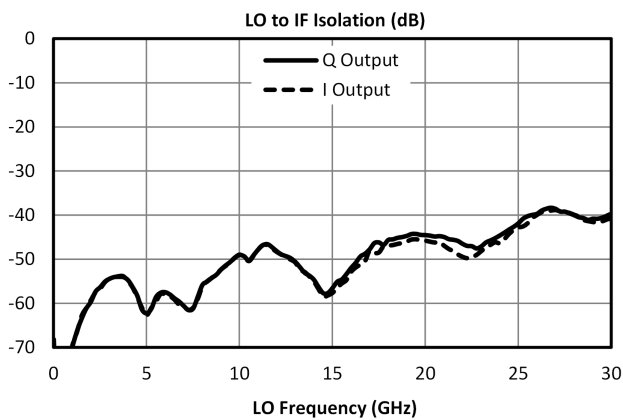
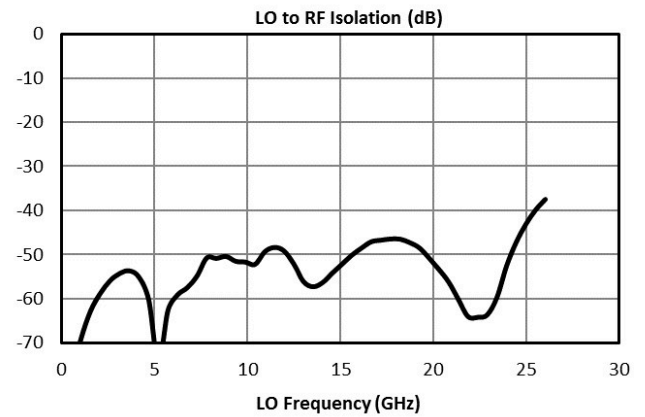
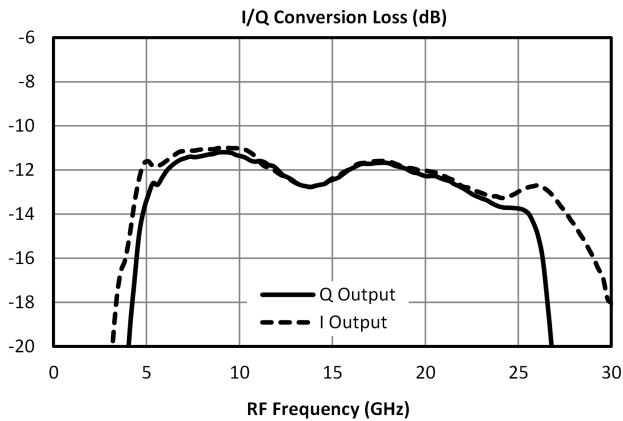

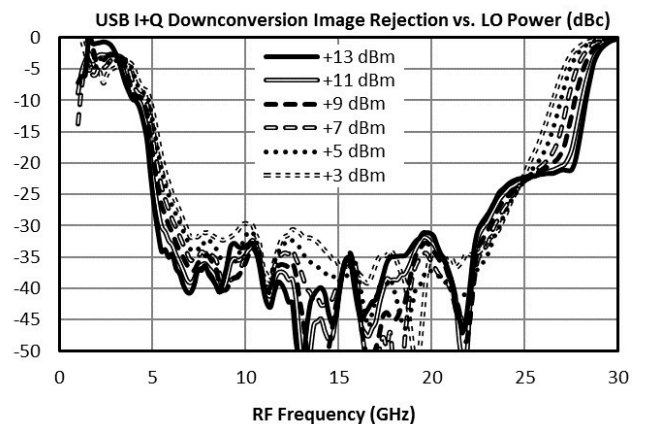
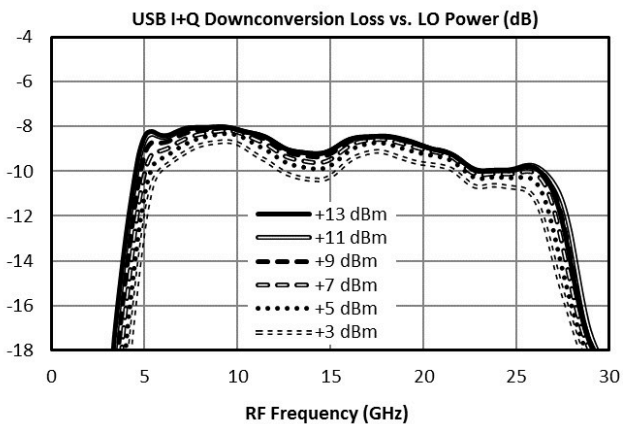
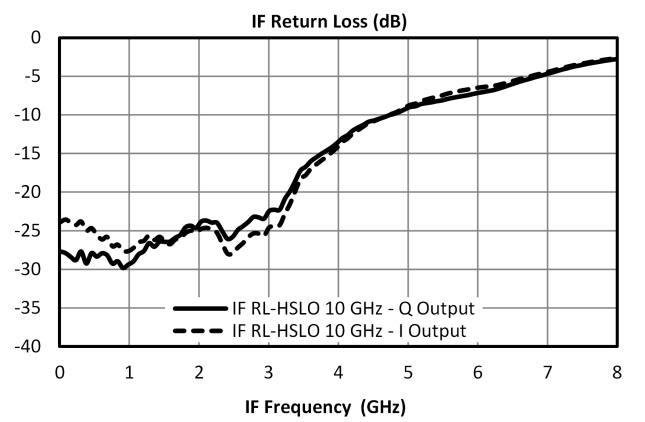
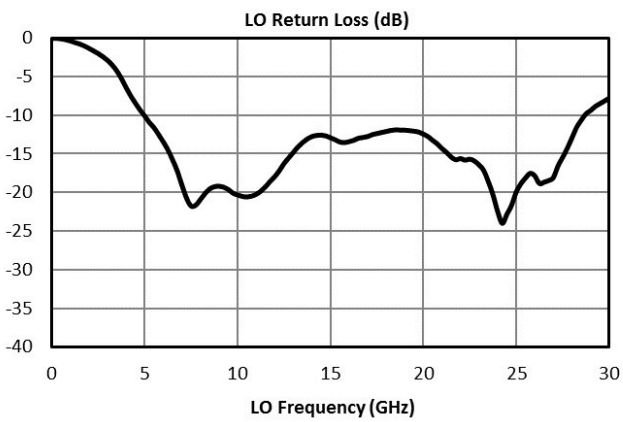
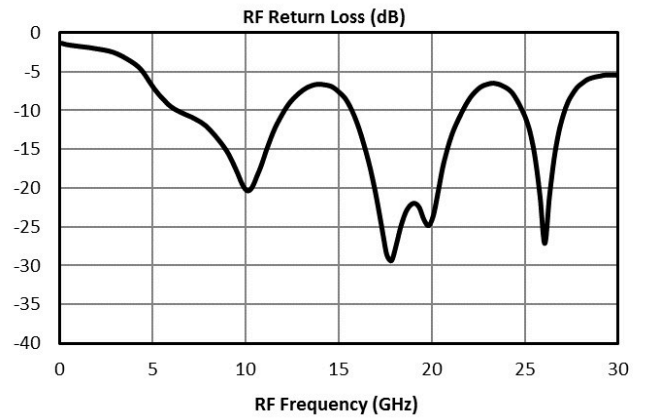
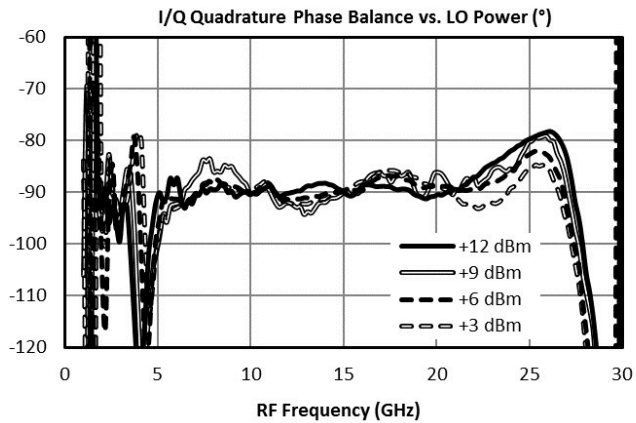
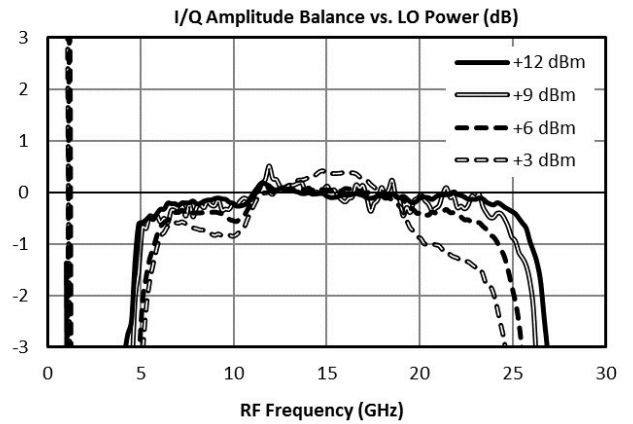
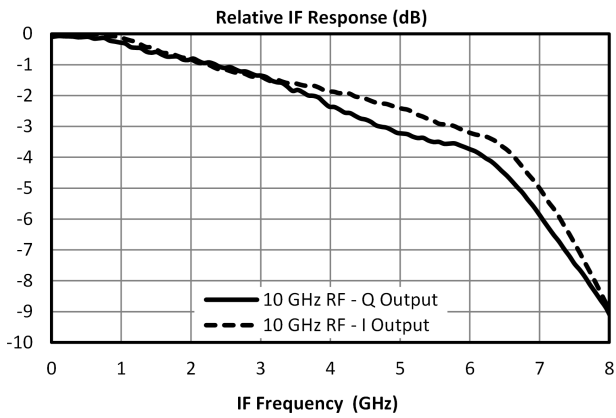

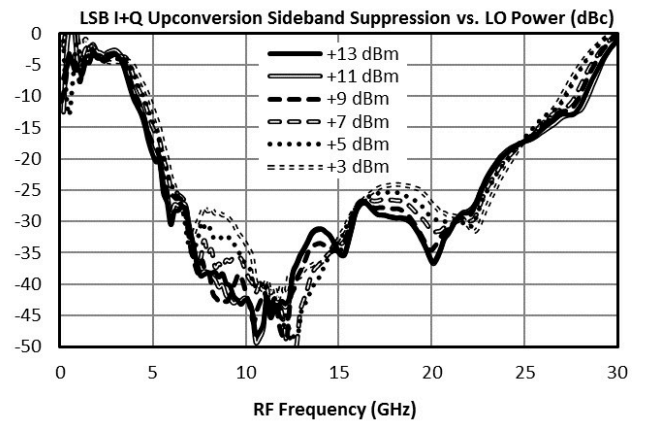
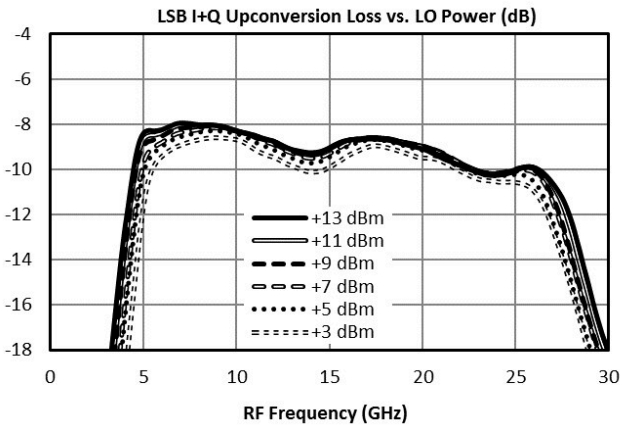
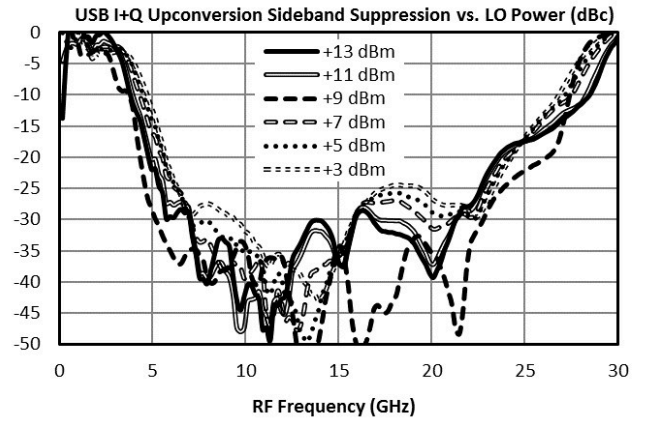
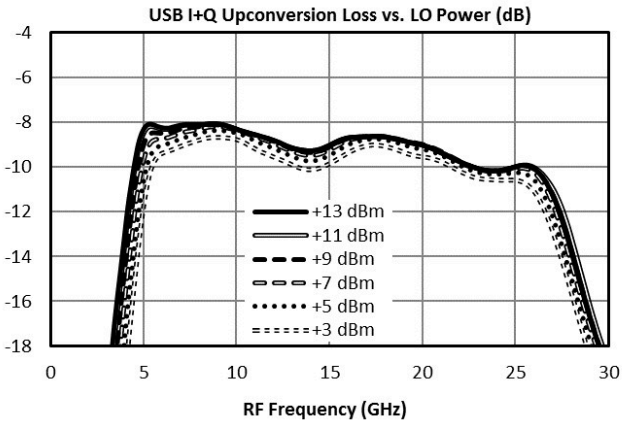
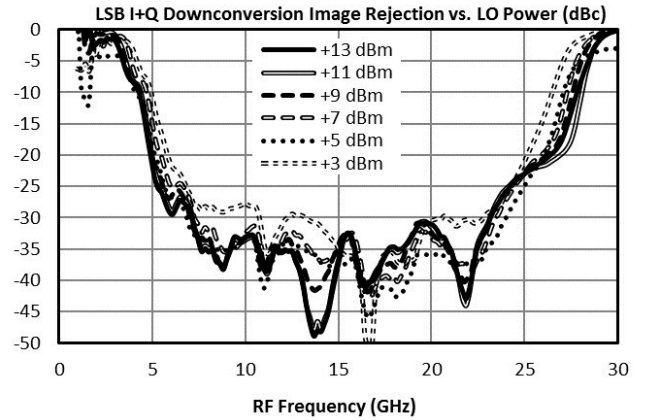
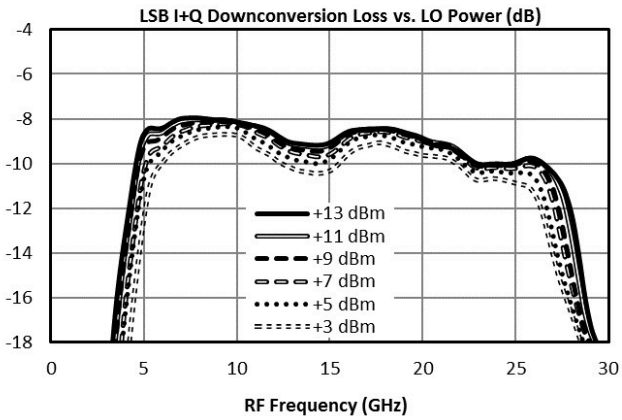

### Typical Performance Plots: IP3

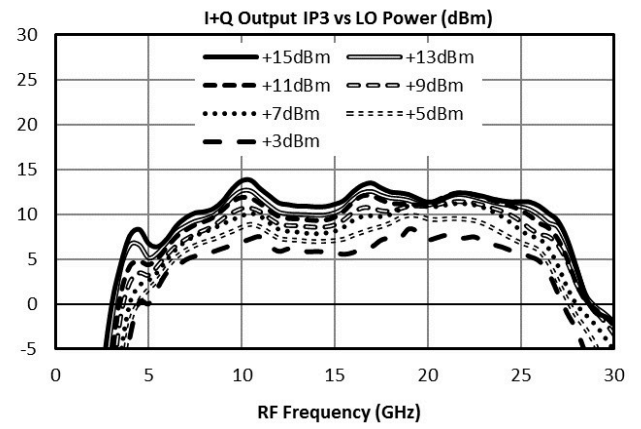
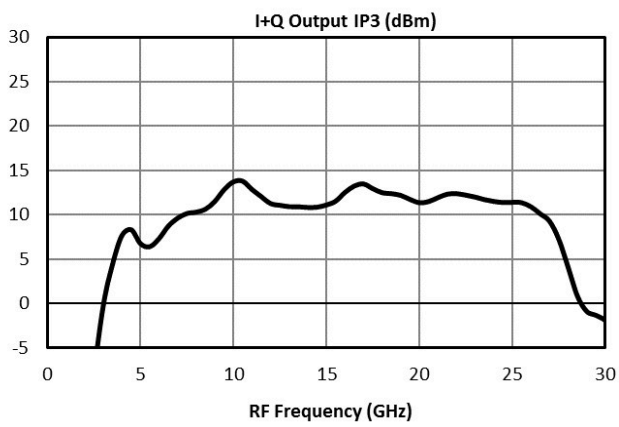
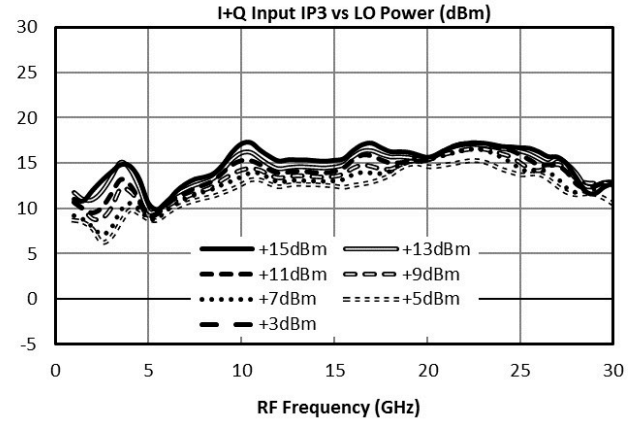
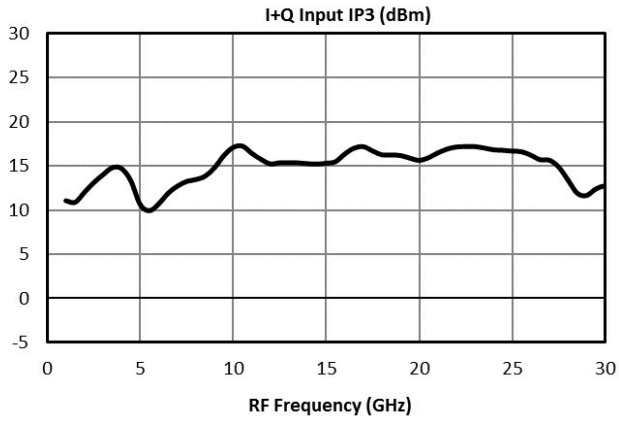

**Typical Performance Plots: P1dB**

Input 1dB compression point (P1dB) plots are taken with the following test conditions and frequency plan:

Parameter		Port	Start	Nominal	Stop	Units
RF Input Frequency		1		10		GHz
RF Input Power			-4		+10	dBm
LO Input Frequency		2		10.091		GHz
LO Input Power			+3	+9	+17	dBm
IF Output Frequency	Q	3		91		MHz
	I	4		91		
$T_A$ , Ambient Temperature				+25		°C
$Z_0$ , System Impedance				50		$\Omega$

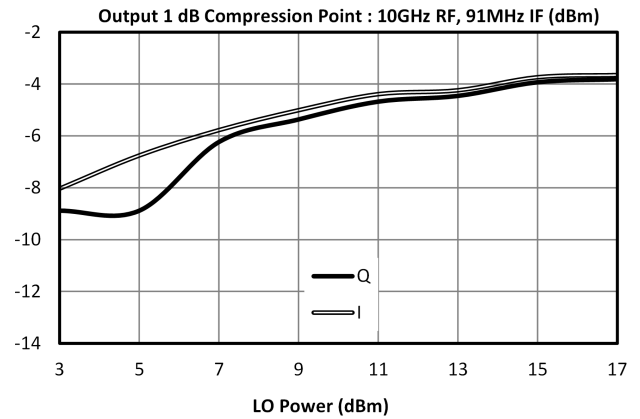
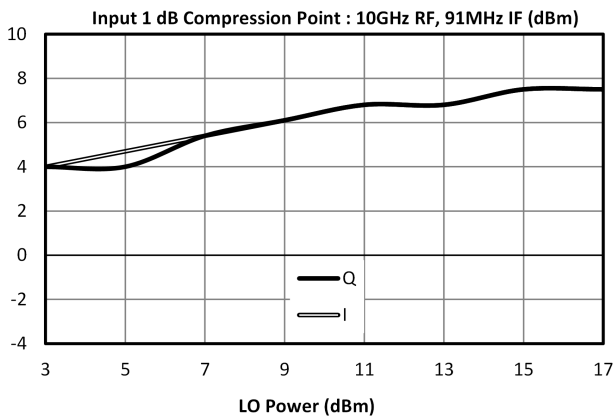

**Typical Performance Plots: LO Harmonic Isolation**

LO Harmonic Isolation plots are taken with the following test conditions and based on the following fundamental input signal frequency plan:

Parameter	Port	Start	Nominal	Stop	Units
RF Input Frequency	1	0		30	GHz
RF Input Power			-10		dBm
LO Input Frequency	2	0.091		30.091	GHz
LO Input Power				+9	
IF Output Frequency	3		91		MHz
	4		91		
$T_A$ , Ambient Temperature			+25		$^{\circ}\text{C}$
$Z_0$ , System Impedance			50		$\Omega$

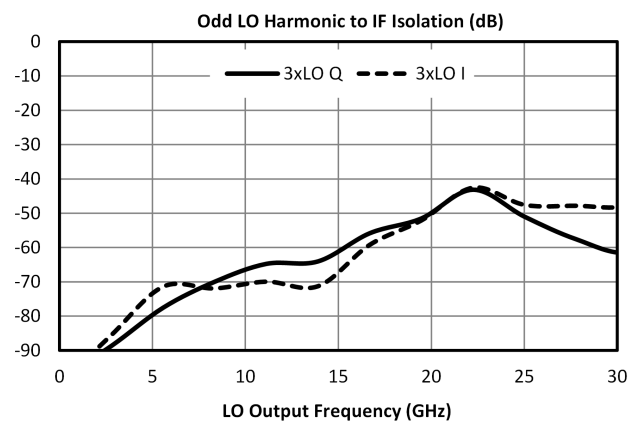
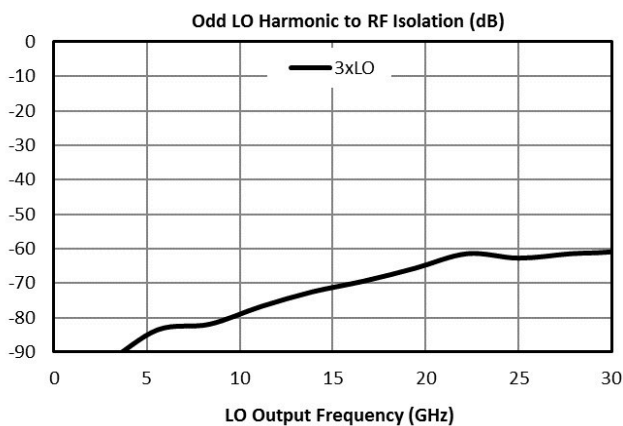
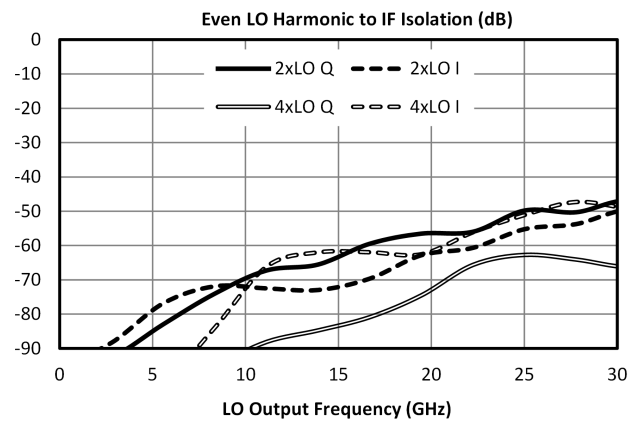
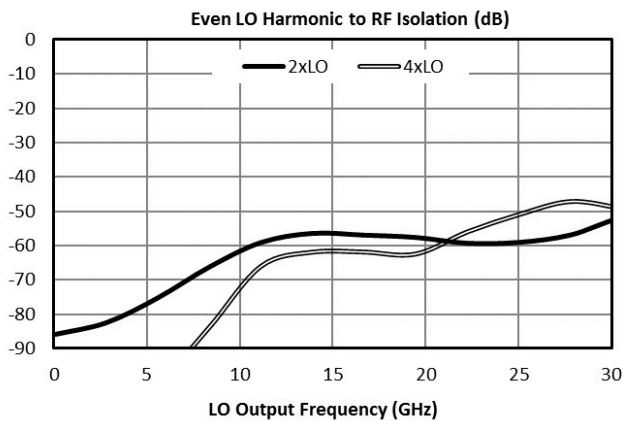

**Typical Performance Plots: Band Shifter**

Band Shifter performance plots are taken with the following test conditions and frequency plan:

Parameter	Port	Start	Nominal	Stop	Units
IF Input Frequency	2		See Plot		GHz
IF Input Power	2		-10		dBm
LO Input Frequency <sup>9</sup>	3+4	0.7		15	GHz
LO Input Power	3+4		+9		dBm
RF Output Frequency	1	IF+0.7		IF+15	GHz
T <sub>A</sub> , Ambient Temperature			+25		°C
Z <sub>0</sub> , System Impedance			50		Ω

Band shifter utilizes the mixer in a unique configuration with a low frequency LO signal. Refer to the Application Information section for more details.

<sup>9</sup> Low frequency LO quadrature hybrid used to take data is the QH-0R714.

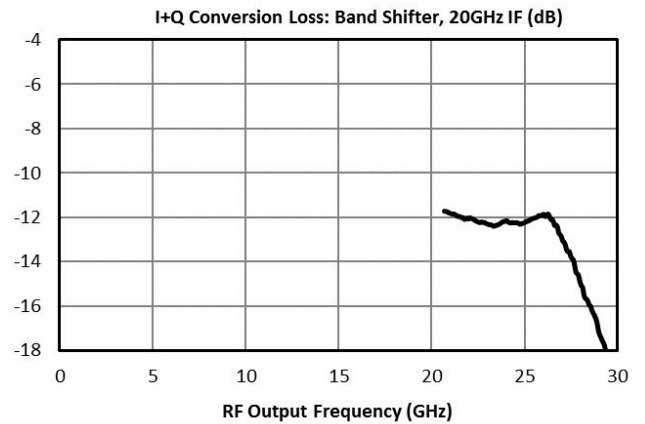
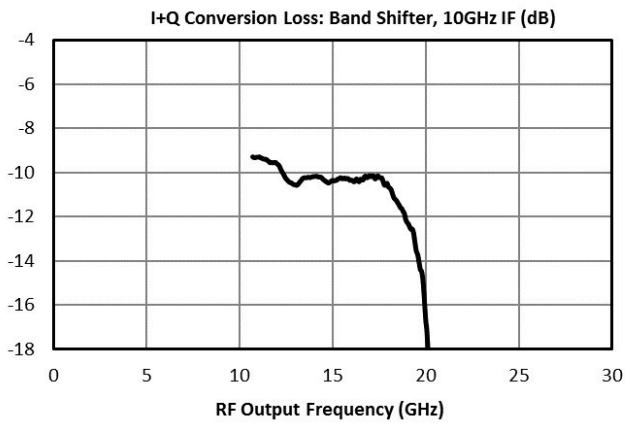

**Typical Performance Plots: Vector Modulator**

Vector Modulator performance plots are taken with the following test conditions and frequency plan:

Parameter	Port	Start	Nominal	Stop	Units
Input Frequency	2	0		30	GHz
Input Power			-10		dBm
I/Q Input Current	3		+19		mA
	4		+19		
Output Frequency	1	0		30	GHz
T <sub>A</sub> , Ambient Temperature			+25		°C
Z <sub>0</sub> , System Impedance			50		Ω

Nominal I/Q bias current given in the table to the right to tune a 10 GHz input signal's phase to 0°, 90°, 180°, or 270° at the port 1 RF output.

Phase Shift (°)	I Port 4 Input Current (mA)	Q Port 3 Input Current (mA)
0	+19	+19
90	-19	+3
180	-19	-19
270	+19	-3

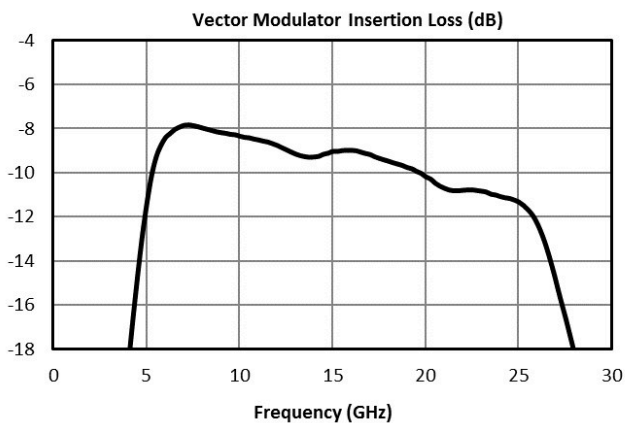

## MMIQ-0626LCH-2

### Low LO Drive Passive GaAs MMIC IQ Mixer

Vector Modulator Normalized Insertion Loss vs Phase: 10GHz (U)

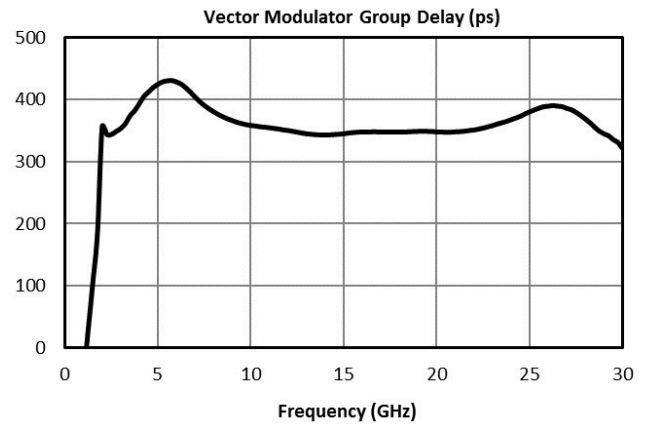
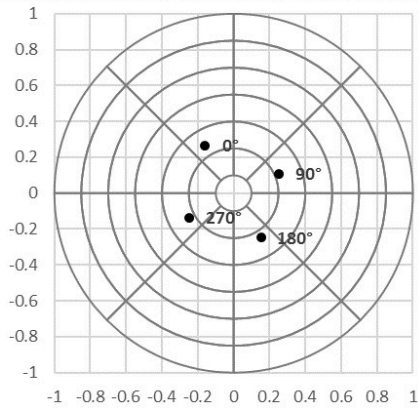

Vector Modulator Insertion Loss vs Phase: 10GHz (dB)

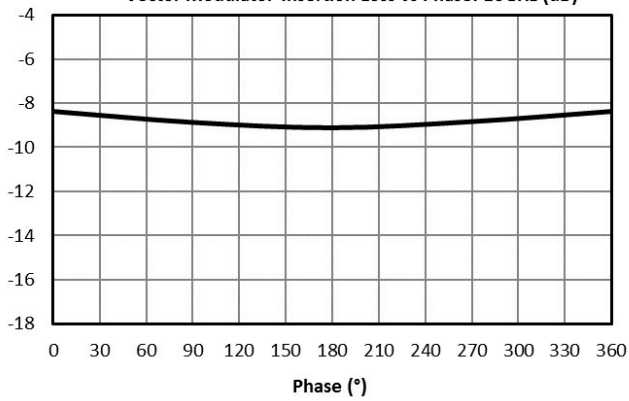

**MMIQ-0626LS - Typical Performance Plots**

The test conditions and frequency plan below applies to all following sections, unless otherwise specified.

Parameter	Port	Start	Nominal	Stop	Units
RF Input Frequency	1	0		30	GHz
RF Input Power			-10		dBm
LO Input Frequency	2	0.091		30.091	GHz
LO Input Power				+9	
IF Output Frequency	Q	3	91		MHz
	I	4	91		
	I+Q <sup>7</sup>	3+4	91		
T <sub>A</sub> , Ambient Temperature			+25		°C
Z <sub>0</sub> , System Impedance			50		Ω

I output means that the IF output signal is measured at the I port of the mixer and the Q port is loaded. Q output means the IF output signal is measured at the Q port of the mixer while the I port is loaded.

<sup>7</sup> I+Q measurements taken with an external quadrature hybrid attached to the I and Q ports of the mixer. Orientation depends on up conversion or down conversion measurement.

Performance plots for the connectorized module are shown for measurements where directly probed measurements of the die are unavailable. Note that the following measurements include losses from connectors and microstrip traces.

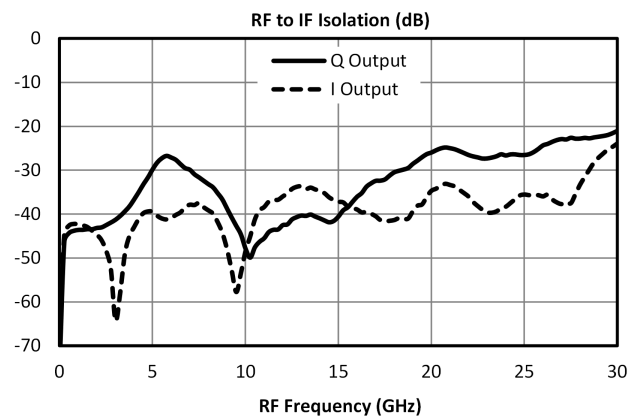
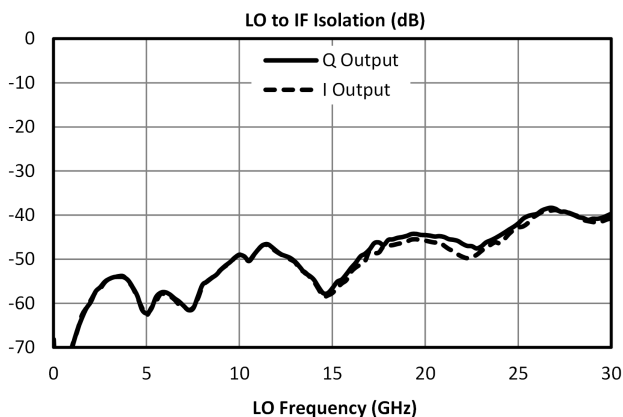
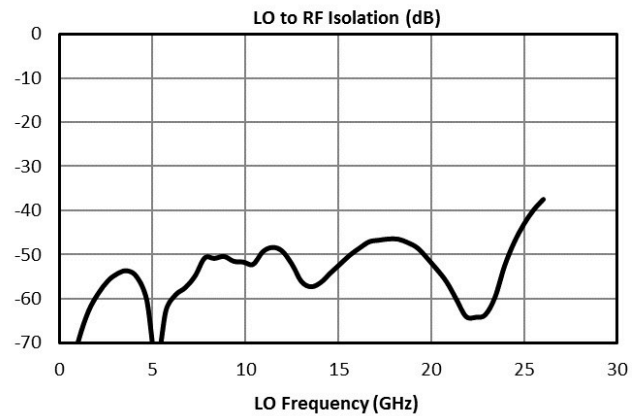
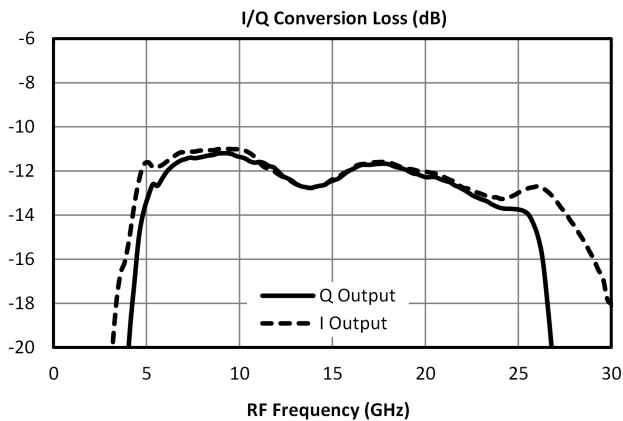

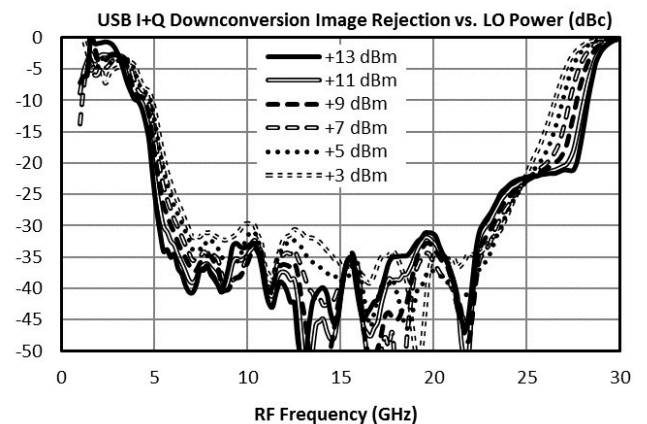
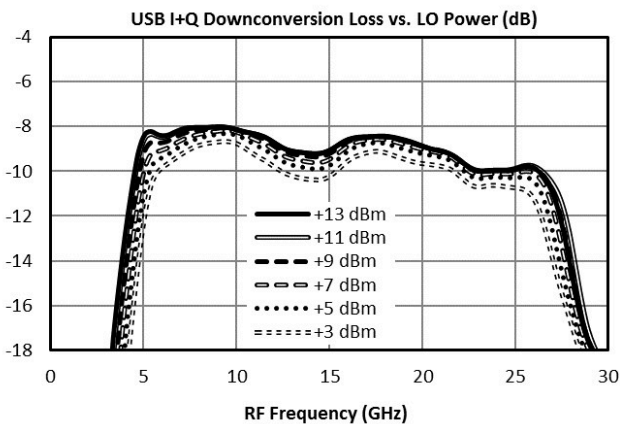
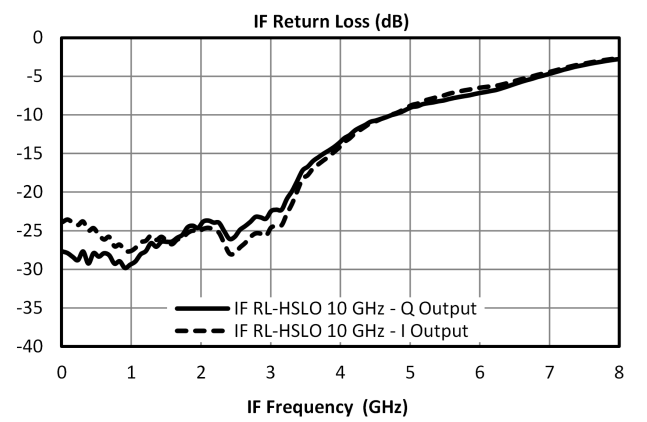
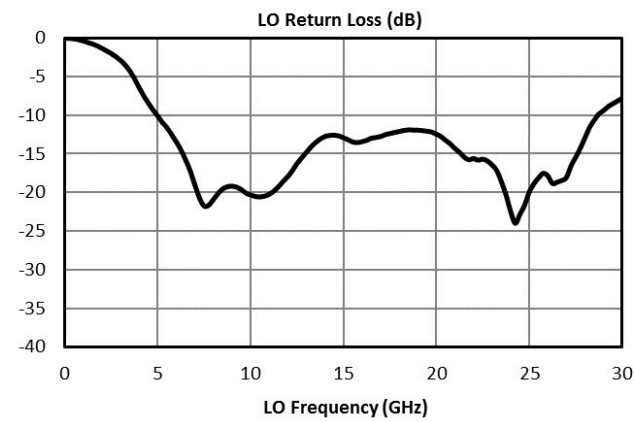
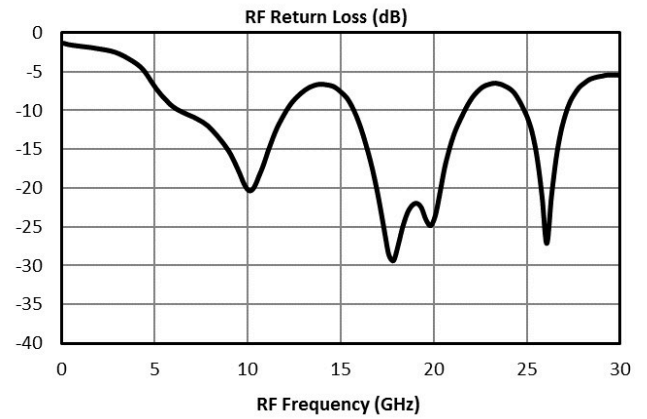
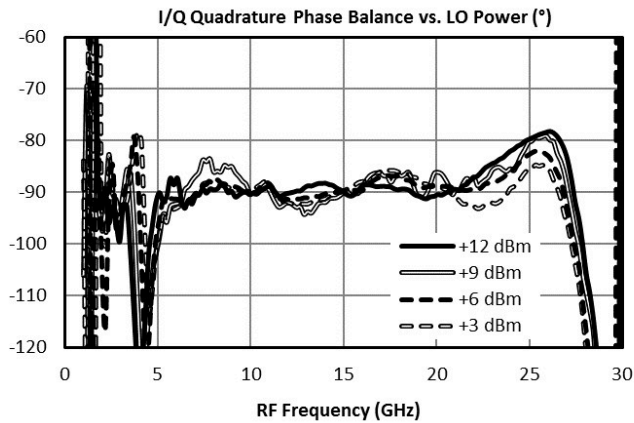
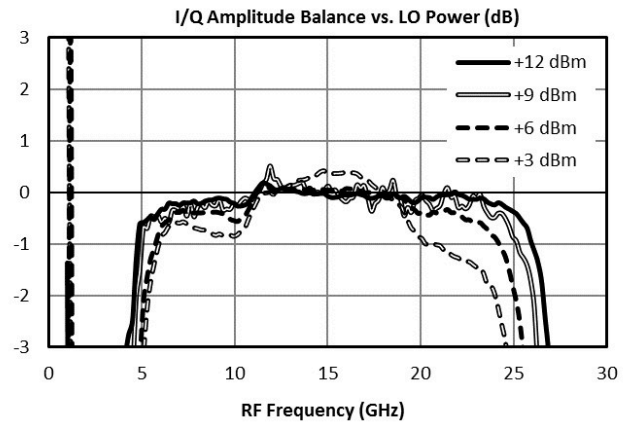
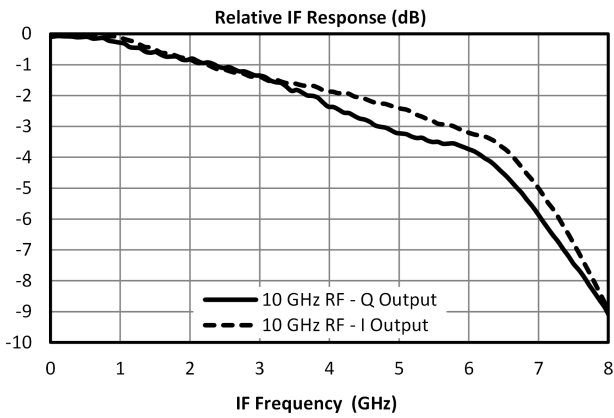

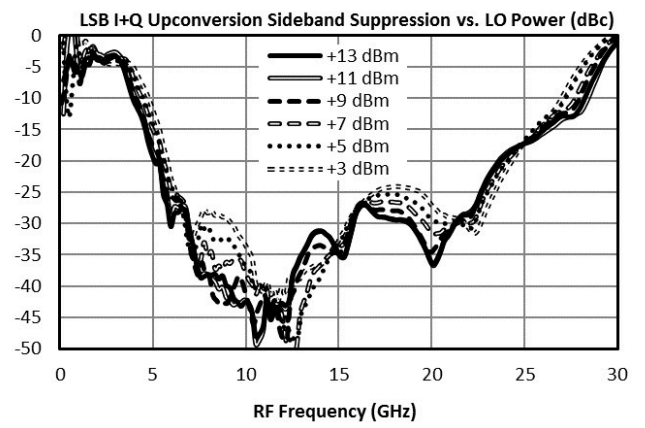
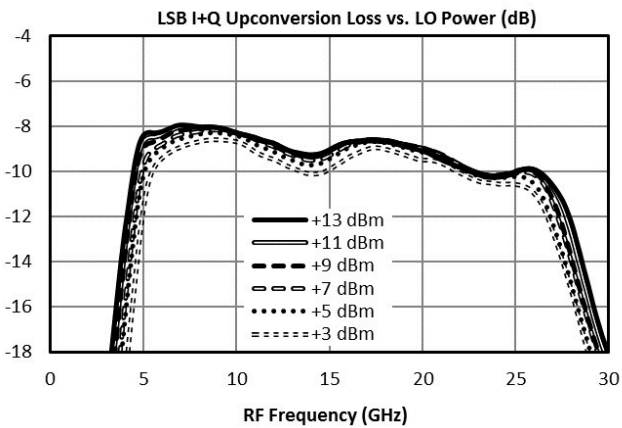
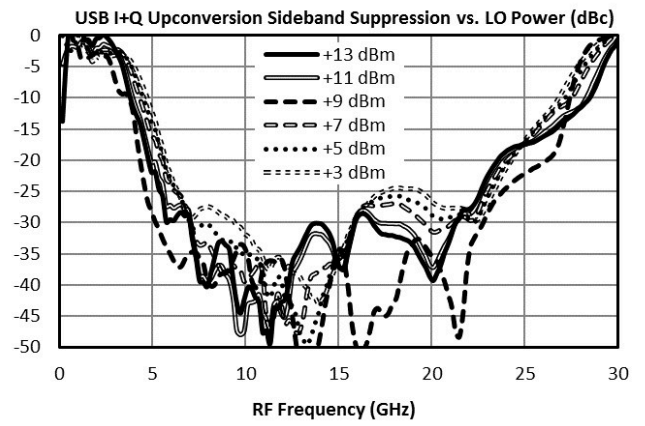
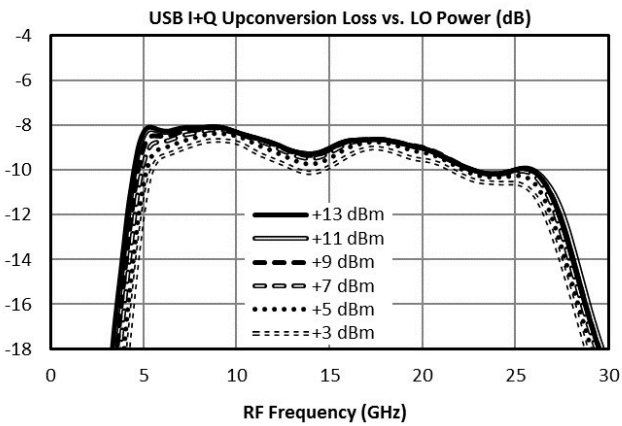
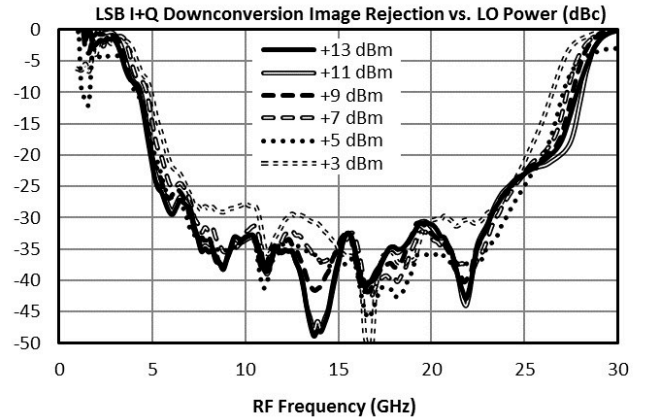
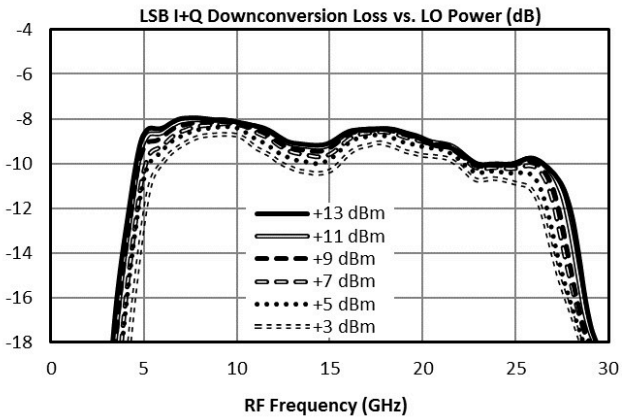

### MMIQ-0626LS - Typical Performance Plots: IP3

Performance plots for the connectorized module are shown for measurements where directly probed measurements of the die are unavailable. Note that the following measurements include losses from connectors and microstrip traces.

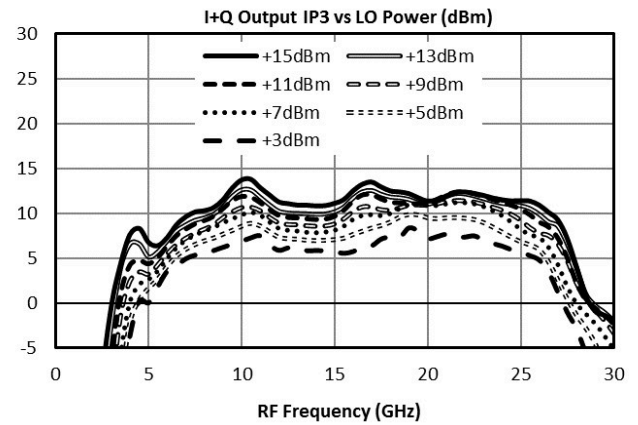
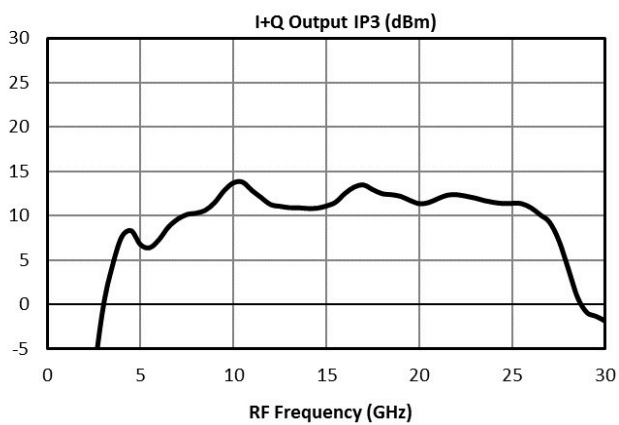
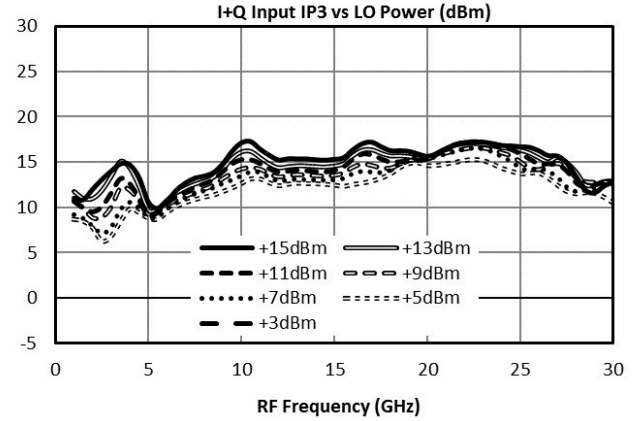
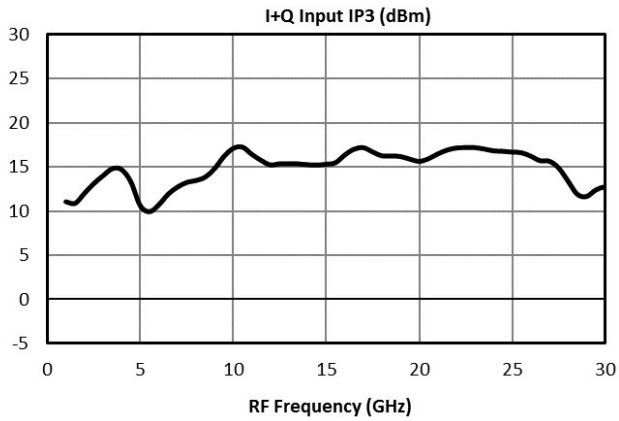

**MMIQ-0626LS - Typical Performance Plots: P1dB**

Input 1dB compression point (P1dB) plots are taken with the following test conditions and frequency plan:

Parameter		Port	Start	Nominal	Stop	Units
RF Input Frequency		1		10		GHz
RF Input Power			-4		+10	dBm
LO Input Frequency		2		10.091		GHz
LO Input Power			+3	+9	+17	dBm
IF Output Frequency	Q	3		91		MHz
	I	4		91		
$T_A$ , Ambient Temperature				+25		°C
$Z_0$ , System Impedance				50		$\Omega$

Performance plots for the connectorized module are shown for measurements where directly probed measurements of the die are unavailable. Note that the following measurements include losses from connectors and microstrip traces.

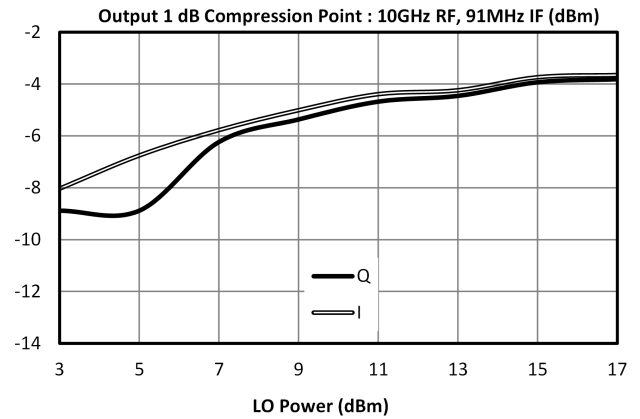
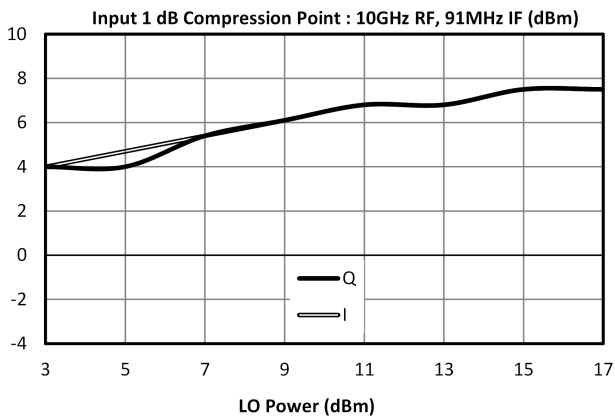

**MMIQ-0626LS - Typical Performance Plots: LO Harmonic Isolation**

LO Harmonic Isolation plots are taken with the following test conditions and based on the following fundamental input signal frequency plan:

Parameter	Port	Start	Nominal	Stop	Units
RF Input Frequency	1	0		30	GHz
RF Input Power			-10		dBm
LO Input Frequency	2	0.091		30.091	GHz
LO Input Power				+9	
IF Output Frequency	3		91		MHz
	4		91		
$T_A$ , Ambient Temperature			+25		°C
$Z_0$ , System Impedance			50		$\Omega$

Performance plots for the connectorized module are shown for measurements where directly probed measurements of the die are unavailable. Note that the following measurements include losses from connectors and microstrip traces.

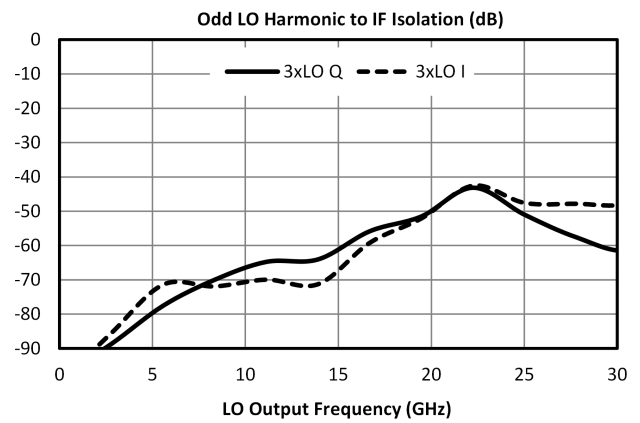
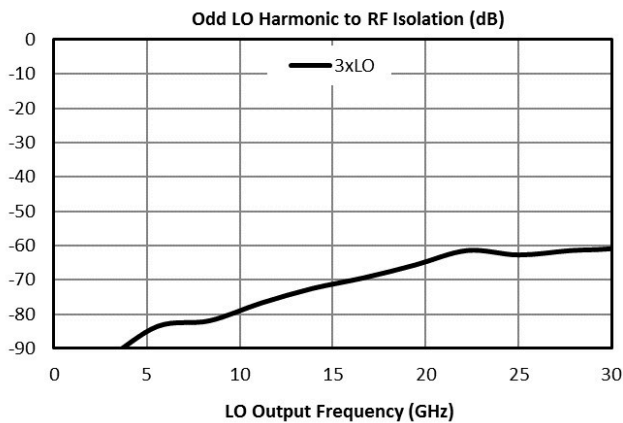
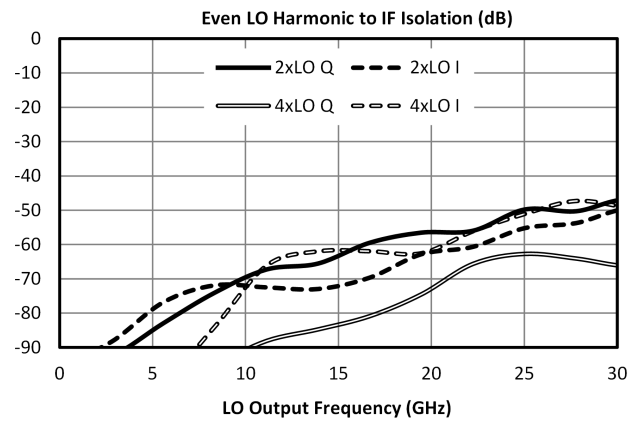
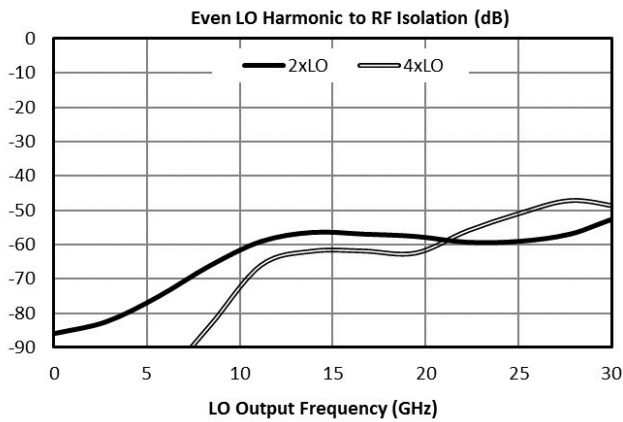

**MMIQ-0626LS - Typical Performance Plots: Band Shifter**

Band Shifter performance plots are taken with the following test conditions and frequency plan:

Parameter	Port	Start	Nominal	Stop	Units
IF Input Frequency	2		See Plot		GHz
IF Input Power	2		-10		dBm
LO Input Frequency <sup>9</sup>	3+4	0.7		15	GHz
LO Input Power	3+4		+9		dBm
RF Output Frequency	1	IF+0.7		IF+15	GHz
T <sub>A</sub> , Ambient Temperature			+25		°C
Z <sub>0</sub> , System Impedance			50		Ω

Band shifter utilizes the mixer in a unique configuration with a low frequency LO signal. Refer to the Application Information section for more details.

<sup>9</sup> Low frequency LO quadrature hybrid used to take data is the QH-0R714.

Performance plots for the connectorized module are shown for measurements where directly probed measurements of the die are unavailable. Note that the following measurements include losses from connectors and microstrip traces.

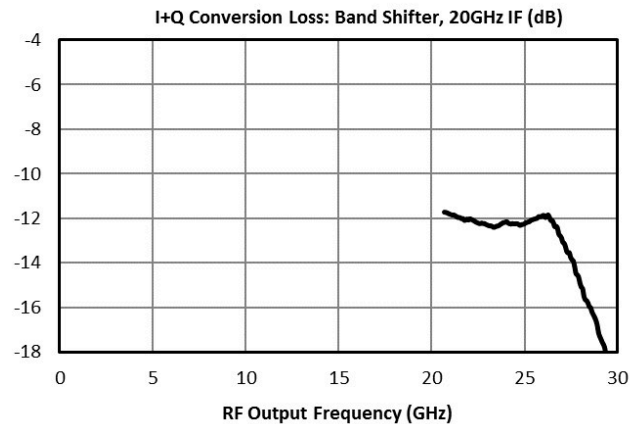
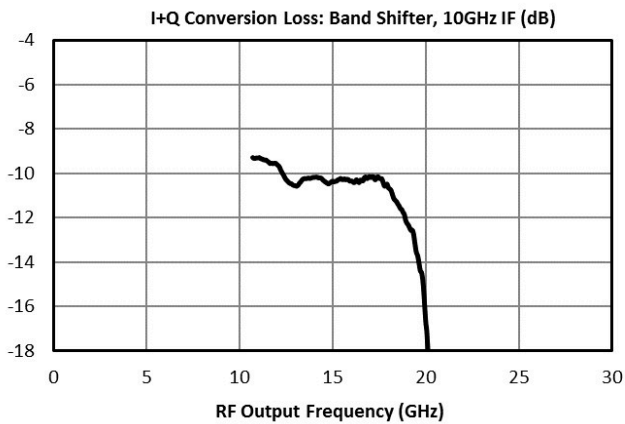

**MMIQ-0626LS - Typical Performance Plots: Vector Modulator**

Vector Modulator performance plots are taken with the following test conditions and frequency plan:

Parameter	Port	Start	Nominal	Stop	Units
Input Frequency	2	0		30	GHz
Input Power			-10		dBm
I/Q Input Current	Q	3	+19		mA
	I	4	+19		
Output Frequency	1	0		30	GHz
T <sub>A</sub> , Ambient Temperature			+25		°C
Z <sub>0</sub> , System Impedance			50		Ω

Nominal I/Q bias current given in the table to the right to tune a 10 GHz input signal's phase to 0°, 90°, 180°, or 270° at the port 1 RF output.

Phase Shift (°)	I Port 4 Input Current (mA)	Q Port 3 Input Current (mA)
0	+19	+19
90	-19	+3
180	-19	-19
270	+19	-3

Performance plots for the connectorized module are shown for measurements where directly probed measurements of the die are unavailable. Note that the following measurements include losses from connectors and microstrip traces.

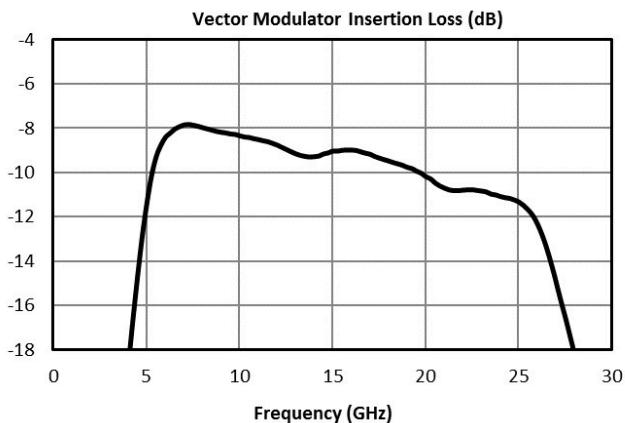

## MMIQ-0626LCH-2

### Low LO Drive Passive GaAs MMIC IQ Mixer

Vector Modulator Normalized Insertion Loss vs Phase: 10GHz (U)

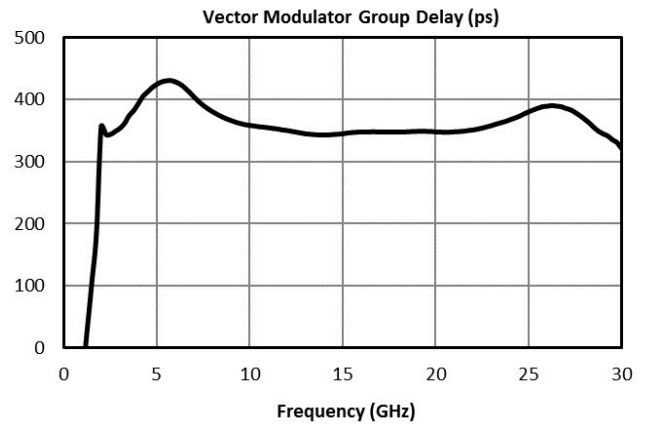
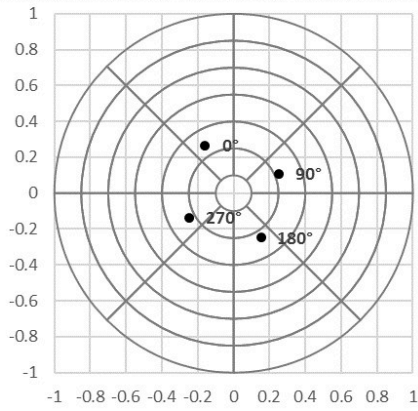

Vector Modulator Insertion Loss vs Phase: 10GHz (dB)

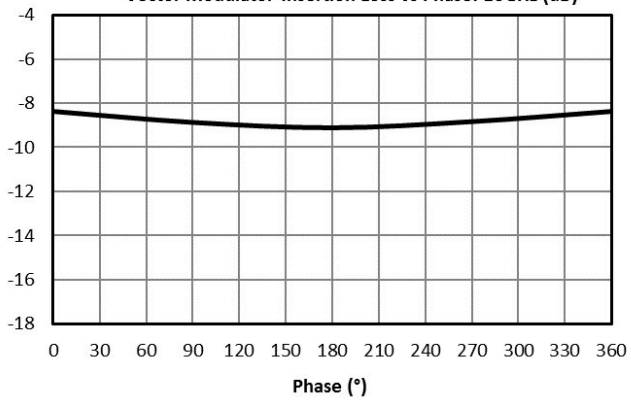

**Spur Table**

**Typical Spurious Performance: Down-Conversion**

Typical spurious data is provided by selecting RF and LO frequencies ( $\pm m \cdot LO \pm n \cdot RF$ ) within the RF/LO bands, to create a spurious output within the IF band. The mixer is swept across the full spurious band and the mean is calculated. The numbers shown in the table below are for a -10 dBm RF input. Spurious suppression is scaled for different RF power levels by (n-1), where “n” is the RF spur order. For example, the 2RF x 2LO spur is 64 dBc for a -10 dBm input, so a -20 dBm RF input creates a spur that is (2-1) x (-10 dB) lower, or 74 dBc. Data is shown for the frequency plan in Typical Performance. mLOx0RF plots can be found in Typical Performance Plots: LO Harmonic Isolation. 0LOx1RF plot is identical to the plot of LO-RF isolation.

**Typical Down-conversion spurious suppression (dBc): I Port (Q Port)**

-10 dBm RF Input	0xLO	1xLO	2xLO	3xLO	4xLO	5xLO
0xRF	-	49 (50)	60 (60)	57 (56)	74 (75)	N/A
1xRF	21 (27)	Reference	43 (33)	45 (23)	76 (72)	N/A
2xRF	52 (56)	29 (33)	64 (67)	43 (41)	73 (75)	65 (62)
3xRF	57 (74)	45 (47)	60 (64)	59 (63)	74 (76)	54 (55)
4xRF	51 (75)	53 (62)	52 (58)	65 (72)	76 (78)	74 (78)
5xRF	N/A	N/A	78 (79)	79 (79)	70 (76)	77 (79)

## MMIQ-0626LCH-2

### Low LO Drive Passive GaAs MMIC IQ Mixer

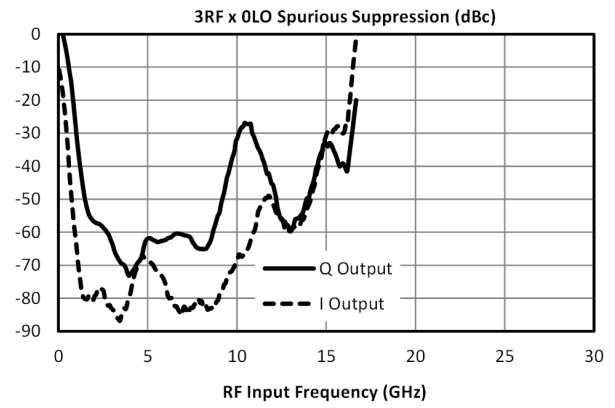
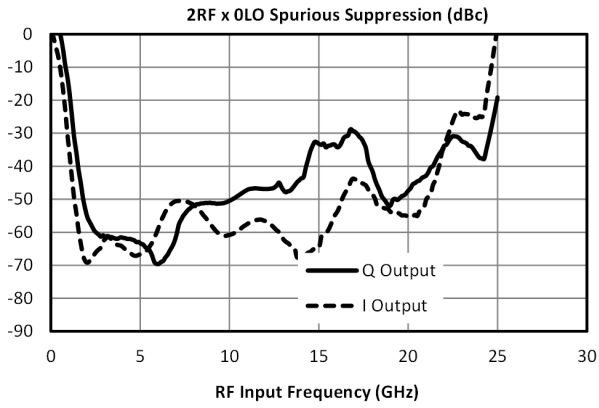

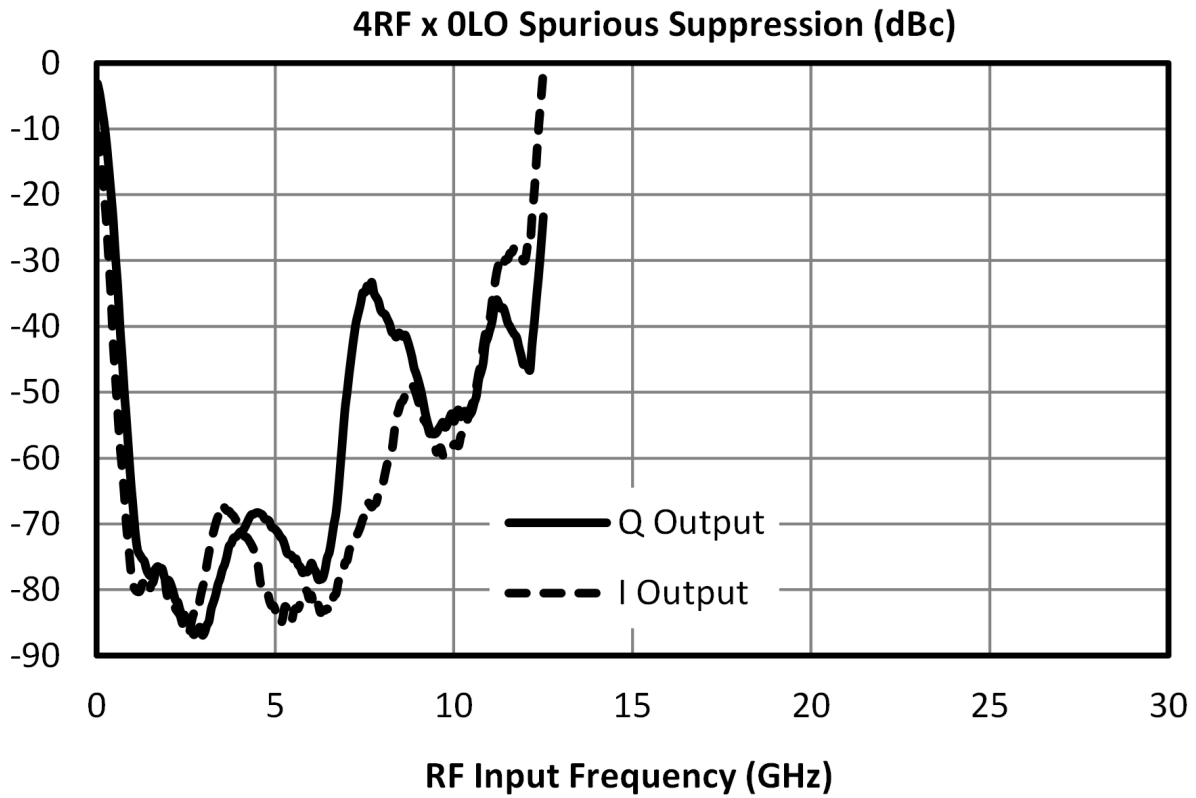

## MMIQ-0626LCH-2

### Low LO Drive Passive GaAs MMIC IQ Mixer

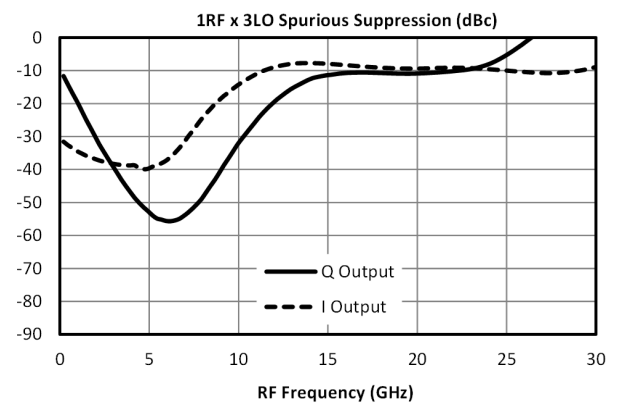
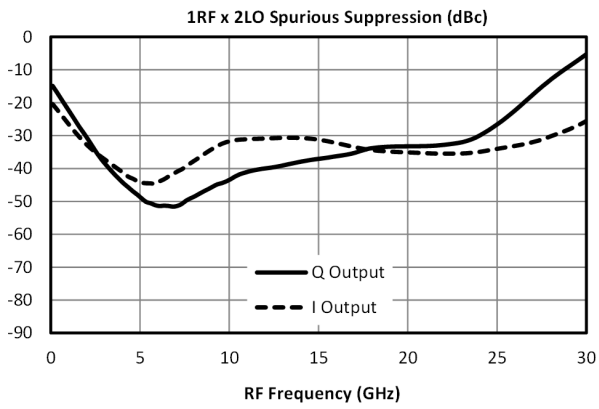

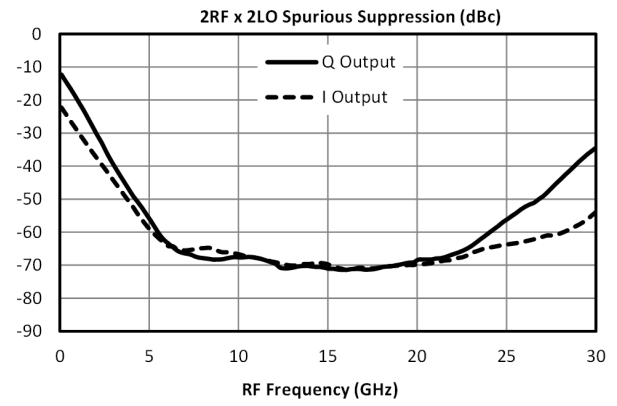
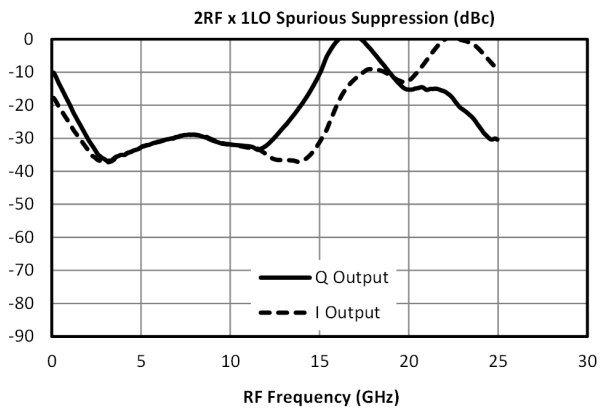

## MMIQ-0626LCH-2

### Low LO Drive Passive GaAs MMIC IQ Mixer

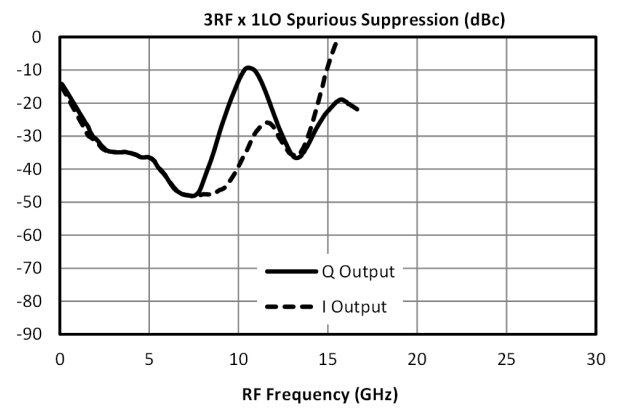
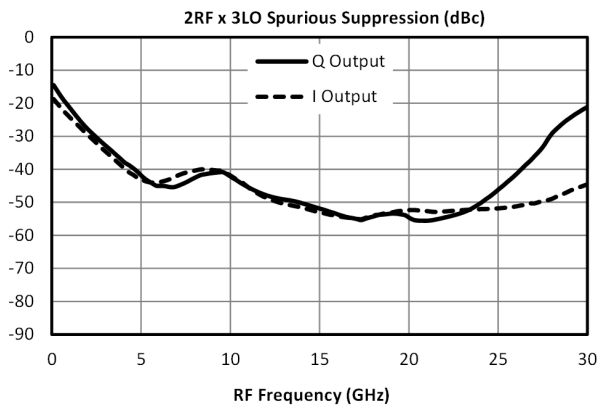

## MMIQ-0626LCH-2

### Low LO Drive Passive GaAs MMIC IQ Mixer

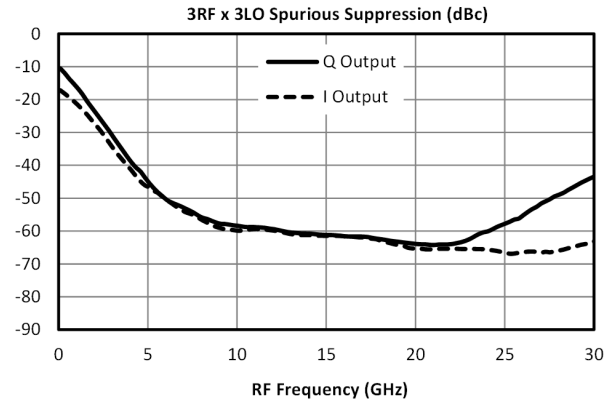
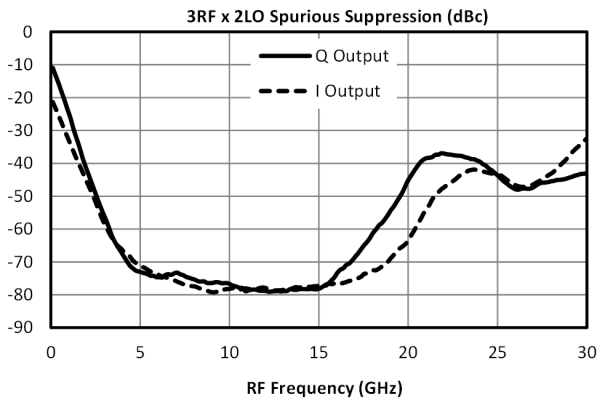

**Typical Spurious Performance: Up-Conversion**

Typical spurious data is taken by mixing an input within the IF band, with LO frequencies ( $\pm m \cdot LO \pm n \cdot IF$ ), to create a spurious output within the RF output band. The mixer is swept across the full spurious output band and the mean is calculated. The numbers shown in the table below are for a -10 dBm IF input. Spurious suppression is scaled for different IF input power levels by (n-1), where “n” is the IF spur order. For example, the 2IFx1LO spur is typically 60 dBc for a -10 dBm input with a sine-wave LO, so a -20 dBm IF input creates a spur that is (2-1) x (-10 dB) lower, or 70 dBc. Data is shown for the frequency plan in Typical Performance.

**Typical Up-conversion spurious suppression (dBc): I Port (Q Port)**

-10 dBm RF Input	0xLO	1xLO	2xLO	3xLO	4xLO	5xLO
0xIF	-	39 (44)	59 (59)	67 (67)	66 (66)	N/A
1xIF	29 (29)	Reference	42 (39)	21 (14)	81 (72)	N/A
2xIF	69 (69)	60 (62)	52 (56)	75 (70)	80 (82)	81 (84)
3xIF	81 (84)	51 (55)	60 (67)	53 (36)	84 (78)	61 (63)
4xIF	90 (93)	91 (95)	75 (81)	97 (92)	102 (95)	99 (101)
5xIF	107 (110)	79 (85)	89 (96)	78 (62)	110 (102)	107 (105)

## MMIQ-0626LCH-2

### Low LO Drive Passive GaAs MMIC IQ Mixer

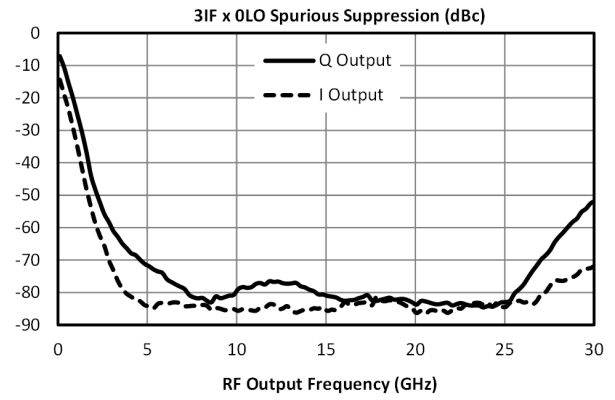
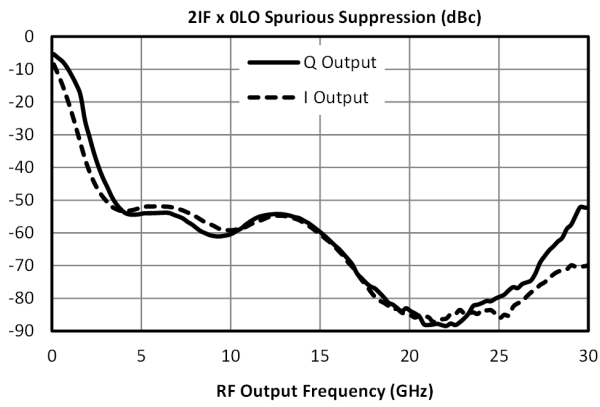

## MMIQ-0626LCH-2

### Low LO Drive Passive GaAs MMIC IQ Mixer

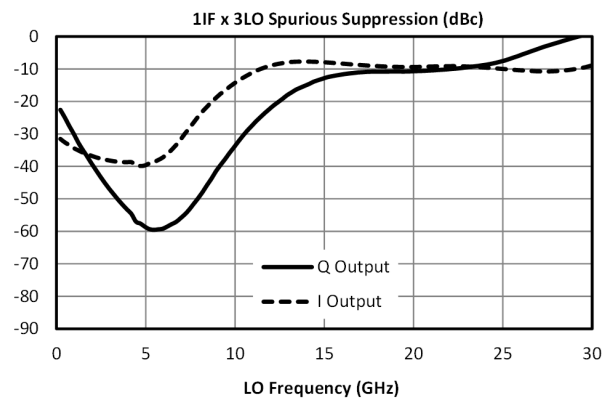
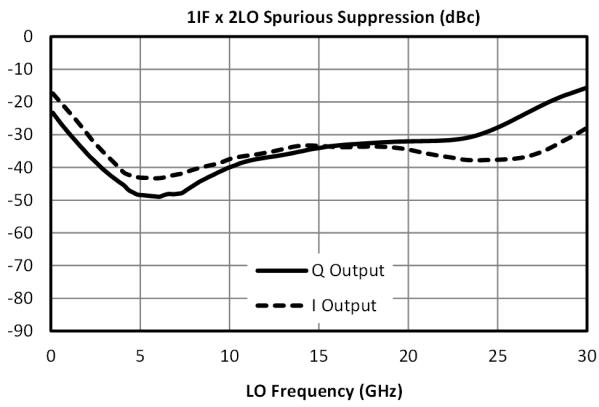

## MMIQ-0626LCH-2

### Low LO Drive Passive GaAs MMIC IQ Mixer

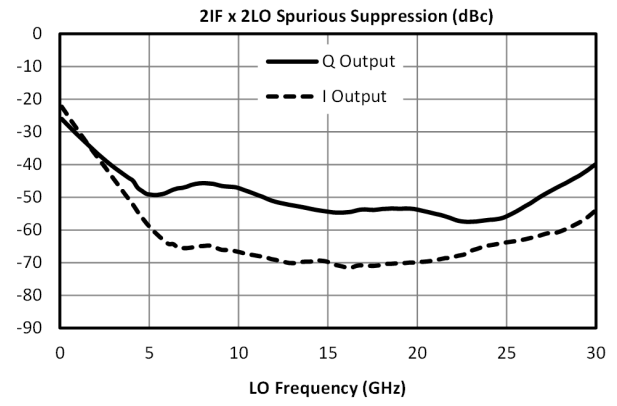
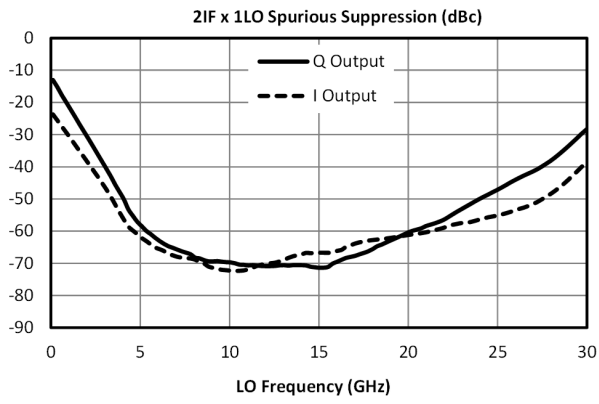

## MMIQ-0626LCH-2

### Low LO Drive Passive GaAs MMIC IQ Mixer

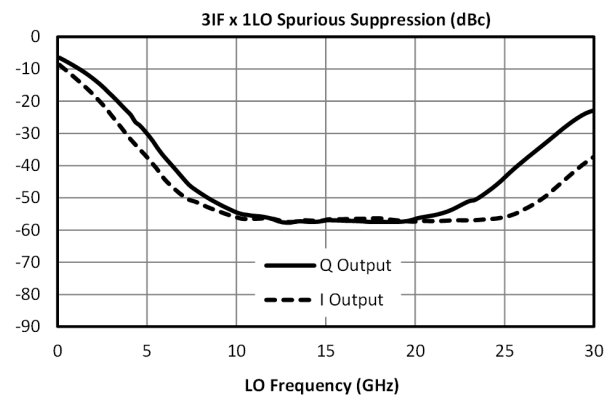
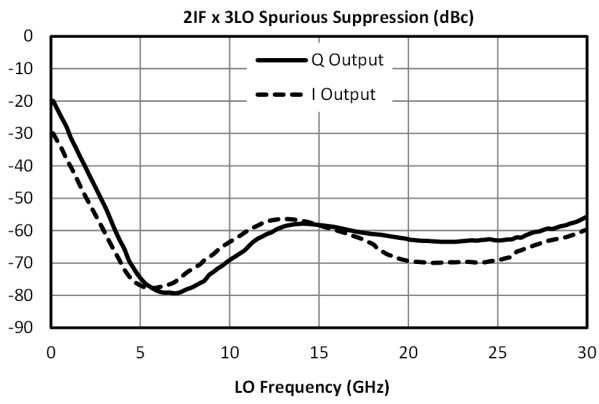

## MMIQ-0626LCH-2

### Low LO Drive Passive GaAs MMIC IQ Mixer

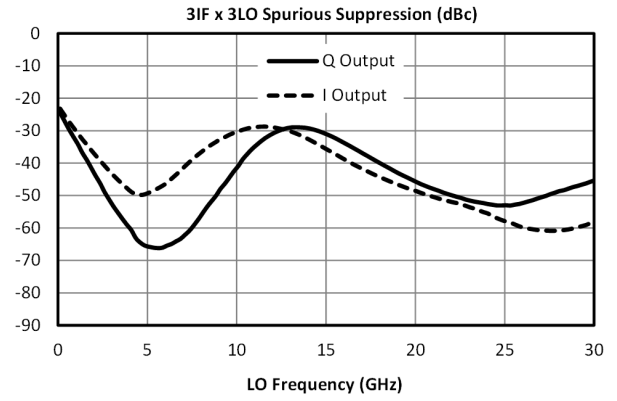
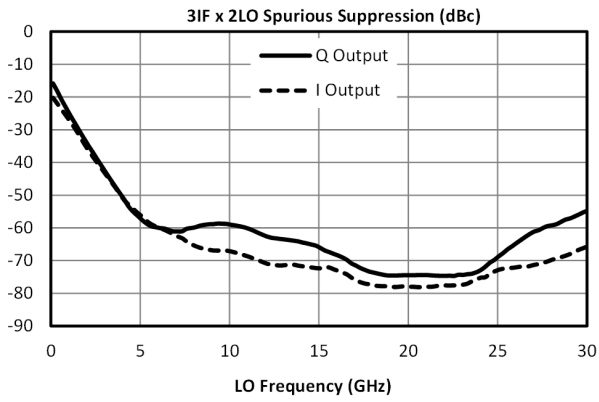

**Application Circuit**

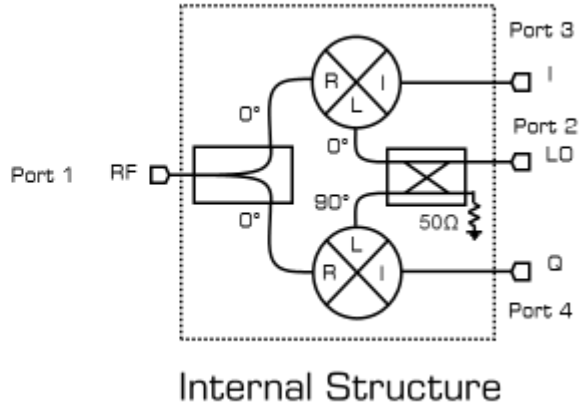
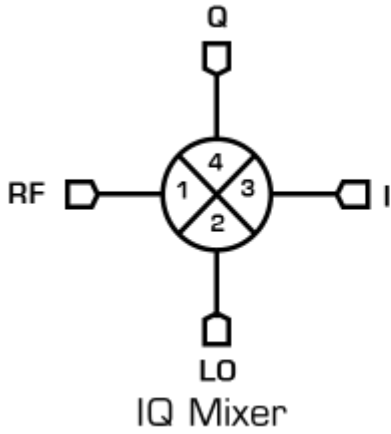

## Application Circuit Description

### Detailed Description

MMIQ-0626 belongs to Marki Microwave's MMIQ family of mixers. The MMIQ product line consists of passive GaAs MMIC mixers designed and fabricated with GaAs Schottky diodes. MMIQ mixers offer excellent amplitude and phase balance from the due to its on-chip LO quadrature hybrid. Up to 40dB of image rejection (i.e., single sideband suppression) can be obtained by using the MMIQ-0626 as an image rejection or single sideband mixer. The MMIQ-0626H is the sister mixer of the MMIQ-0626L. The MMIQ-0626H requires a higher LO drive to operate the mixer. In exchange, the MMIQ-0626H displays higher linearity (i.e., higher IIP3, P1dB, Spurious Suppression) than the MMIQ-0626L. Marki H and L diodes correspond to different diode forward turn on voltages.

Support for the X, Ku, and K bands are offered by the ultra-broadband performance of the mixer's RF and LO ports (ports 1 and 2). Direct baseband to K band frequency conversions are available by using this mixer as an up-converter. Traditional use of this mixer to do image reject or single sideband mixing is available with an external IF quadrature hybrid. The MMIQ-0626 is also suitable for use as a Vector Modulator through DC bias of the I and Q ports (ports 3 and 4).

Port 1, the RF port, and port 2, the LO port, supports a 6-26GHz signal. Ports 3 and 4, the I and Q ports, support a DC-6GHz signal. A signal may be input into any port of the mixer which supports that signal's frequency. This is the basis of using the mixer as a band shifter.

For a given LO power within the recommended operating range, the RF (in the case of a down conversion) or IF (in the case of an up conversion) input power should be below the input 1dB compression point to avoid signal distortion. The input 1dB compression point will vary across the mixer's operating bandwidth and with LO input power. Careful characterization is required for optimal performance for each application. There is no minimum small signal input power required for operation. Excessive RF/IF input power increases non-desired spurious output power and degrades the fundamental conversion loss. Excessive LO input power can also cause this effect. The table below describes how to use an IQ mixer and quad hybrid to select a single sideband.

Up Conversion		
Hybrid Port	Mixer Port	Sideband Selected
0	I	Lower Sideband
90	Q	
90	I	Upper Sideband
0	Q	
Down Conversion		
Hybrid Port	Mixer Port	Sideband Selected
0	I	Upper Sideband
90	Q	
90	I	Lower Sideband
0	Q	

**Down-Converter**

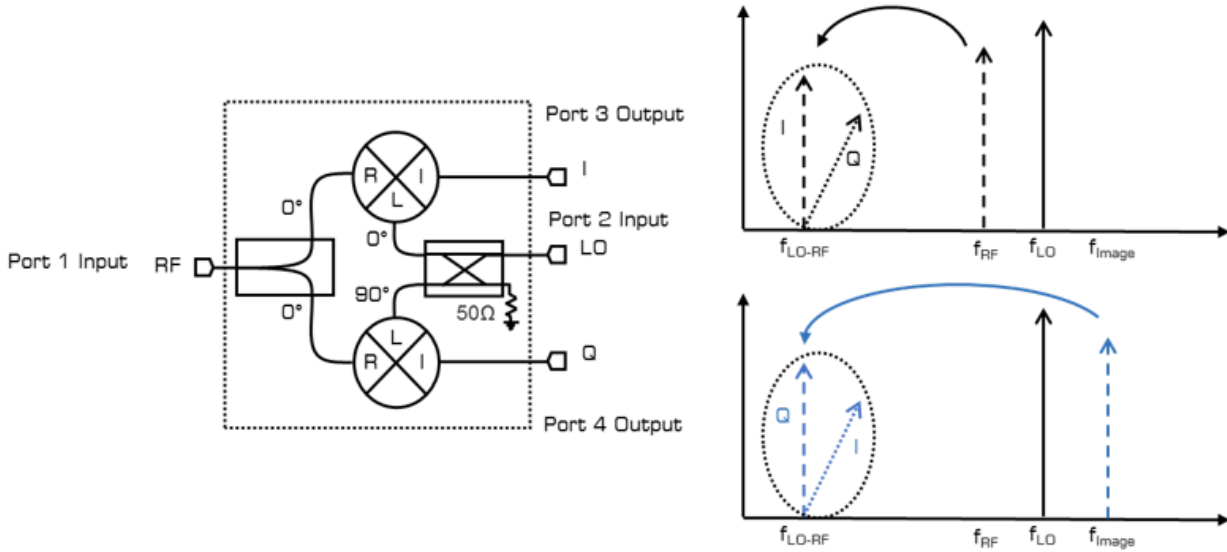

A down converter is a mixer application which takes a high frequency small signal RF input, and a high frequency large signal LO input and mixes the signals together to produce a low frequency IF output. The fundamental  $1RF \times 1LO$  outputs present at the IF port are the  $f_{LO-RF}$  and  $f_{LO+RF}$  tones. The desired output in a down conversion is typically the  $f_{LO-RF}$  term. An image frequency at  $f_{Image} = f_{2LO-RF}$  will also down convert to the  $f_{LO-RF}$  frequency. The above illustration shows the relative location of the image frequency for a highside LO, or the frequency plan for which  $f_{LO} > f_{RF}$ .

To use the IQ mixer as a down converter, input a high frequency small signal RF input into port 1, a high frequency large signal LO input into port 2, and pull the low frequency IF output from ports 3 and 4. Ports 3 and 4 will output the IF signals I and Q. I and Q IF outputs will be at the same frequency but 90° out of phase (i.e., I and Q are in quadrature). If only a single IF output is desired, terminate either the I or Q ports with a wideband 50Ω load.

This is the input scheme was used to take I/Q down-conversion data found in the Typical Performance Plots section.

**Image Reject Down-Converter**

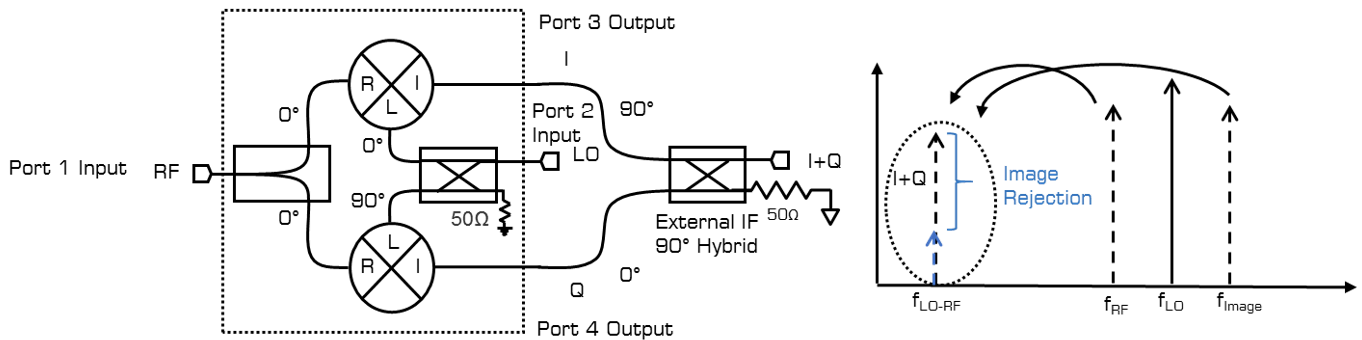

An image reject mixer is a mixer which rejects the down converted image frequency from the IF output. Image reject mixers are constructed using an external quadrature hybrid attached to the I and Q (i.e., IF) output ports. Using the external IF quadrature hybrid, one can select the whether the upper sideband or lower sideband signal is suppressed with respect to the LO signal.

To use the IQ mixer as an image reject mixer, input the high frequency small signal RF into port 1 and a high frequency large signal LO input into port 2. Take the combined I+Q down converted signal through the IF quadrature hybrid. Select the upper sideband (i.e., suppress the lower sideband) by connecting the I port to the 0° port of the IF quadrature hybrid and attach the Q port to the 90° port of the IF quadrature hybrid. Select the lower sideband (i.e., suppress the upper sideband) by attaching the I port to the 90° port of the IF quadrature hybrid and attach the Q port to the 0° port of the IF quadrature hybrid.

This is the input scheme was used to take image rejection down-conversion data found in the Typical Performance Plots section.

**Up-Converter**

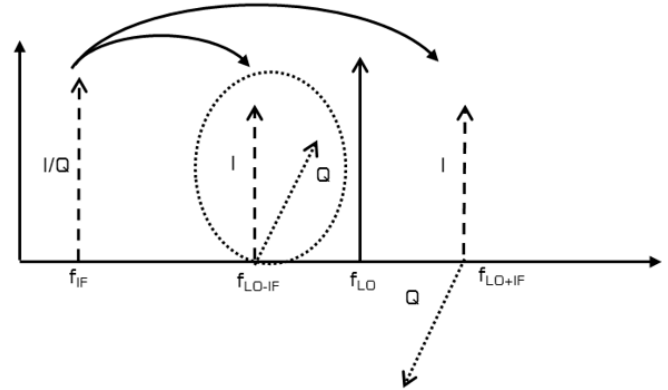
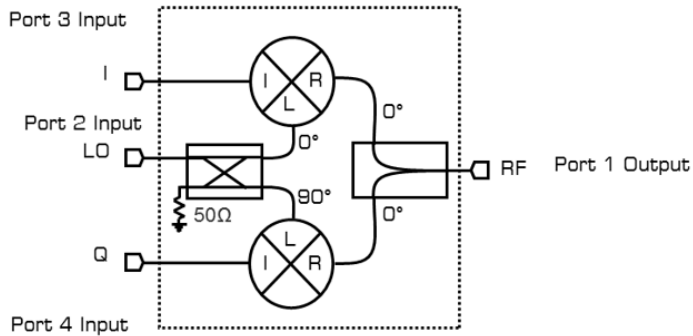

An up converter is a mixer application which takes a low frequency small signal IF input, and a high frequency large signal LO input and mixes the signal together to produce a high frequency RF output. The fundamental  $1f_{IF} \times 1f_{LO}$  outputs present at the RF port are the  $f_{LO-IF}$  and  $f_{LO+RF}$  tones. An up conversion can select either the  $f_{LO-IF}$  or the  $f_{LO+IF}$  tones. The above illustration shows both up converted sidebands with either an I or Q port input signal.

To use the IQ mixer as an up converter, input a low frequency small signal IF input into port 3 or 4, a high frequency large signal LO input into port 2, and pull the high frequency RF output from port 1. Input into the Q port will result in a up converted signal that is 90° out of phase with the up converted I port input signal. If only a single IF input is desired, terminate either the I or Q ports with a wideband 50Ω load.

This is the input scheme used to take I/Q up-conversion data found in Typical Performance.

**Single Sideband Up-Converter**

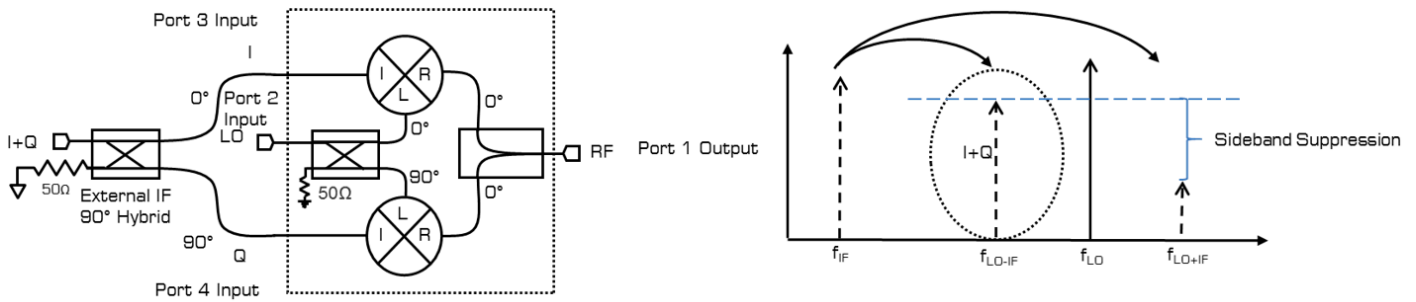

A single sideband mixer is a mixer which suppresses the up converted image frequency from the RF output. Single sideband mixers are constructed using an external quadrature hybrid attached to the I and Q (i.e., IF) input ports. Using an external IF quadrature hybrid, one can select whether the upper sideband of the lower sideband signal is suppressed with respect to the LO signal.

To use the IQ mixer as a single sideband mixer, input the low frequency small signal I+Q IF signal into the IF quadrature hybrid. The IF quadrature hybrid is attached to the I and Q ports of the IQ mixer. Input the high frequency large signal LO input into port 2 and take the up converted high frequency RF signal from port 1. Select the upper sideband (i.e., suppress the lower sideband) by attaching the I port to the 90° port of the IF quadrature hybrid and attach the Q port to the 0° port of the IF quadrature hybrid. Select the lower sideband (i.e., suppress the upper sideband) by attaching the I port to the 0° port of the IF quadrature hybrid and attach the Q port to the 90° port of the IF quadrature hybrid.

This is the input scheme used to take single sideband up-conversion data found in Typical Performance.

**Band Shifter**

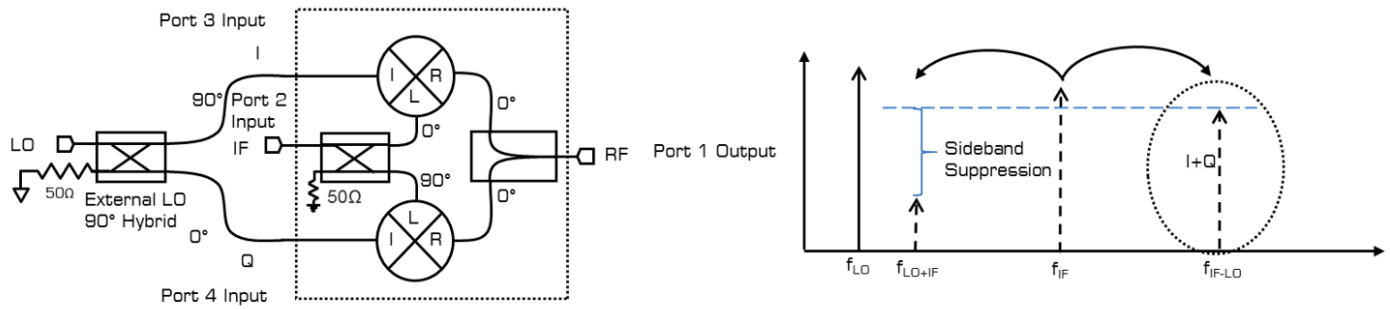

A band shifter is an unusual application for a mixer. Band shifters take an IF signal and shift it to a different band, generally to either avoid interference or for rebroadcast at a different frequency. For cases in which the desired band shift cannot be employed by using a standard up or down conversion scheme, an exotic input scheme is required.

A passive diode mixer is reciprocal on all ports. Port 1, the RF port, supports a 6-26GHz signal. Port 2, the LO port, supports a 6-26GHz signal. Ports 3 and 4, the IF ports, support a DC-6GHz signal. 2 signals input into any combination of the 3 ports, RF, LO, or IF, will result in an output signal at the 3<sup>rd</sup> port. In addition, an output signal will be present at both input ports. By using the IF port, as a large signal input port, low frequency LO applications can be supported.

The diagram above shows an IQ mixer being used as a band shifter. Using an IQ mixer as a band shifter allows for sideband suppression. This is identical to using the IQ mixer as a single sideband up converter. However, the large signal input port is now 3+4 versus port 2. Selection of the output tone is done through the orientation of the LO quadrature hybrid.

To use the mixer as a single sideband band shifter, input a low frequency large signal LO into the external LO quadrature hybrid. Input the high frequency small signal IF signal into port 2 and take the high frequency RF output from port 1. Select the upper sideband (i.e., suppress the lower sideband) by attaching the I port to the 90° port of the IF quadrature hybrid and attach the Q port to the 0° port of the LO quadrature hybrid. Select the lower sideband (i.e., suppress the upper sideband) by attaching the I port to the 0° port of the LO quadrature hybrid and attach the Q port to the 90° port of the LO quadrature hybrid.

This is the input scheme used to take band shifter data found in the Typical Performance Plots: Band Shifter section.

Using this input scheme requires careful accounting of which input signal is injecting which port. Injecting a signal into any port which does not support the correct band will lead to a degraded or no output response. Abide by the maximum DC current input into the I and Q ports of the mixer or otherwise irreversible damage to the mixer will occur.

The limiting factor in use of the mixer as an image reject band shifter is in the bandwidth of the external LO quadrature hybrid and bandwidth of the I and Q ports.

**Vector Modulator**

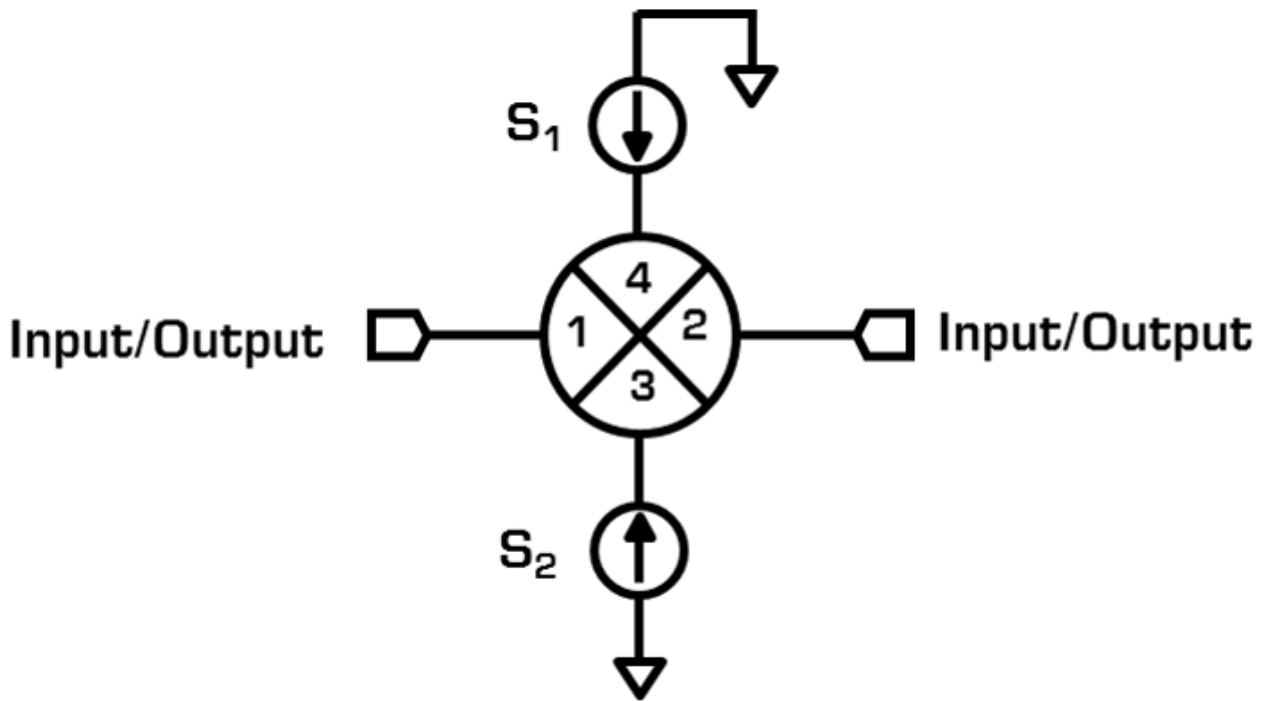

A vector modulator is a device that can modulate an input signal’s amplitude and phase. Similar to using a double balanced mixer as a phase modulator or phase shifter, an IQ mixer can be used as a vector modulator. An IQ mixer can be used as a vector modulator by inputting DC current into both the I and Q ports.

Injecting DC current into both the I and Q ports forward biases both mixer cores and causes them to be shorted. This connects the RF and LO baluns allowing the input signal to pass from balun to balun without a frequency conversion. Modulating the DC current into either or both I and Q mixers causes both the phase and amplitude to modulate based on the polarity of the input current and the magnitude of the input current. Modulating only the I or Q mixers causes the device to behave as a biphaser modulator (i.e., the device can only swing the phase from +90° to -90°).

To use the IQ mixer as a vector modulator, supply a DC current sufficient to turn on the mixer through both the I and Q ports. An example bias condition is given in Typical Performance Plots: Vector Modulator for the MMIQ-0626L with the phase set to 0°, 90°, 180°, and 270° for a 10GHz input. Current limiting the DC source to the maximum DC current value found in Absolute Maximum Ratings is recommended to prevent irreversible damage to the vector modulator. The typical DC current required to turn on the vector modulator is <30mA.

This is the measurement scheme used to take vector modulator data found in the Typical Performance Plots: Vector Modulator section.

It is recommended to sequence the vector modulator by slowly increasing the DC bias until the vector modulator is operating at the user desired condition.

Near the band edges of the vector modulator, more current than is typical for mid-band operation may be necessary to achieve the same amplitude and phase shift. This is due to the on chip LO quadrature hybrid operating near it’s band edge.

## Die Mounting Recommendations

### Mounting and Bonding Recommendations

Marki MMICs should be attached directly to a ground plane with conductive epoxy. The ground plane electrical impedance should be as low as practically possible. This will prevent resonances and permit the best possible electrical performance. Datasheet performance is only guaranteed in an environment with a low electrical impedance ground.

#### Mounting

To epoxy the chip, apply a minimum amount of conductive epoxy to the mounting surface so that a thin epoxy fillet is observed around the perimeter of the chip. Cure epoxy according to manufacturer instructions.

#### Wire Bonding

Ball or wedge bond with 0.025 mm (1 mil) diameter pure gold wire. Thermosonic wirebonding with a nominal stage temperature of 150 °C and a ball bonding force of 40 to 50 grams or wedge bonding force of 18 to 22 grams is recommended. Use the minimum level of ultrasonic energy to achieve reliable wirebonds. Wirebonds should be started on the chip and terminated on the package or substrate. All bonds should be as short as possible <0.31 mm (12 mils).

#### Circuit Considerations

50  $\Omega$  transmission lines should be used for all high frequency connections in and out of the chip. Wirebonds should be kept as short as possible, with multiple wirebonds recommended for higher frequency connections to reduce parasitic inductance. In circumstances where the chip more than .001" thinner than the substrate, a heat spreading spacer tab is optional to further reduce bondwire length and parasitic inductance.

## Handling Precautions

### General Handling

Chips should be handled with care using tweezers or a vacuum collet. Users should take precautions to protect chips from direct human contact that can deposit contaminants, like perspiration and skin oils on any of the chip's surfaces.

### Static Sensitivity

GaAs MMIC devices are sensitive to ESD and should be handled, assembled, tested, and transported only in static protected environments.

### Cleaning and Storage

Do not attempt to clean the chip with a liquid cleaning system or expose the bare chips to liquid. Once the ESD sensitive bags the chips are stored in are opened, chips should be stored in a dry nitrogen atmosphere.

**Bonding Diagram**

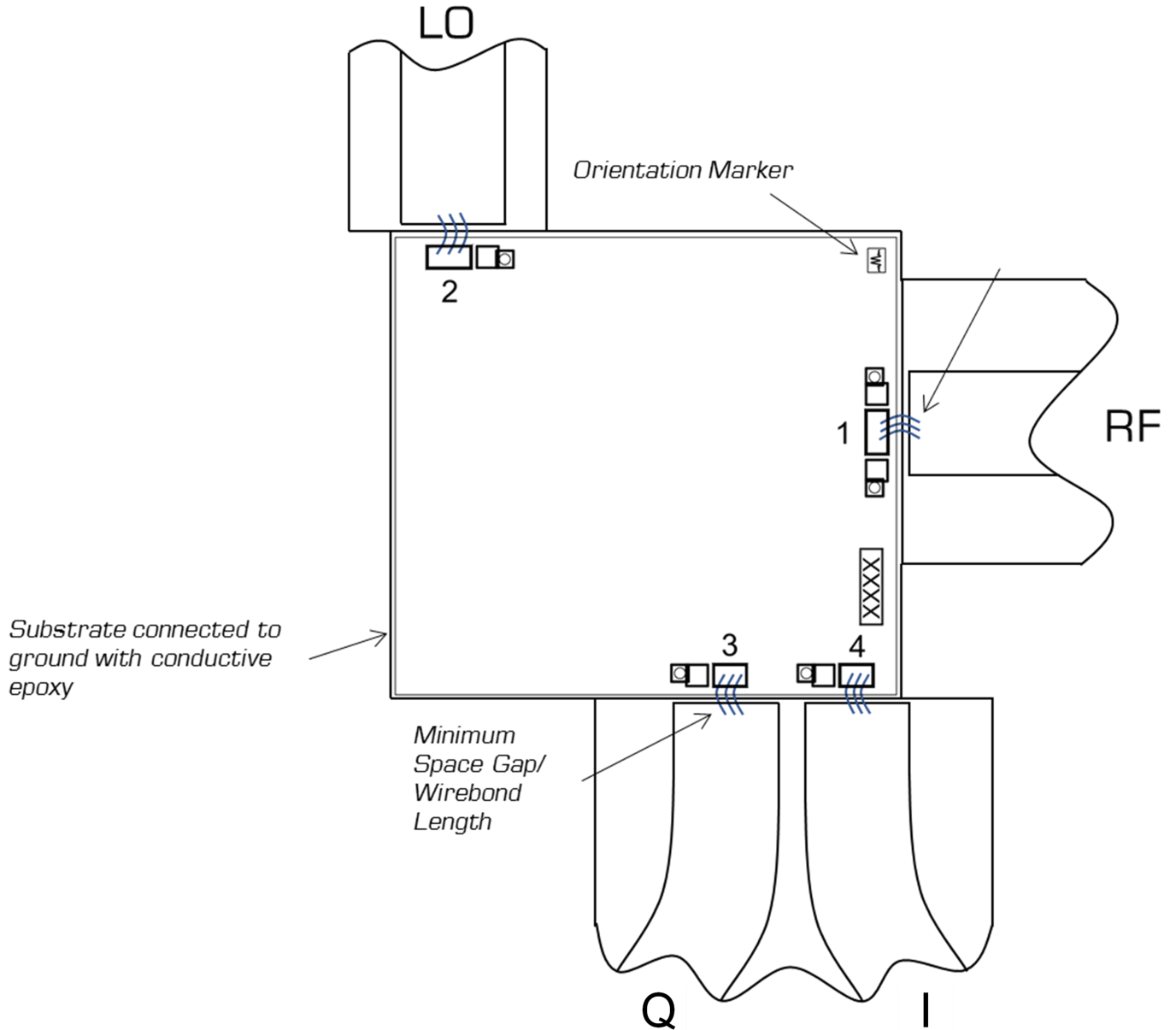

### Mechanical Data

### Outline Drawing

Download : [Outline 2D Drawing](#)

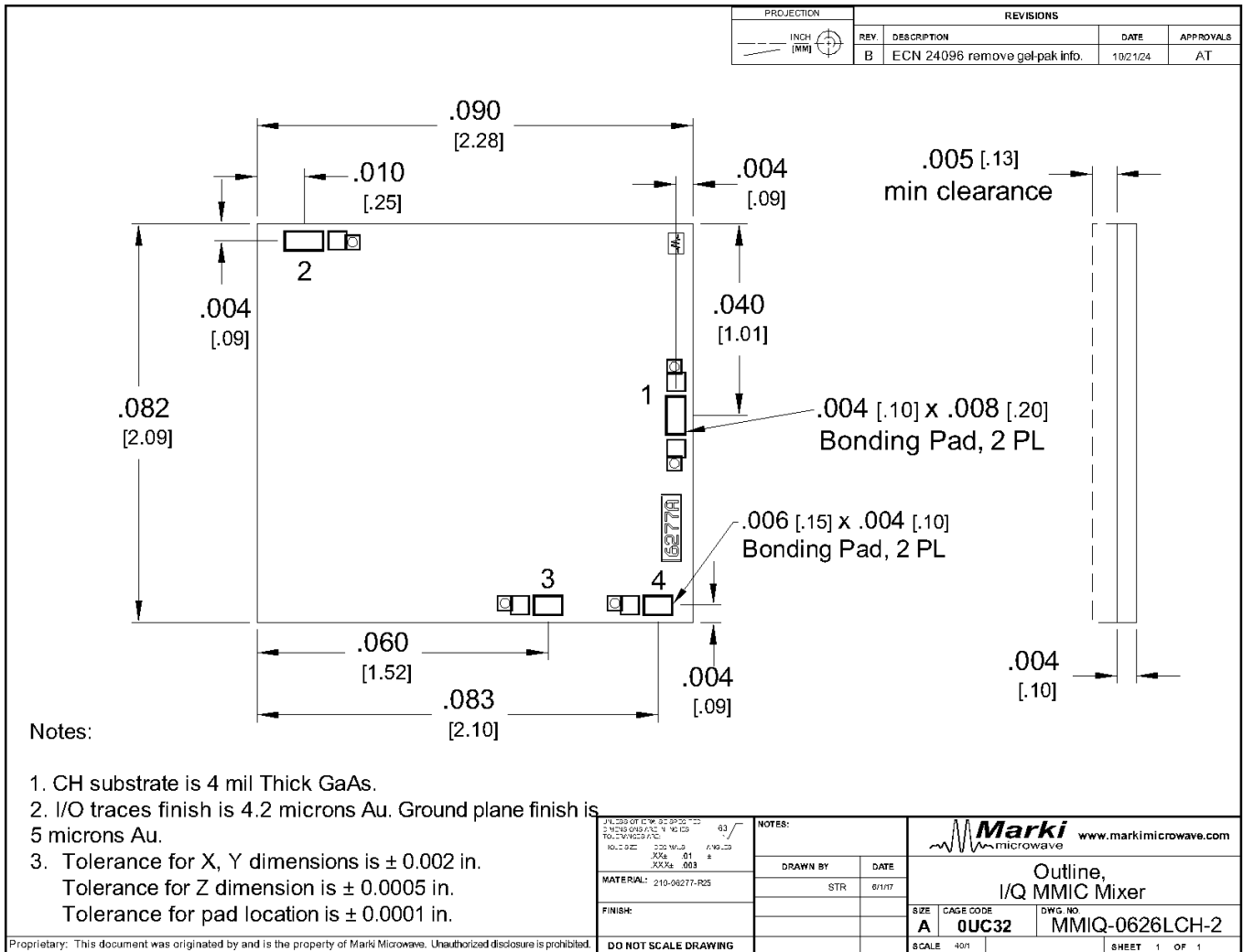

**DISCLAIMER**

MARKI MICROWAVE, INC., ("MARKI") PROVIDES TECHNICAL SPECIFICATIONS AND DATA (INCLUDING DATASHEETS), APPLICATION OR OTHER DESIGN ADVICE, WEB TOOLS, AND OTHER INFORMATION AND RESOURCES "AS IS" AND WITH ALL FAULTS. MARKI DISCLAIMS ALL WARRANTIES, EXPRESS OR IMPLIED, INCLUDING, WITHOUT LIMITATION, ANY IMPLIED WARRANTIES OF MERCHANTABILITY, FITNESS FOR A PARTICULAR PURPOSE, OR NON-INFRINGEMENT. These resources are intended for developers skilled in the art designing with Marki products. You are solely responsible for (1) selecting the appropriate products for your application, (2) designing, validating, and testing your application, and (3) ensuring your application meets applicable standards and other requirements. Marki makes no guarantee regarding the suitability of its products for any particular purpose, nor does Marki assume any liability whatsoever arising out of your use or application of any Marki product.

Marki grants you permission to use these resources only for development of an application that uses Marki products. Other reproduction or use of these resources is strictly prohibited. No license is granted to any other Marki intellectual property or to any third-party intellectual property. Marki reserves the right to make changes to the product(s) or information contained herein without notice.

MARKI MICROWAVE and T3 MIXER are trademarks or registered trademarks of Marki Microwave, Inc. All other trademarks used are the property of their respective owners.

© 2017 - 2019, 2022, Marki Microwave, Inc