

MM1-1467HCH-1

GaAs MMIC mmWave Tuner Mixer

DEVICE OVERVIEW

General Description

MM1-1467H is a GaAs MMIC double balanced mixer with a broad IF bandwidth and low conversion loss. This mixer is ideal for applications which require broad IF bandwidths with operation at mmWave frequencies. The MM1-1467H is available as both wire bondable die and as connectorized modules. The -1 option for die is available for this mixer. Both the -1 and -2 mixers are electrically identically but with mirrored footprints.

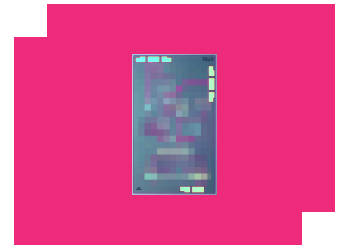

Features

- High LO to RF isolation
- Broad IF bands covering critical Ku & K band
- Flat IF response through K band
- High linearity

Applications

- Test and Measurement Equipment
- Fixed RF up converters
- Electronic warfare equipment

Functional Block Diagram

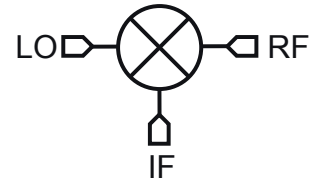

Part Ordering Options

Part Number	Description	Package	Connectors	Green Status	Product Lifecycle	Export Classification
<u>MM1-1467HUB</u>	GaAs MMIC mmWave Tuner Mixer	UB	<u>Standard</u>	REACH RoHS	Released	EAR99
MM1-1467HCH-1	GaAs MMIC mmWave Tuner Mixer	CH	-	REACH RoHS	Released	EAR99
<u>MM1-1467HCH-2</u>	GaAs MMIC mmWave Tuner Mixer	CH	-	REACH RoHS	Released	EAR99

Table Of Contents

- **Device Overview**
 - General Description
 - Features
 - Applications
 - Functional Block Diagram
- **Port Configuration and Functions**
 - Port Diagram
 - Port Functions
- **Revision History**
- **Specifications**
 - Absolute Maximum Ratings
 - Package Information
 - Recommended Operating Conditions
 - Sequencing Requirements
 - Electrical Specifications
 - Typical Performance Plots
 - Typical Performance Plots: IP3
 - Typical Performance Plots: LO Harmonic Isolation
 - Typical Performance Plots: Tuner Mixer
 - MM1-1467HUB Typical Performance Plots
 - MM1-1467HUB Typical Performance Plots: IP3
 - MM1-1467HUB Typical Performance Plots: LO Harmonic Isolation
 - MM1-1467HUB Typical Performance Plots: Tuner Mixer
 - Spur Tables
- **Die Mounting Recommendations**
 - Mounting and Bounding Recommendations
- **Mechanical Data**
 - Outline Drawing

Revision History

Revision Code	Revision Date	Comment
-	2019-05-01	Datasheet Initial Release

Port Configuration and Functions

Port Diagram

The MM1-1467HCH-1 is shown below to the right. Both mixers are electrically identical and have mirrored footprints. The MM1-1467H has the input and output ports given in Port Functions. The MM1-1467H can be used in either an up or down conversion.

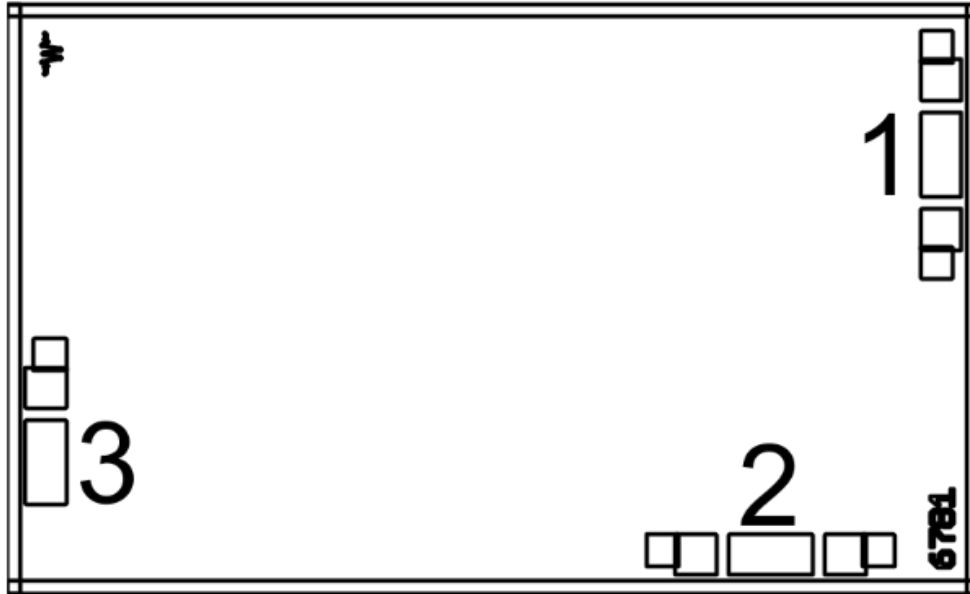

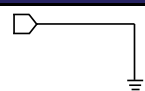
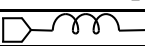
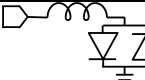
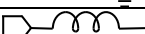

Port Functions

Configuration A

Port	Function	Description	Equivalent Circuit for Package
GND	Ground	CH package ground path is provided through the substrate and ground bond pads.	
Port 1	LO	Port 1 is DC open for the CH and UB packages.	
Port 2	IF	Port 2 is diode connected for the CH and UB package.	
Port 3	RF	Port 3 is DC open for the CH and UB packages.	

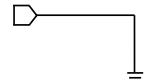
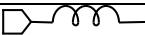
Configuration B

Port	Function	Description	Equivalent Circuit for Package
GND	Ground	CH package ground path is provided through the substrate and ground bond pads.	
Port 1	RF	Port 1 is DC open for the CH and UB packages.	
Port 2	IF	Port 2 is diode connected for the CH and UB package.	
Port 3	LO	Port 3 is DC open for the CH and UB packages.	

Specifications

Absolute Maximum Ratings

The Absolute Maximum Ratings indicate limits beyond which damage may occur to the device. If these limits are exceeded, the device may be inoperable or have a reduced lifetime.

Parameter	Maximum Rating	Unit
Maximum Operating Temperature	100	°C
Maximum Storage Temperature	125	°C
Minimum Operating Temperature	-55	°C
Minimum Storage Temperature	-65	°C
Power Handling, at any Port	27	dBm

Package Information

Parameter	Details	Rating
ESD	250 to < 500 Volts	HBM Class 1A
Dimensions	-	2.28x1.38mm

Recommended Operating Conditions

The Recommended Operating Conditions indicate the limits, inside which the device should be operated, to guarantee the performance given in Electrical Specifications. Operating outside these limits may not necessarily cause damage to the device, but the performance may degrade outside the limits of the electrical specifications. For limits, above which damage may occur, see Absolute Maximum Ratings.

Parameter	Min	Nominal	Max	Unit
Ambient Temperature	-55	25	100	°C
LO Input Power	11	-	20	dBm

Sequencing Requirements

There is no requirement to apply power to the ports in a specific order. However, it is recommended to provide a 50Ω termination to each port before applying power. This is a passive diode mixer that requires no DC bias.

Electrical Specifications

The electrical specifications apply at TA=+25°C in a 50Ω system. Typical data shown is for the connectorized UB package mixer used with a +15 dBm sine wave LO. Min and Max limits apply only to our connectorized units and are guaranteed at TA=+25°C. All bare die are 100% DC tested and visually inspected.

Parameter	Port Configuration	Test Conditions	Min	Typ	Max	Unit
Conversion Loss ¹	A	RF/LO = 14 - 67 GHz I = 0.091- 21 GHz	-	9	-	dB
Input 1 dB Gain Compression Point (P1dB)	A	-	-	9	-	dBm
Input IP3	A	RF/LO = 14 - 67 GHz I = 0.091 GHz	-	17.5	-	dBm
Input 1 dB Gain Compression Point (P1dB)	B	-	-	3.5	-	dBm
Input IP3	B	RF/LO = 14 - 67 GHz I = 0.091 GHz	-	19.5	-	dBm
IF Frequency Range	-	-	0	-	21	GHz
Isolation, LO to IF	-	IF/LO = 14 - 67 GHz	-	33	-	dB
Isolation, LO to RF	-	RF/LO = 14 - 67 GHz	-	53	-	dB
Isolation, RF to IF	-	RF/IF = 14 - 67 GHz	-	48	-	dB
LO Frequency Range	-	-	14	-	67	GHz
Noise Figure ²	-	RF/LO = 14 - 67 GHz I = 0.091- 21 GHz	-	8.5	-	dB
RF Frequency Range	-	-	14	-	67	GHz

^[1] Measured as a down converter to a fixed 91 MHz IF. Unless otherwise stated, frequency conversion done using a highside LO.

^[2] Mixer Noise Figure typically measures within 0.5 dB of conversion loss for IF frequencies greater than 5 MHz.

Typical Performance Plots

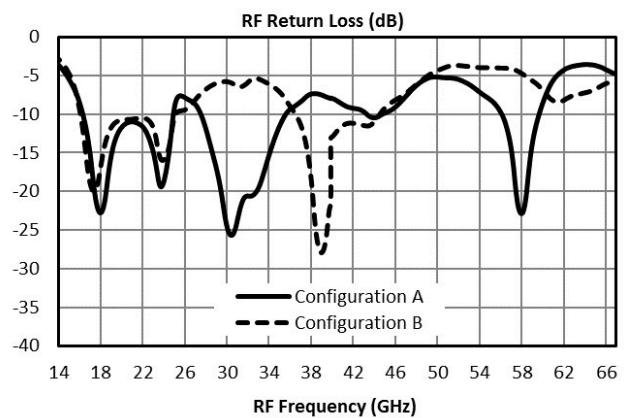
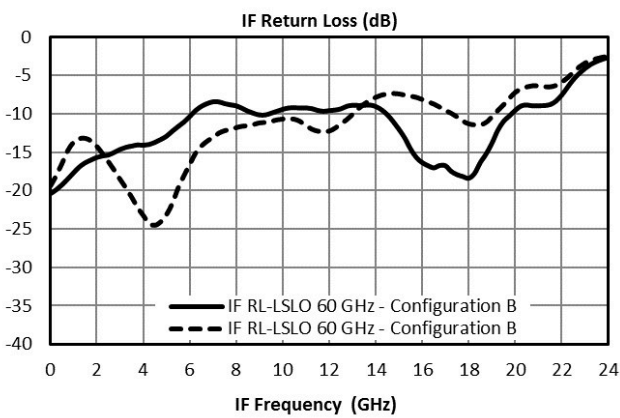
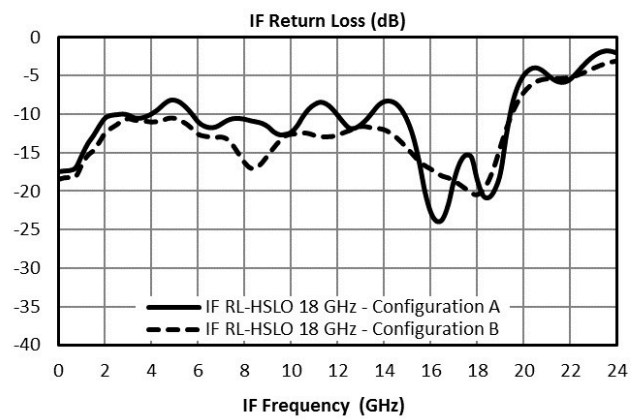
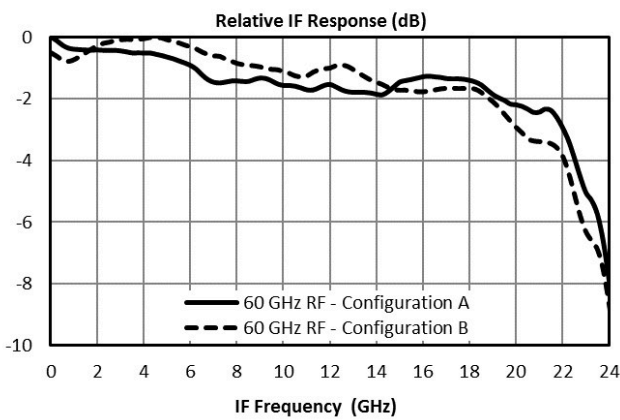
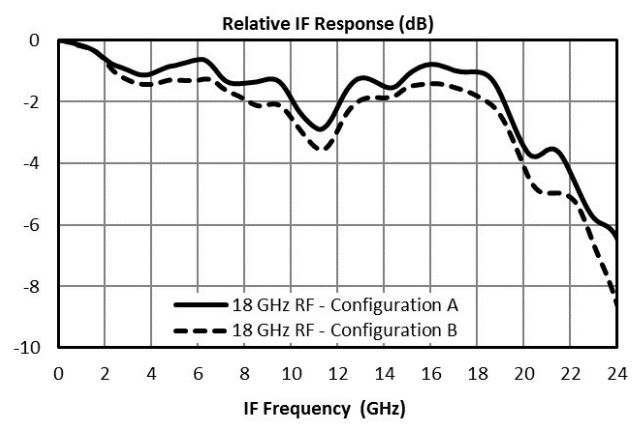
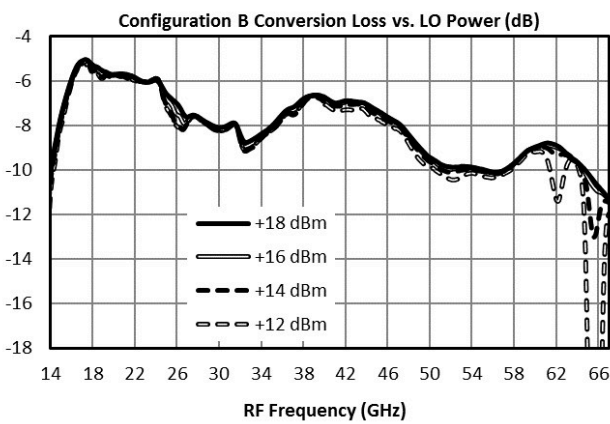
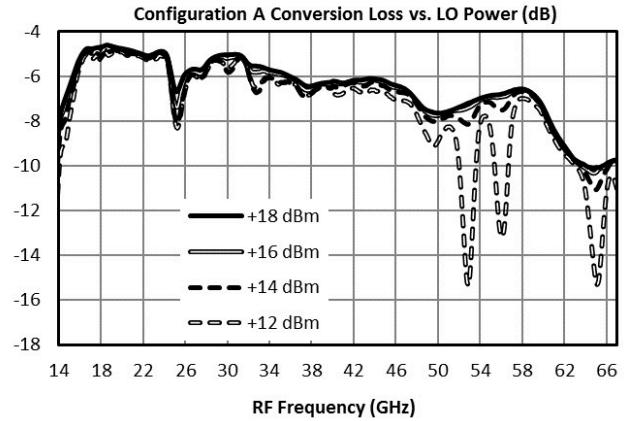
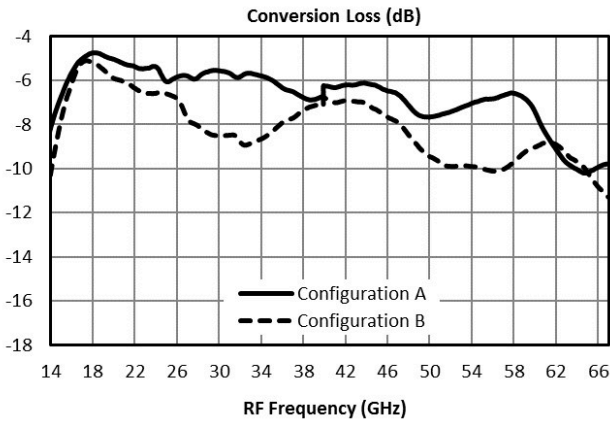

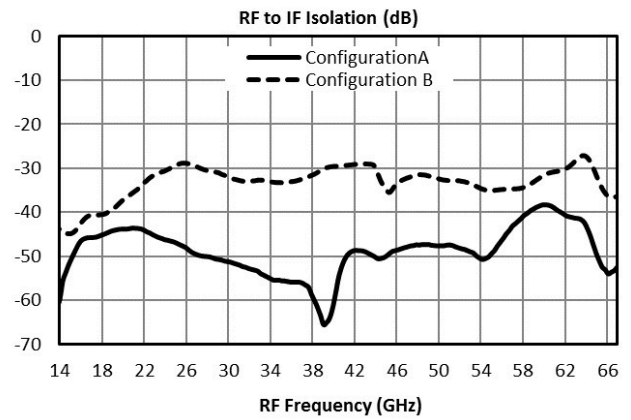
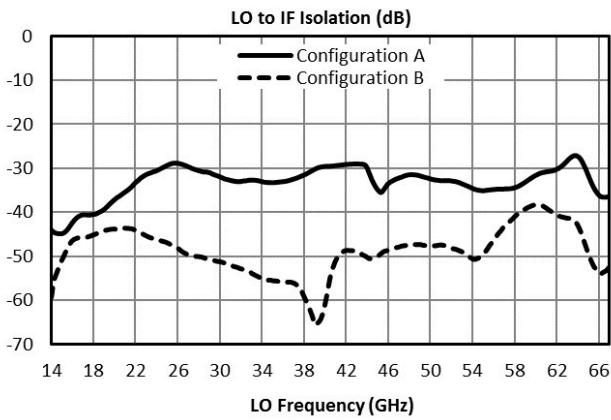
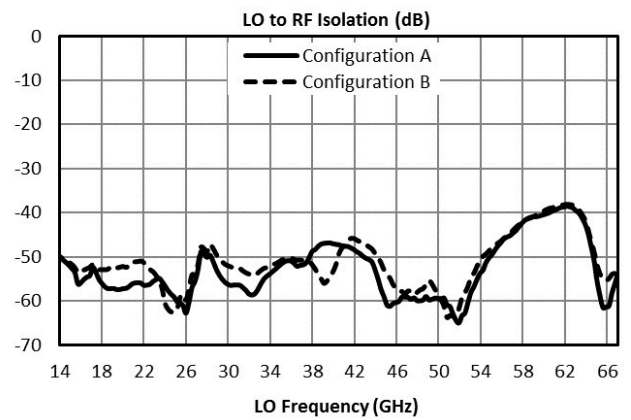
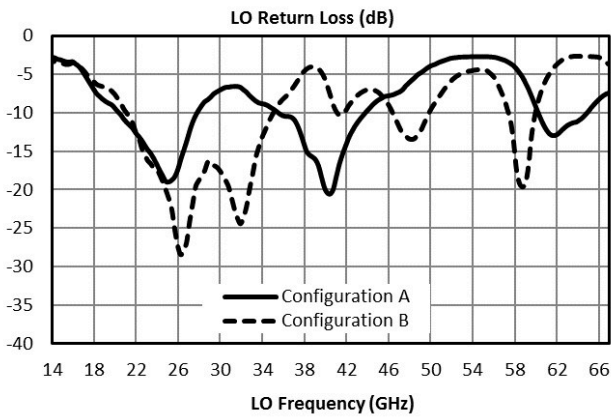

Typical Performance Plots: IP3

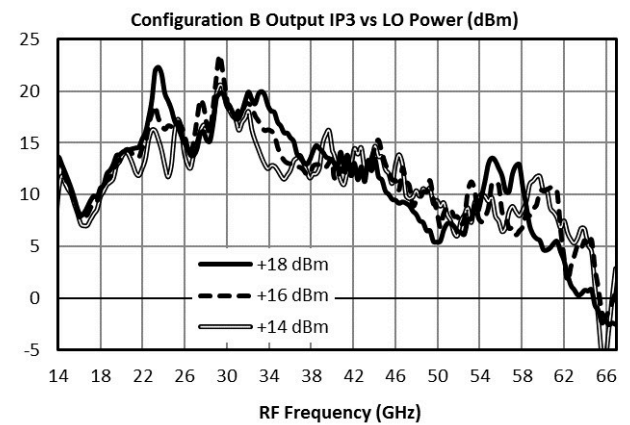
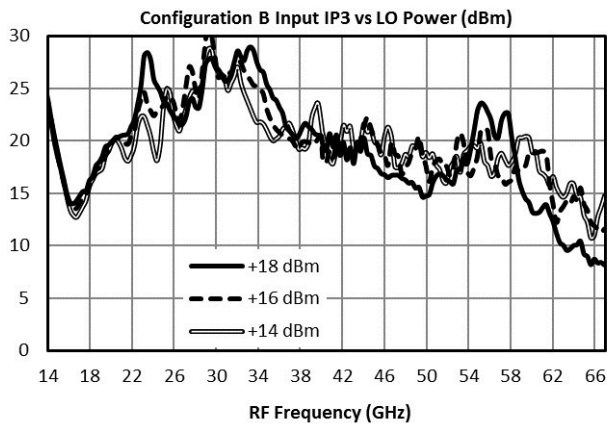
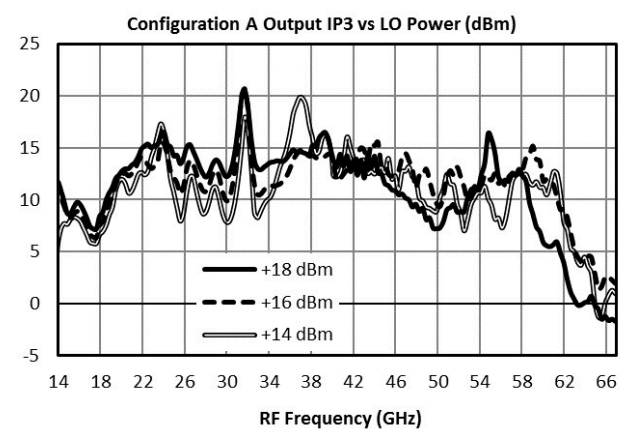
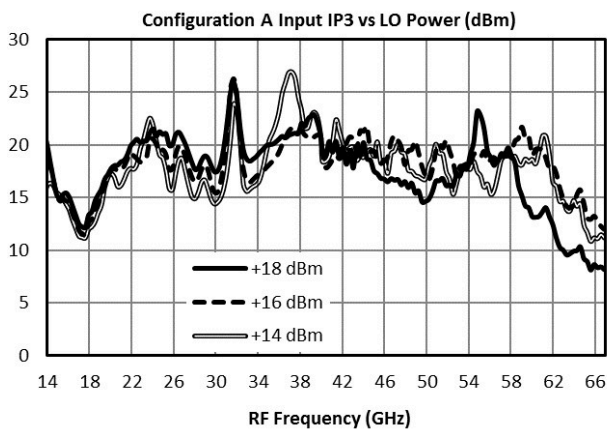
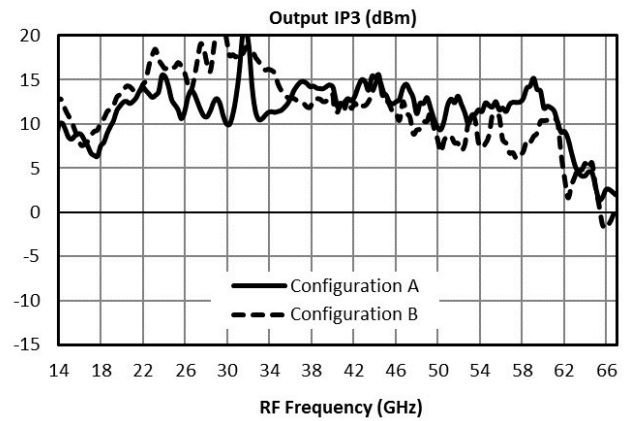
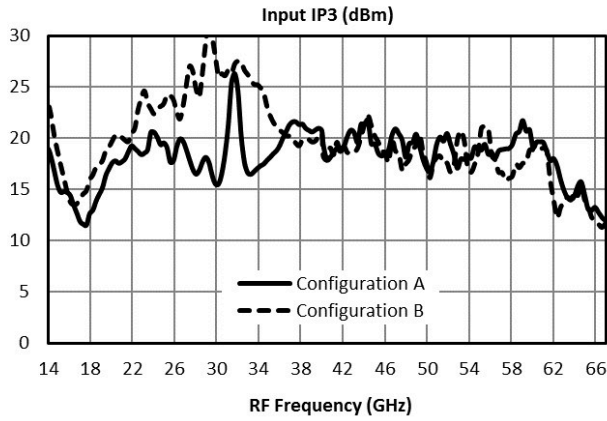

Typical Performance Plots: LO Harmonic Isolation

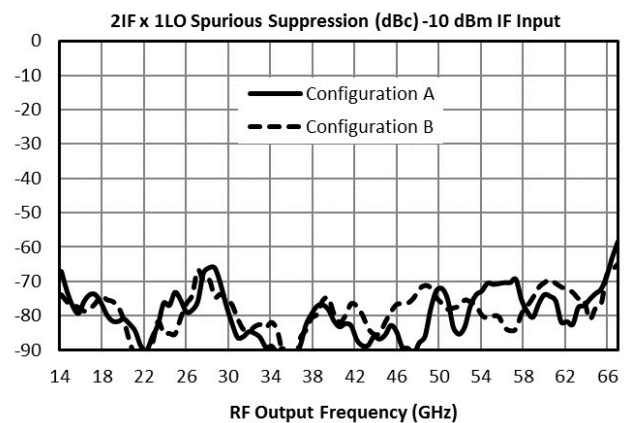
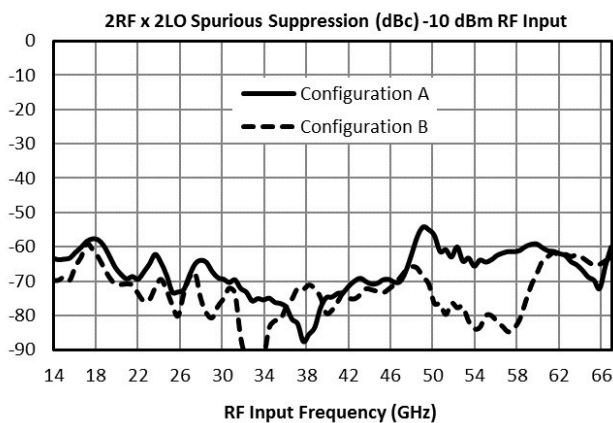
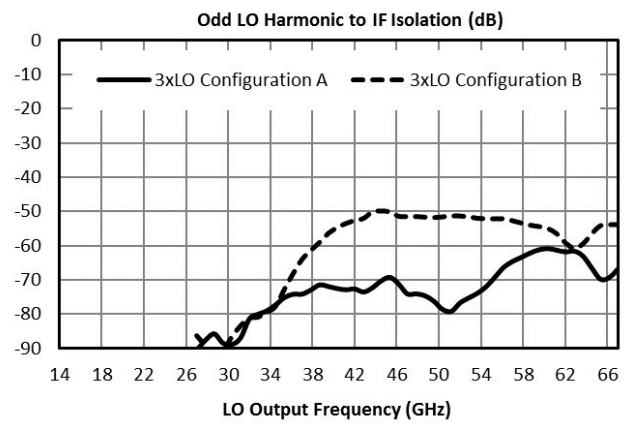
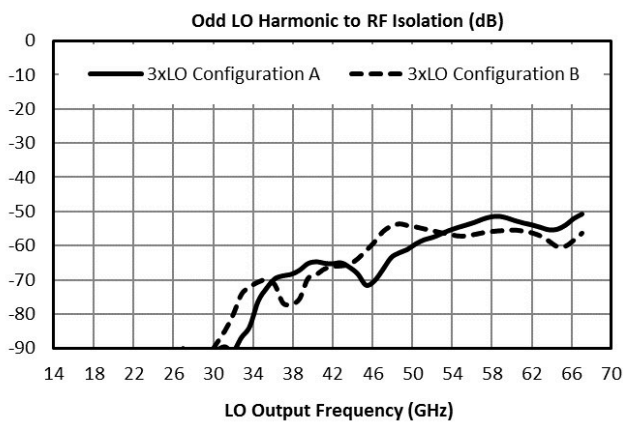
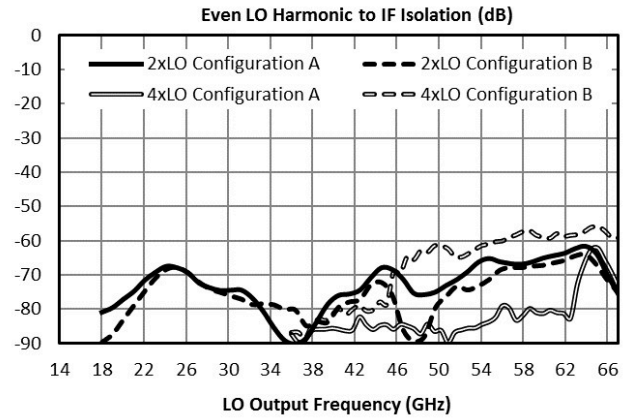
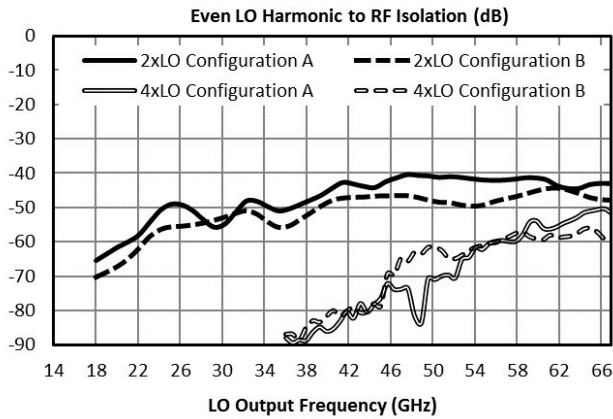

Typical Performance Plots: Tuner Mixer

Tuner mixer performance plots are taken with the following test conditions and frequency plan:

Parameter	Start	Nominal	Stop	Units
IF Input Frequency	0		24	GHz
IF Input Power		-10		dBm
LO Input Frequency	24		48	GHz
LO Input Power		+15		dBm
RF Output Frequency		24		GHz

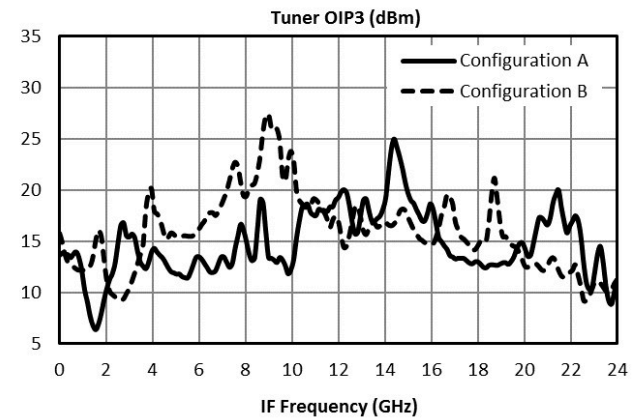
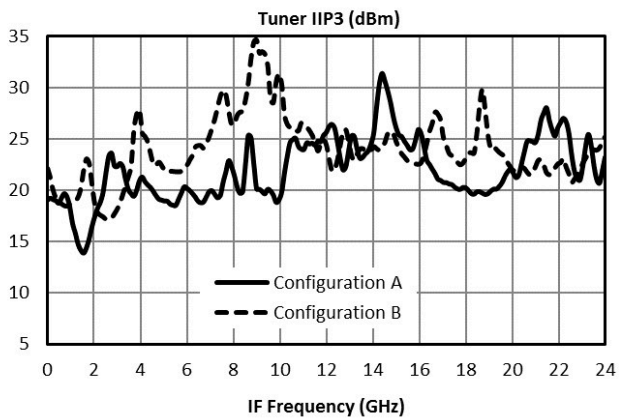
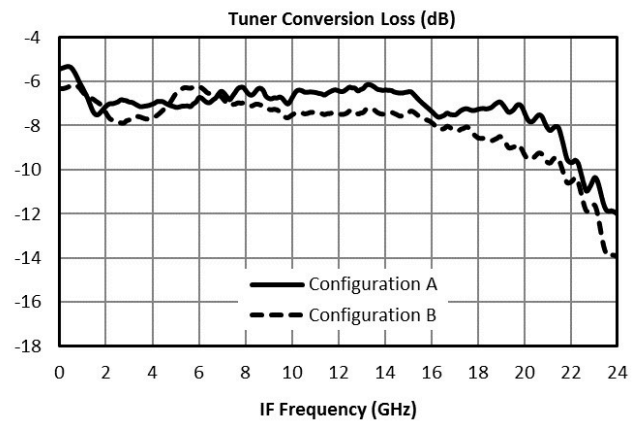
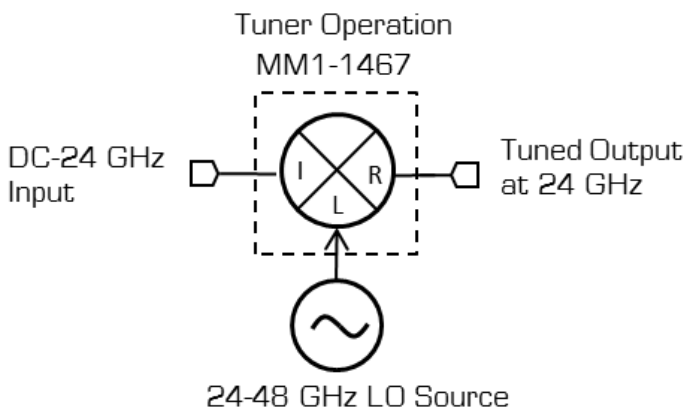

MM1-1467HUB - Typical Performance Plots

Performance plots for the connectorized module are shown for measurements where directly probed measurements of the die are unavailable. Note that the following measurements include losses from connectors and microstrip traces.

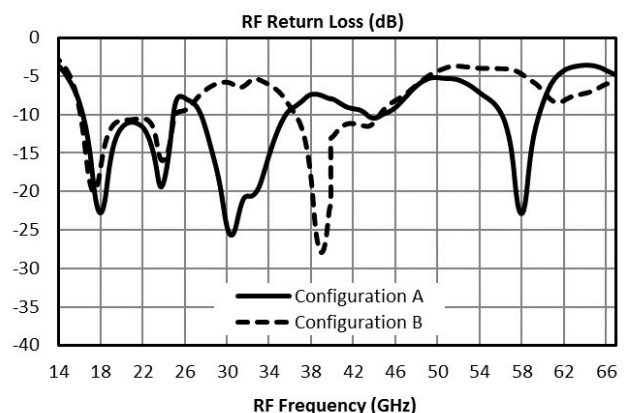
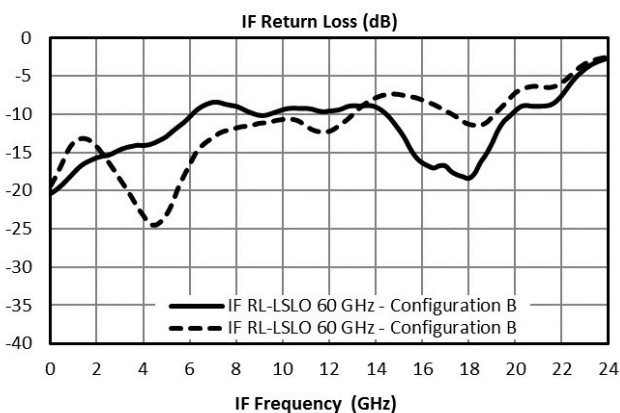
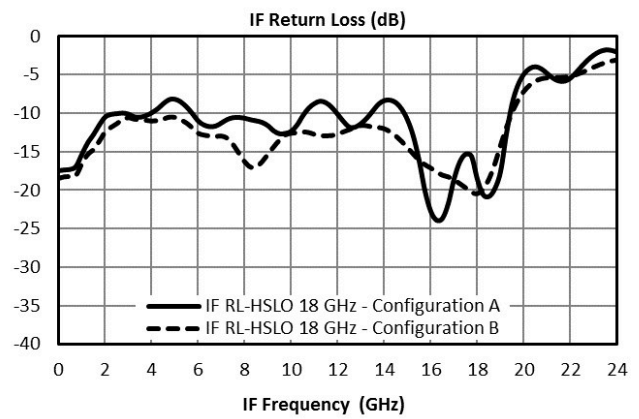
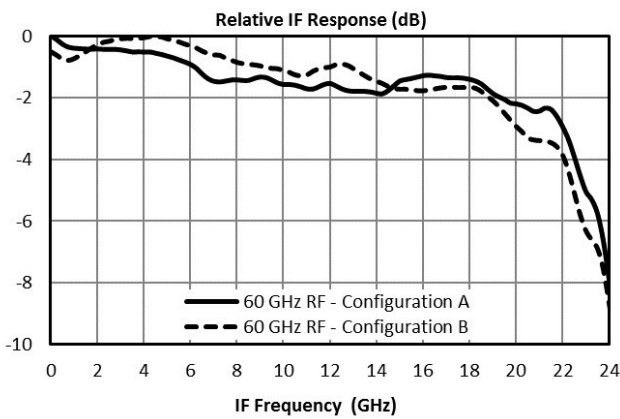
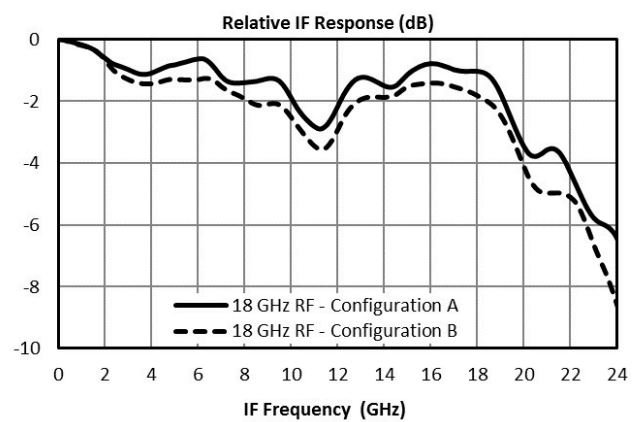
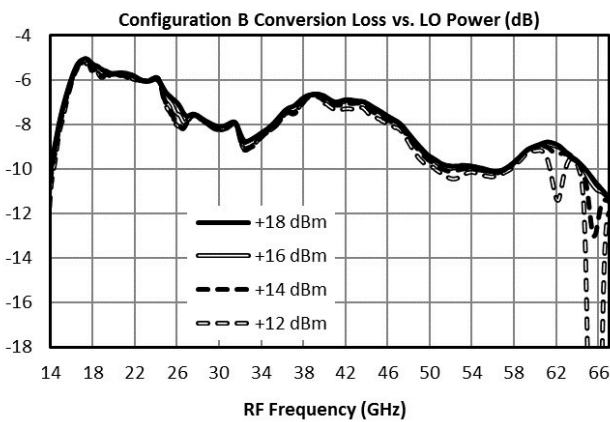
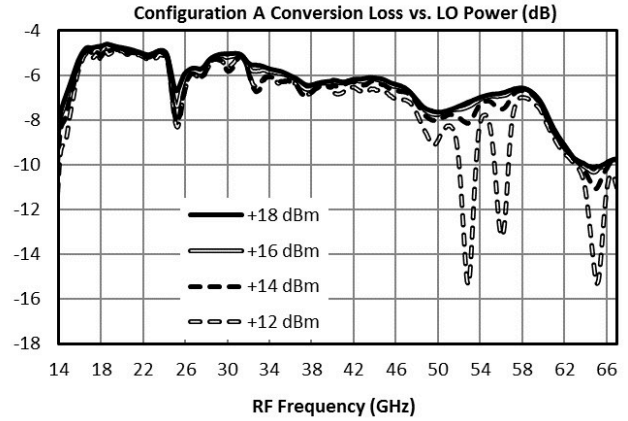
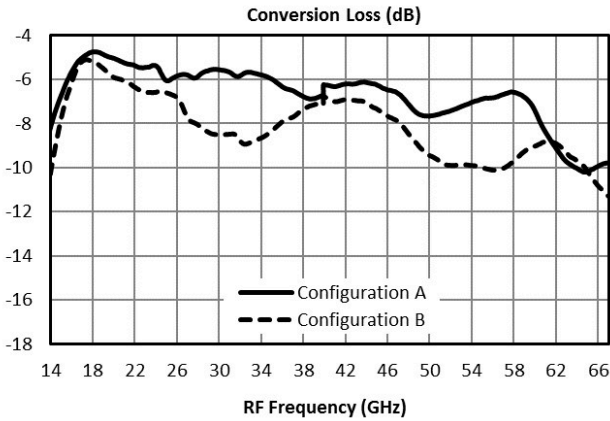

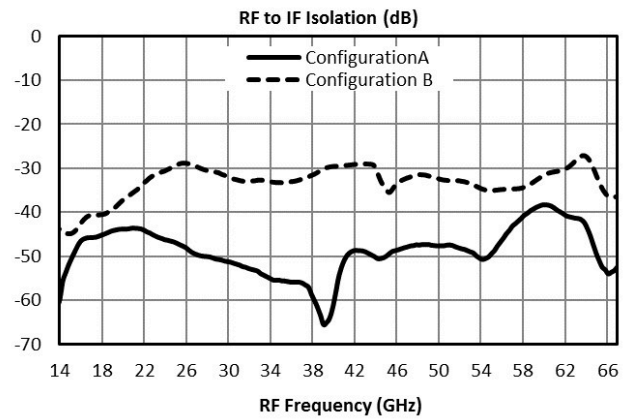
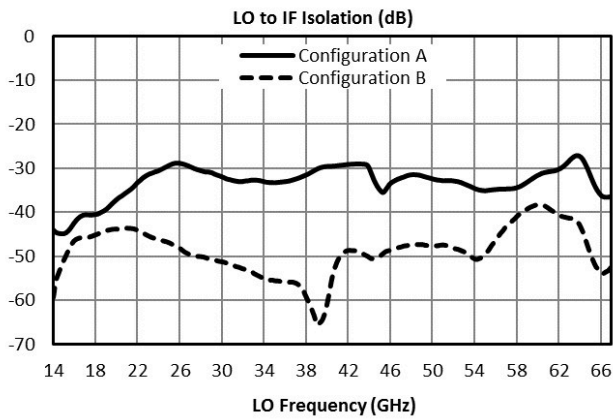
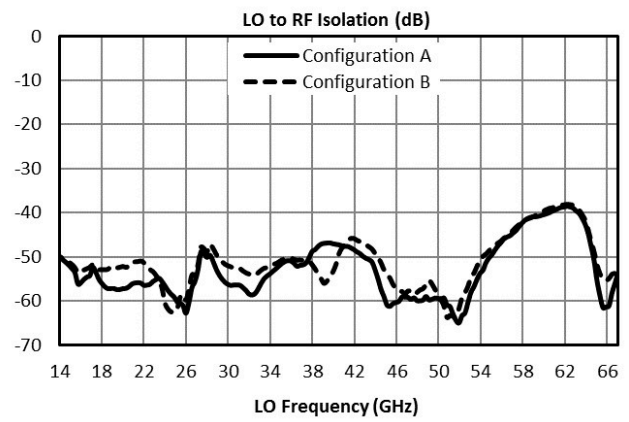
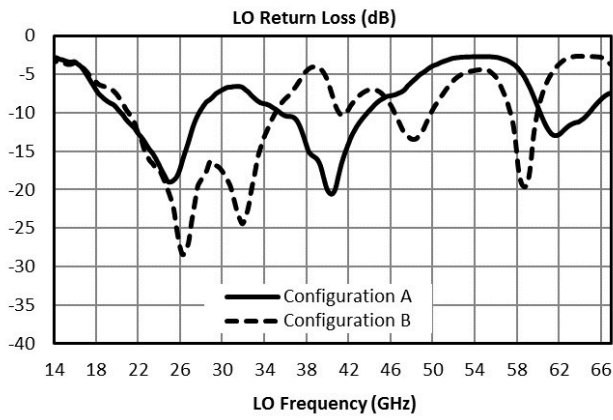

MM1-1467HUB - Typical Performance Plots: IP3

Performance plots for the connectorized module are shown for measurements where directly probed measurements of the die are unavailable. Note that the following measurements include losses from connectors and microstrip traces.

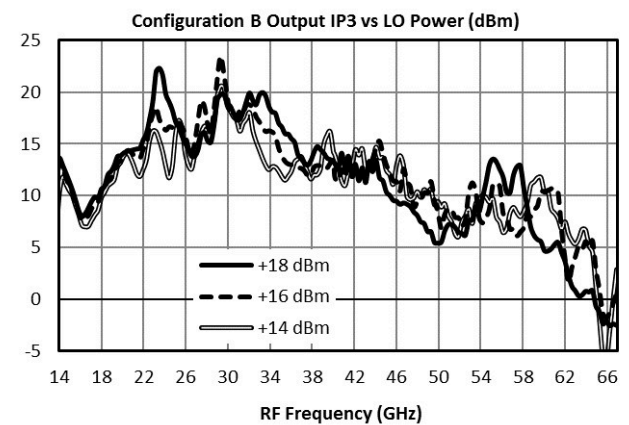
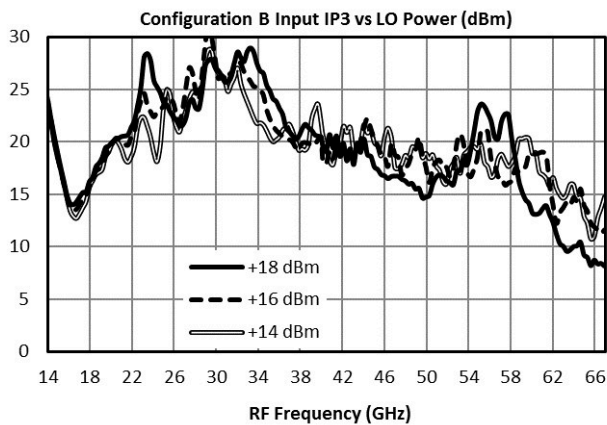
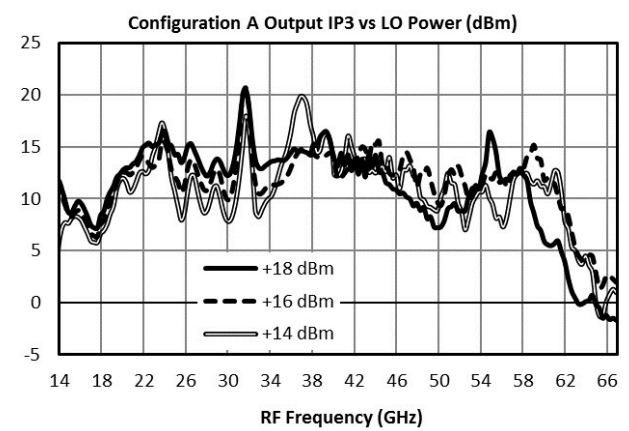
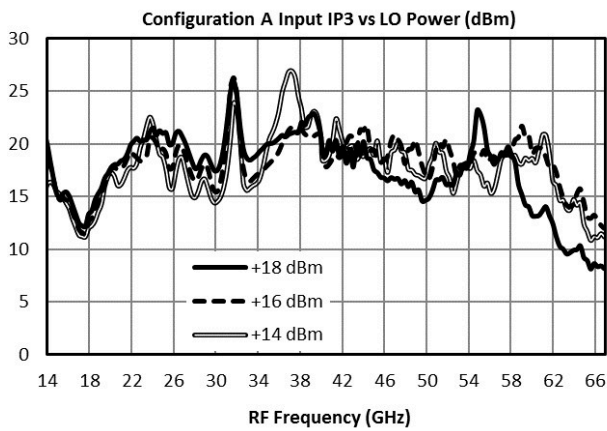
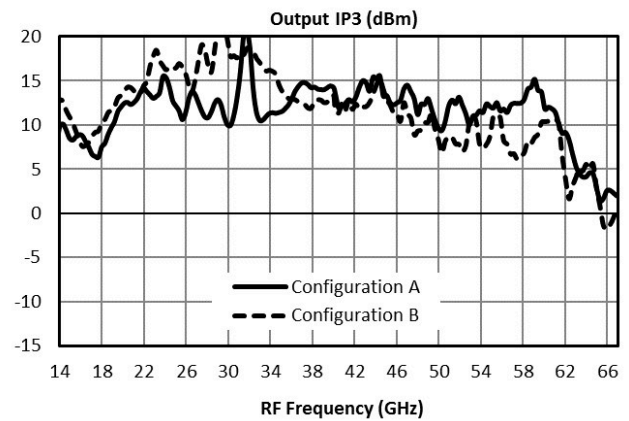
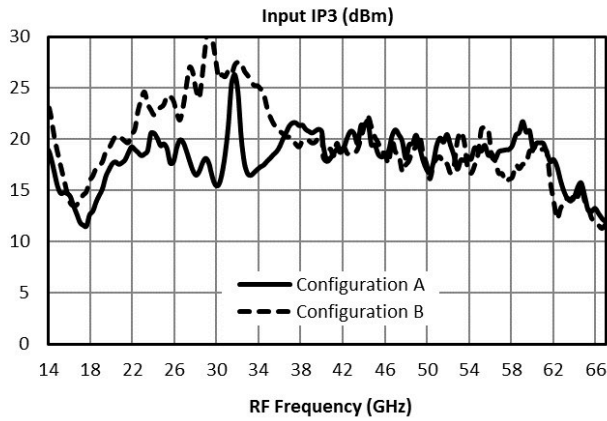

MM1-1467HUB - Typical Performance Plots: LO Harmonic Isolation

Performance plots for the connectorized module are shown for measurements where directly probed measurements of the die are unavailable. Note that the following measurements include losses from connectors and microstrip traces.

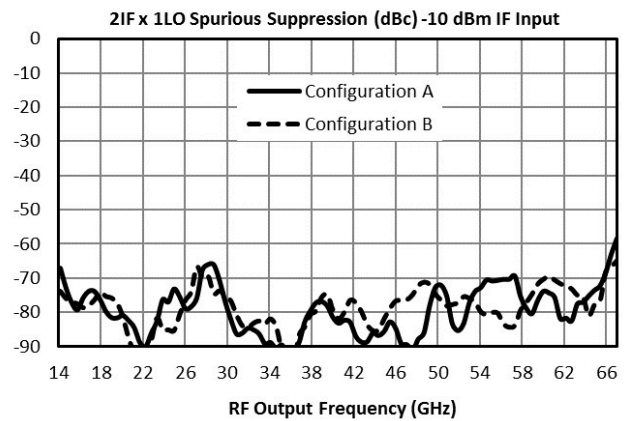
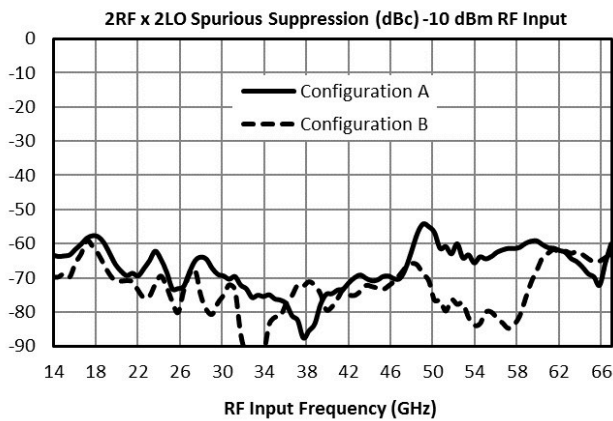
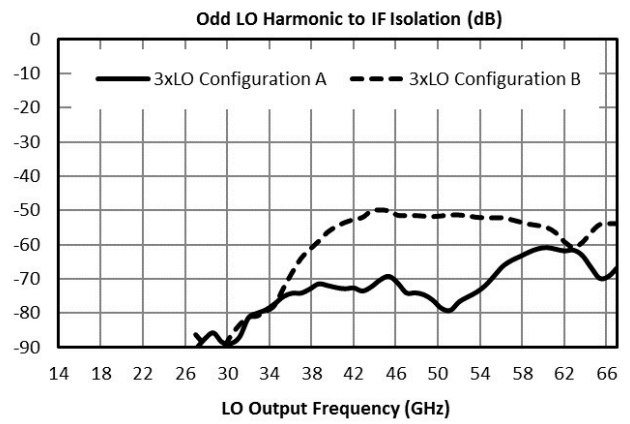
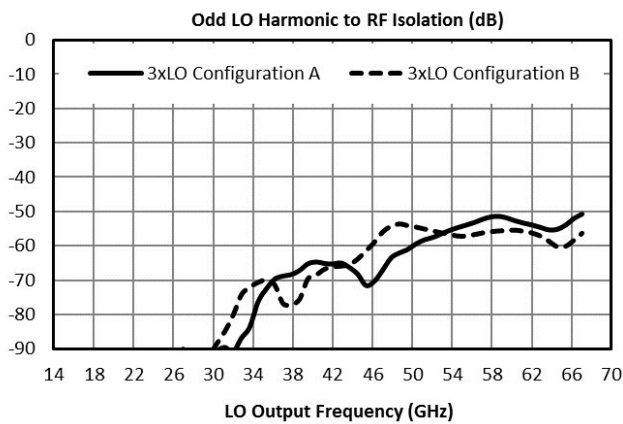
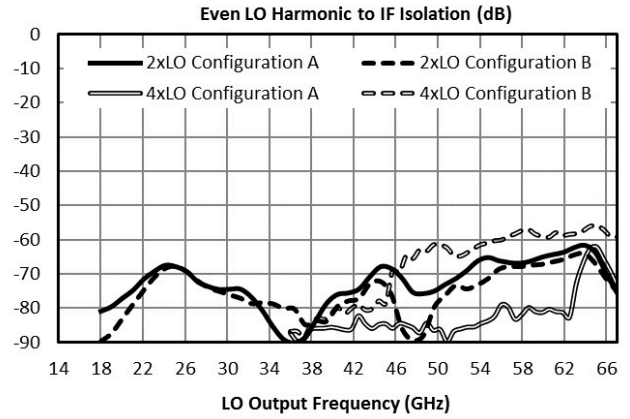
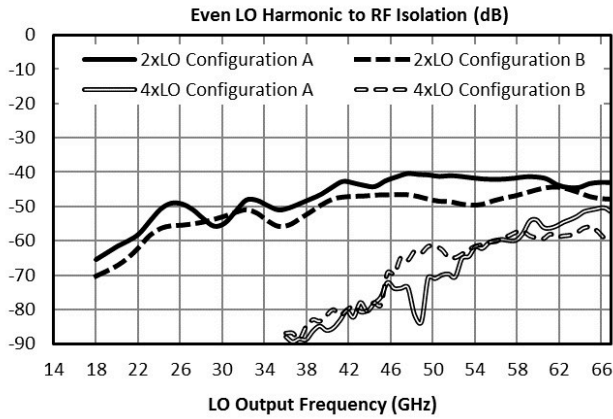

MM1-1467HUB - Typical Performance Plots: Tuner Mixer

Tuner mixer performance plots are taken with the following test conditions and frequency plan:

Parameter	Start	Nominal	Stop	Units
IF Input Frequency	0		24	GHz
IF Input Power		-10		dBm
LO Input Frequency	24		48	GHz
LO Input Power		+15		dBm
RF Output Frequency		24		GHz

Performance plots for the connectorized module are shown for measurements where directly probed measurements of the die are unavailable. Note that the following measurements include losses from connectors and microstrip traces.

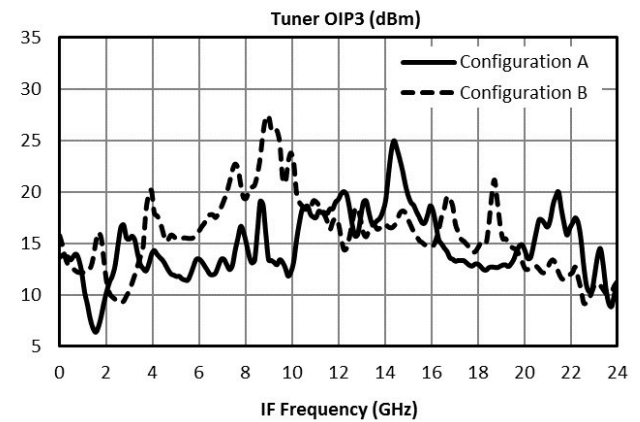
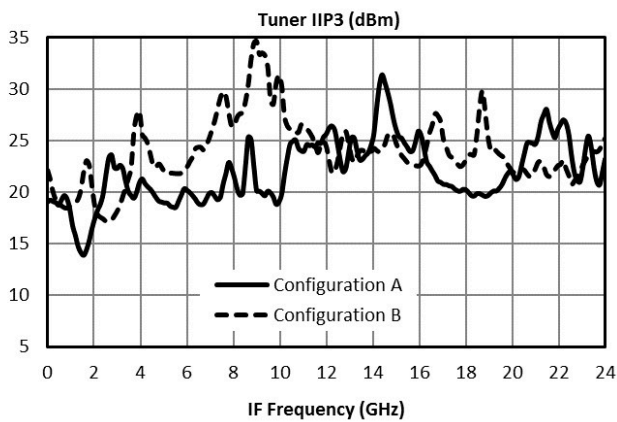
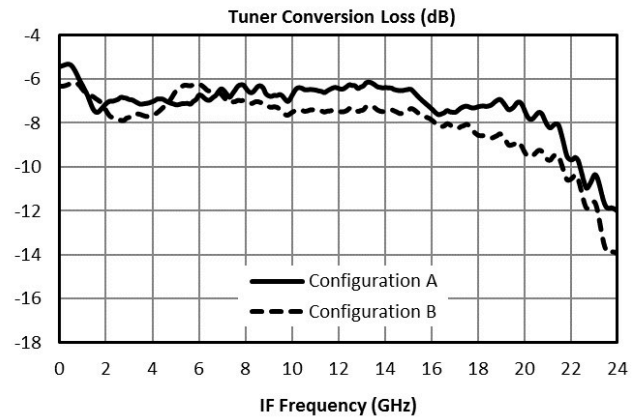
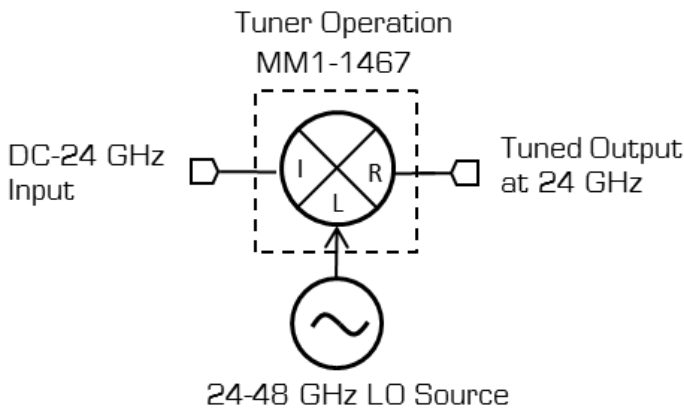

Spur Table

Typical Spurious Performance: Down-Conversion

Typical spurious data is provided by selecting RF and LO frequencies ($\pm m \cdot LO \pm n \cdot RF$) within the RF/LO bands, to create a spurious output within the IF band. The mixer is swept across the full spurious band and the mean is calculated. The numbers shown in the table below are for a -10 dBm RF input. Spurious suppression is scaled for different RF power levels by $(n-1)$, where “n” is the RF spur order. For example, the 2RF x 2LO spur is 67 dBc for a -10 dBm input, so a -20 dBm RF input creates a spur that is $(2-1) \times (-10 \text{ dB})$ lower, or 77 dBc.

 M M1 1467 Hch 1 Typical Down Conversion Spurious Suppression Config A

Typical Spurious Performance: Up-Conversion

Typical spurious data is taken by mixing an input within the IF band, with LO frequencies ($\pm m \cdot LO \pm n \cdot IF$), to create a spurious output within the RF output band. The mixer is swept across the full spurious output band and the mean is calculated. The numbers shown in the table below are for a -10 dBm IF input. Spurious suppression is scaled for different IF input power levels by (n-1), where “n” is the IF spur order. For example, the 2IFx1LO spur is typically 79 dBc for a -10 dBm input with a sine-wave LO, so a -20 dBm IF input creates a spur that is (2-1) x (-10 dB) lower, or 89 dBc.

Typical Up-conversion spurious suppression (dBc): Config A (B)

-10 dBm RF Input	0xLO	1xLO	2xLO	3xLO	4xLO	5xLO
1xIF	40 (25)	Reference	40 (34)	17 (14)	42 (34)	N/A
2xIF	70 (70)	79 (79)	68 (71)	74 (76)	57 (67)	77 (74)
3xIF	89 (80)	61 (69)	82 (79)	65 (64)	77 (72)	54 (58)
4xIF	109 (111)	106 (109)	106 (108)	105 (104)	89 (99)	102 (105)
5xIF	121 (119)	105 (110)	120 (121)	103 (107)	114 (112)	98 (104)

Die Mounting Recommendations

Mounting and Bonding Recommendations

Marki MMICs should be attached directly to a ground plane with conductive epoxy. The ground plane electrical impedance should be as low as practically possible. This will prevent resonances and permit the best possible electrical performance. Datasheet performance is only guaranteed in an environment with a low electrical impedance ground.

Mounting - To epoxy the chip, apply a minimum amount of conductive epoxy to the mounting surface so that a thin epoxy fillet is observed around the perimeter of the chip. Cure epoxy according to manufacturer instructions.

Wire Bonding - Ball or wedge bond with 0.025 mm (1 mil) diameter pure gold wire. Thermosonic wirebonding with a nominal stage temperature of 150 °C and a ball bonding force of 40 to 50 grams or wedge bonding force of 18 to 22 grams is recommended. Use the minimum level of ultrasonic energy to achieve reliable wirebonds. Wirebonds should be started on the chip and terminated on the package or substrate. All bonds should be as short as possible <0.31 mm (12 mils).

Circuit Considerations – 50 Ω transmission lines should be used for all high frequency connections in and out of the chip. Wirebonds should be kept as short as possible, with multiple wirebonds recommended for higher frequency connections to reduce parasitic inductance. In circumstances where the chip more than .001” thinner than the substrate, a heat spreading spacer tab is optional to further reduce bondwire length and parasitic inductance.

Handling Precautions

General Handling

Chips should be handled with care using tweezers or a vacuum collet. Users should take precautions to protect chips from direct human contact that can deposit contaminants, like perspiration and skin oils on any of the chip's surfaces.

Static Sensitivity

GaAs MMIC devices are sensitive to ESD and should be handled, assembled, tested, and transported only in static protected environments.

Cleaning and Storage: Do not attempt to clean the chip with a liquid cleaning system or expose the bare chips to liquid. Once the ESD sensitive bags the chips are stored in are opened, chips should be stored in a dry nitrogen atmosphere.

Bonding Diagram

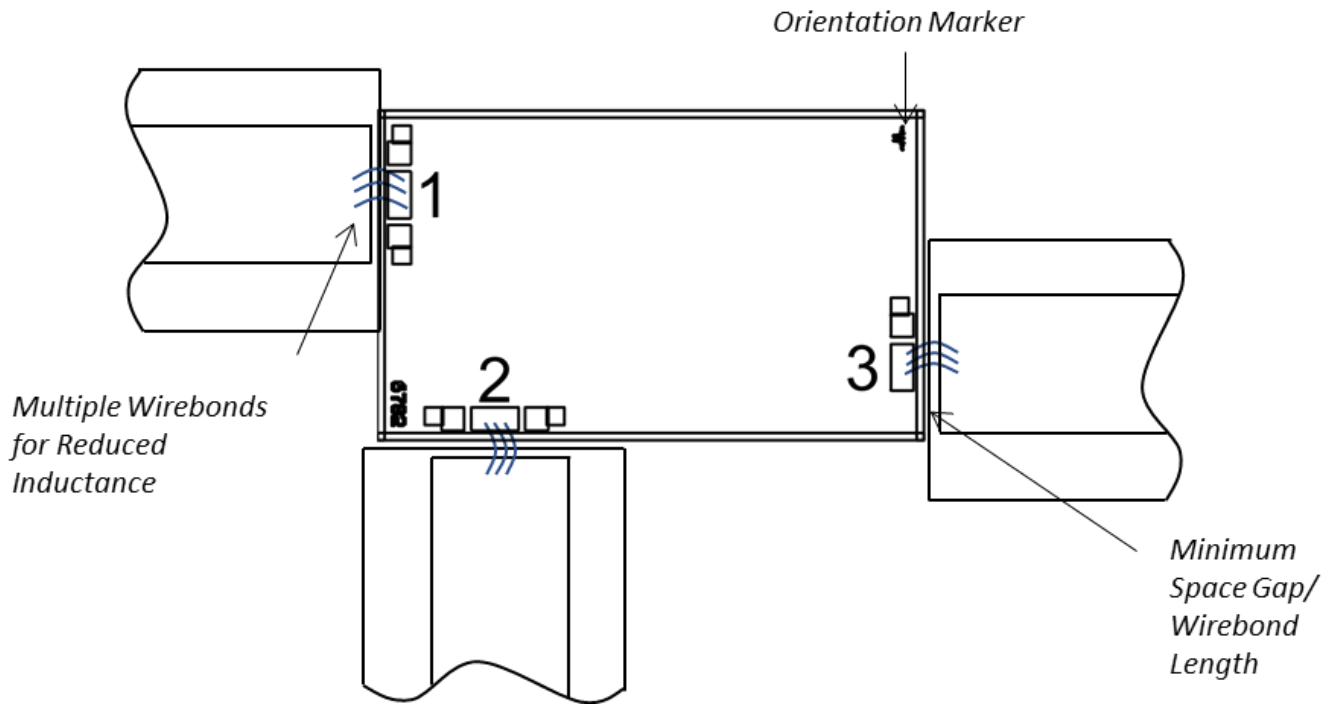

DISCLAIMER

MARKI MICROWAVE, INC., ("MARKI") PROVIDES TECHNICAL SPECIFICATIONS AND DATA (INCLUDING DATASHEETS), APPLICATION OR OTHER DESIGN ADVICE, WEB TOOLS, AND OTHER INFORMATION AND RESOURCES "AS IS" AND WITH ALL FAULTS. MARKI DISCLAIMS ALL WARRANTIES, EXPRESS OR IMPLIED, INCLUDING, WITHOUT LIMITATION, ANY IMPLIED WARRANTIES OF MERCHANTABILITY, FITNESS FOR A PARTICULAR PURPOSE, OR NON-INFRINGEMENT. These resources are intended for developers skilled in the art designing with Marki products. You are solely responsible for (1) selecting the appropriate products for your application, (2) designing, validating, and testing your application, and (3) ensuring your application meets applicable standards and other requirements. Marki makes no guarantee regarding the suitability of its products for any particular purpose, nor does Marki assume any liability whatsoever arising out of your use or application of any Marki product.

Marki grants you permission to use these resources only for development of an application that uses Marki products. Other reproduction or use of these resources is strictly prohibited. No license is granted to any other Marki intellectual property or to any third-party intellectual property. Marki reserves the right to make changes to the product(s) or information contained herein without notice.

MARKI MICROWAVE and T3 MIXER are trademarks or registered trademarks of Marki Microwave, Inc. All other trademarks used are the property of their respective owners.

© 2019, Marki Microwave, Inc