

# MMQ-40125HCH

## GaAs MMIC Millimeter Wave 4x Multiplier

### DEVICE OVERVIEW

#### General Description

MMQ-40125H is a MMIC millimeter wave 4x multiplier fabricated with GaAs Schottky diodes. MMQ-40125H operates over a 10 to 31.25 GHz input frequency range or a quadrupled output frequency range of 40 to 125 GHz. Operation past 125GHz is pending verification. Contact factory for information. MMQ-40125H is available as a connectorized coaxial module using 1.0 mm connectors on the output. Wire bondable die are also available.

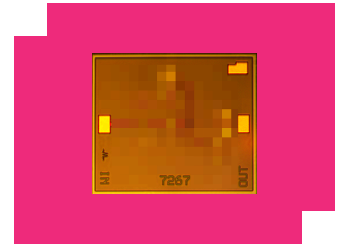

#### Features

- Low loss die and package
- Up to 125GHz 4th harmonic output tone
- Convenient +0 dBm output level
- Coax connector module

#### Applications

- mmWave frequency synthesis
- LO signal chain for mmWave mixers

#### Functional Block Diagram

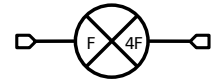

#### Part Ordering Options

Part Number	Description	Package	Connectors	Green Status	Product Lifecycle	Export Classification
<u>MMQ-40125HM</u>	GaAs MMIC Millimeter Wave 4x Multiplier	M	<u>Standard</u>	REACH RoHS	Released	EAR99
MMQ-40125HCH	GaAs MMIC Millimeter Wave 4x Multiplier	CH	-	REACH RoHS	Released	EAR99

**Table Of Contents**

- **Device Overview**
  - General Description
  - Features
  - Applications
  - Functional Block Diagram
- **Port Configuration and Functions**
  - Port Diagram
  - Port Functions
- **Revision History**
- **Specifications**
  - Absolute Maximum Ratings
  - Package Information
  - Recommended Operating Conditions
  - Sequencing Requirements
  - Electrical Specifications
  - Typical Performance Plots
  - MMQ-40125HM Typical Performance Plots
- **Die Mounting Recommendations**
  - Mounting and Bounding Recommendations
- **Mechanical Data**
  - Outline Drawing

**Revision History**

Revision Code	Revision Date	Comment
-	2020-10-01	Initial Datasheet Release
A	2021-06-01	Export Classification Updated
B	2024-03-14	Export Classification Updated



## Port Configuration and Functions

### Port Diagram

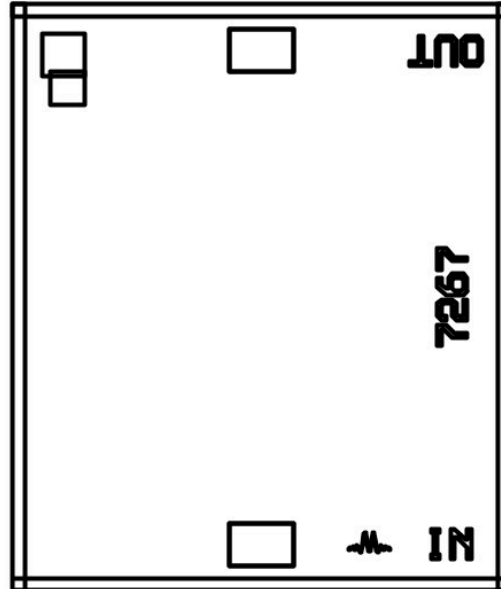
A top-down view of the MMQ-40125H's CH package outline drawing is shown below

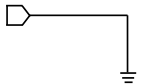

### Port Functions

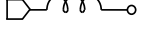
Port	Function	Description	DC Equivalent Circuit
GND	Ground	CH package ground path is provided through the substrate and ground bond pads.	
Port 1	Input	Input 1x Frequency Port. Port 1 is DC coupled to the diodes for the CH and M packages. Blocking capacitor is optional.	
Port 2	Output	Port 2 is DC open for the CH and M package. 2x Input Frequency output port.	

## Specifications

### Absolute Maximum Ratings

The Absolute Maximum Ratings indicate limits beyond which damage may occur to the device. If these limits are exceeded, the device may be inoperable or have a reduced lifetime.

Parameter	Maximum Rating	Unit
Maximum Operating Temperature	100	°C
Maximum Storage Temperature	125	°C
Minimum Operating Temperature	-55	°C
Minimum Storage Temperature	-65	°C
Port 1 DC Current	25	mA
Power Handling, any Port	25	dBm

### Package Information

Parameter	Details	Rating
Dimensions	-	1.17 x 1.38 mm

### Recommended Operating Conditions

The Recommended Operating Conditions indicate the limits, inside which the device should be operated, to guarantee the performance given in Electrical Specifications. Operating outside these limits may not necessarily cause damage to the device, but the performance may degrade outside the limits of the electrical specifications. For limits, above which damage may occur, see Absolute Maximum Ratings.

Parameter	Min	Nominal	Max	Unit
Input Power	-	20	23	dBm
Ambient Temperature	-55	25	100	°C

### Sequencing Requirements

There is no requirement to apply power to the ports in a specific order. However, it is recommended to provide a 50Ω termination to each port before applying power. This is a passive diode doubler that requires no DC bias.

## Electrical Specifications

The electrical specifications apply at TA=+25°C in a 50Ω system. Typical data shown is for the connectorized M package quadrupler used in the forward direction with a nominal +20 dBm sine wave input. Min and Max limits apply only to our connectorized units and are guaranteed at TA=+25°C. RF testing of our die is performed on a sample basis to verify conformance to datasheet guaranteed specifications.

Parameter	Test Conditions	Minimum Frequency (GHz)	Maximum Frequency (GHz)	Min	Typ	Max	Unit
Conversion Loss	Input = 10 – 12.5 GHz Output = 40 - 50 GHz	-	-	-	28	-	dB
Conversion Loss	Input = 12.5 - 15 GHz Output = 50 - 60 GHz	-	-	-	23	-	dB
Conversion Loss	Input = 15 - 27.5 GHz Output = 60 - 110 GHz	-	-	-	20	23	dB
Conversion Loss	Input = 27.5 - 31.25 GHz Output = 110 - 125 GHz	-	-	-	25	-	dB
Input Frequency Range	-	-	-	10	-	31.25	GHz
Input Power	-	-	-	-	20	23	dBm
Isolation, 1F <sup>1</sup>	Input = 10 – 31.25 GHz Output = 10 – 31.25 GHz	-	-	-	41	-	dB
Isolation, 2F <sup>2</sup>	Input = 10 – 31.25 GHz Output = 20 – 62.5 GHz	-	-	-	38	-	dB
Isolation, 3F <sup>3</sup>	Input = 10 – 31.25 GHz Output = 30 – 93.75 GHz	-	-	-	34.5	-	dB
Output Frequency Range <sup>4</sup>	-	-	-	40	-	125	GHz
Suppression, 1F <sup>5</sup>	Input = 10 – 31.25 GHz Output = 10 – 31.25 GHz	-	-	-	19	-	dBc
Suppression, 2F <sup>6</sup>	Input = 10 – 31.25 GHz Output = 20 – 62.5 GHz	-	-	-	17	-	dBc
Suppression, 3F <sup>7</sup>	Input = 10 – 31.25 GHz Output = 30 – 93.75 GHz	-	-	-	12	-	dBc

[1][2][3] Isolation is defined as the harmonic power relative to the 1F fundamental input power.

[4] Output return loss measured with a fixed frequency large signal 31.25 GHz input.

[5] Suppressions and isolations figures reported include measurement amplifier's harmonic's leakage tones. Suppression is defined as the harmonic power relative to the 4F quadrupled output power.

[6][7] Suppressions and isolations figures reported include measurement amplifier's harmonic's leakage tones. Suppression is defined as the harmonic power relative to the 4F quadrupled output power.

**Typical Performance Plots**

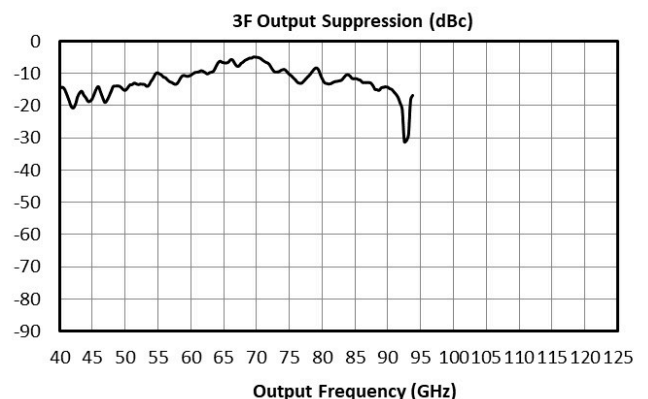
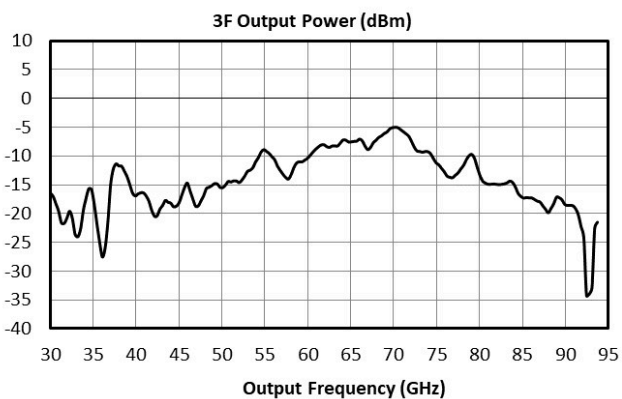
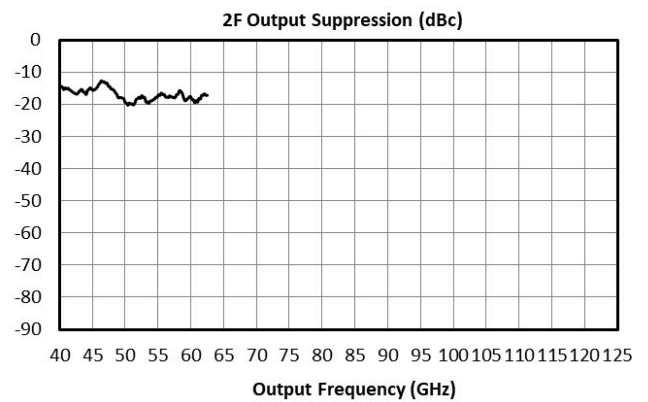
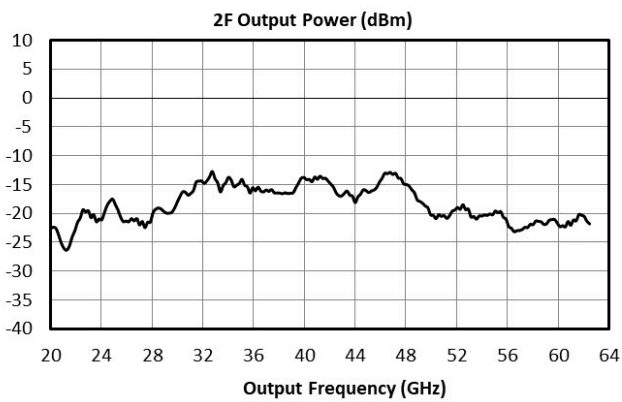
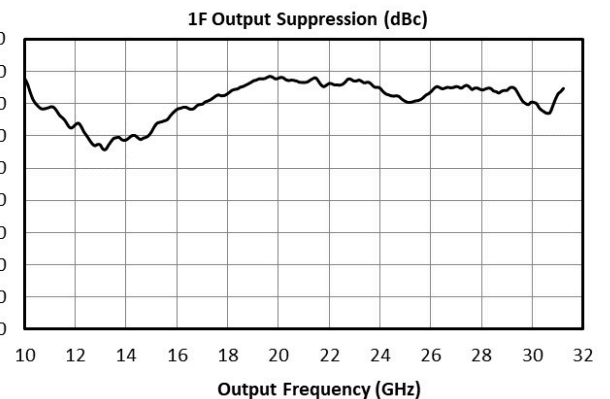
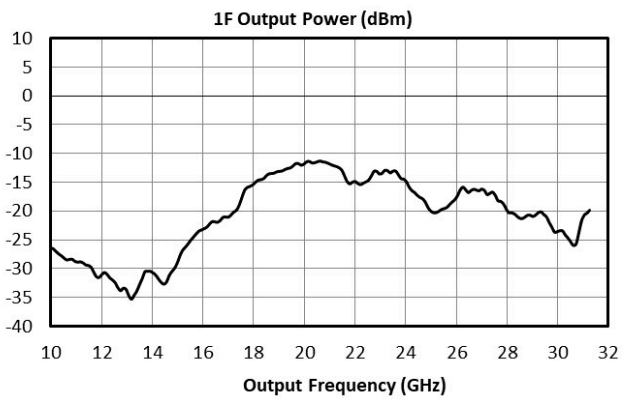
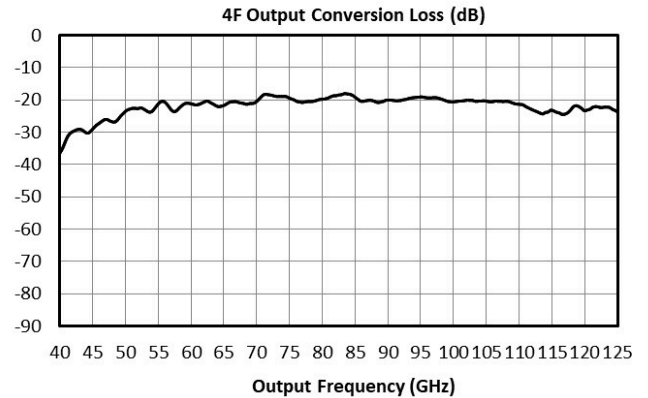
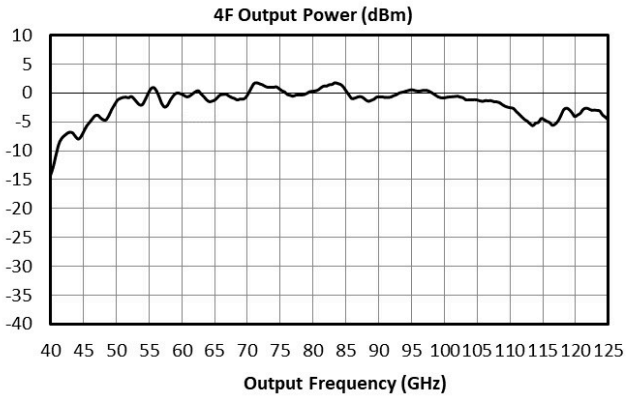

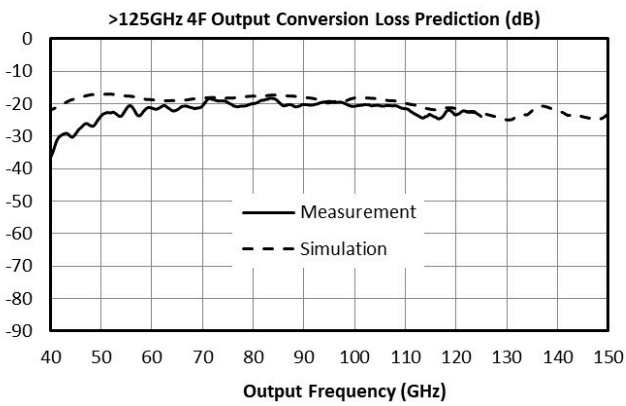
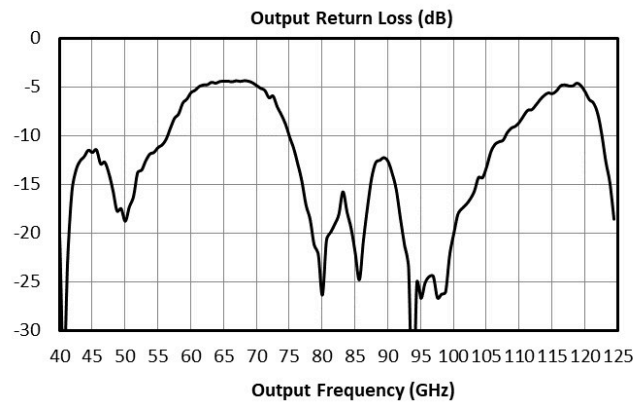
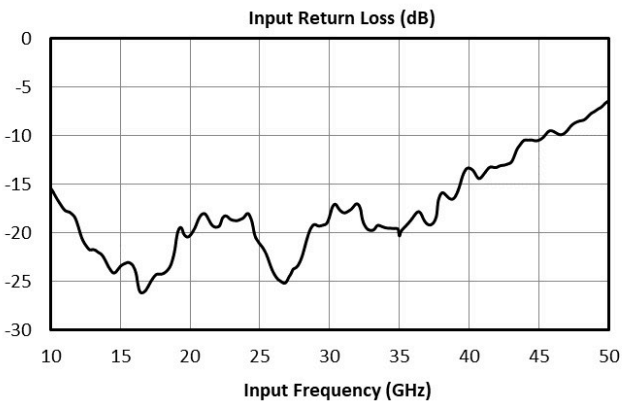
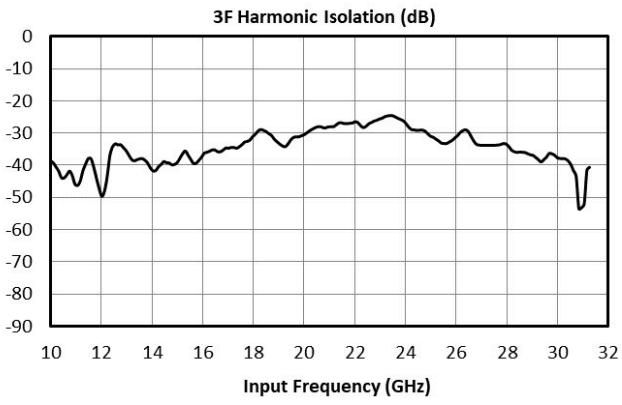
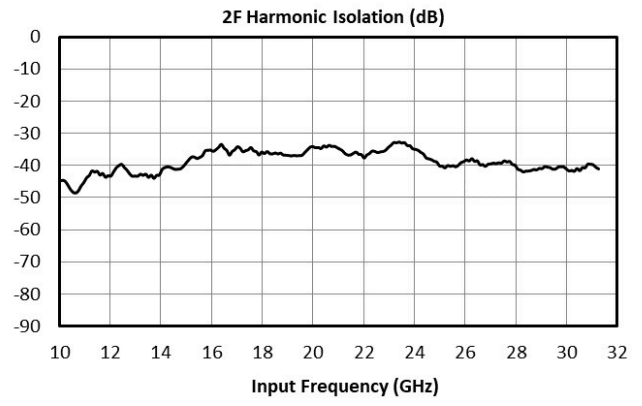
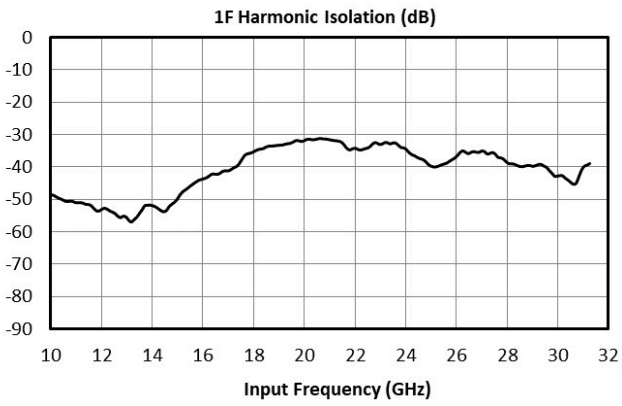

**MMQ-40125HM - Typical Performance Plots**

Performance plots for the connectorized module are shown for measurements where directly probed measurements of the die are unavailable. Note that the following measurements include losses from connectors and microstrip traces.

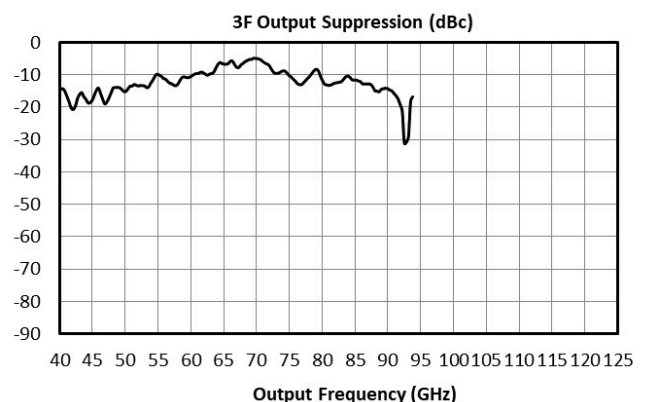
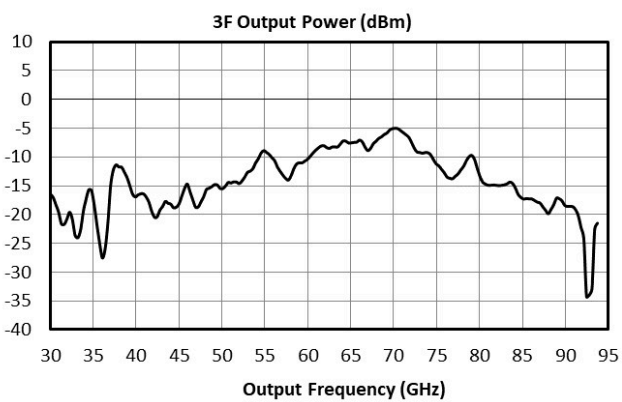
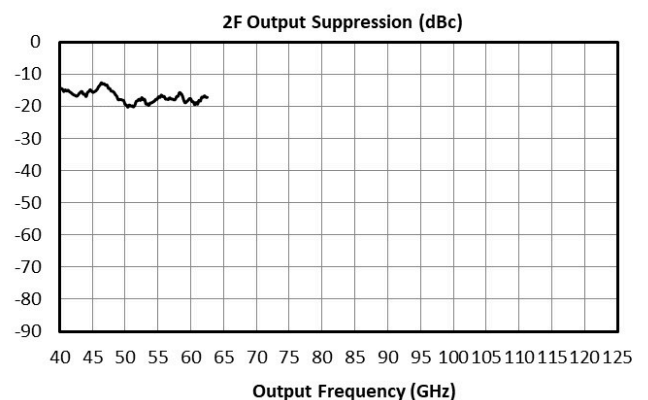
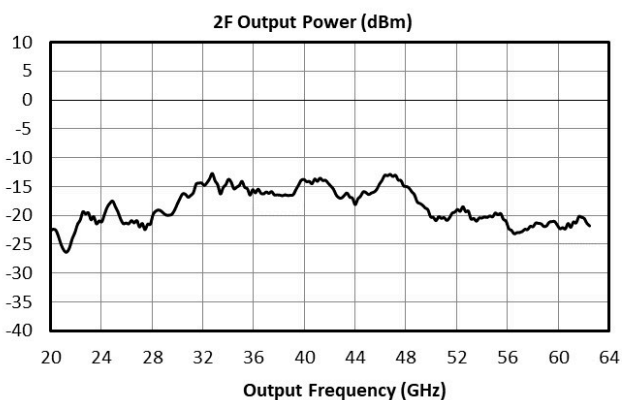
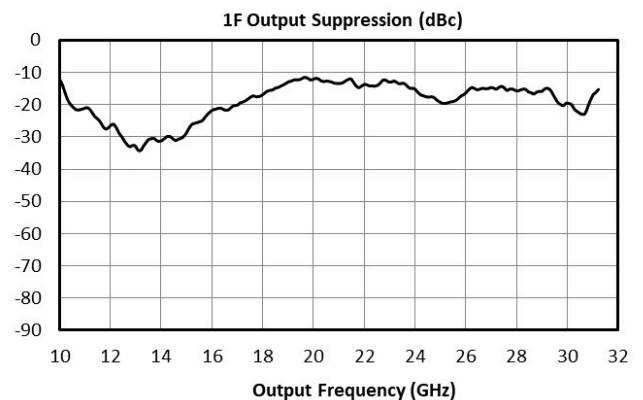
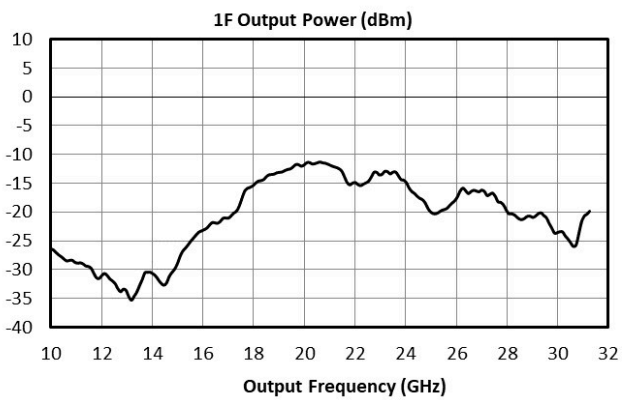
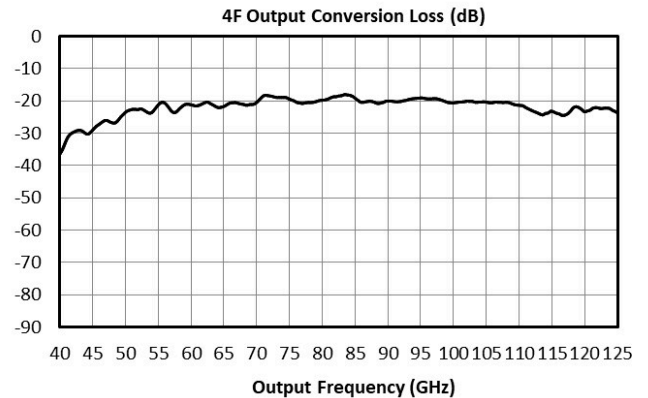
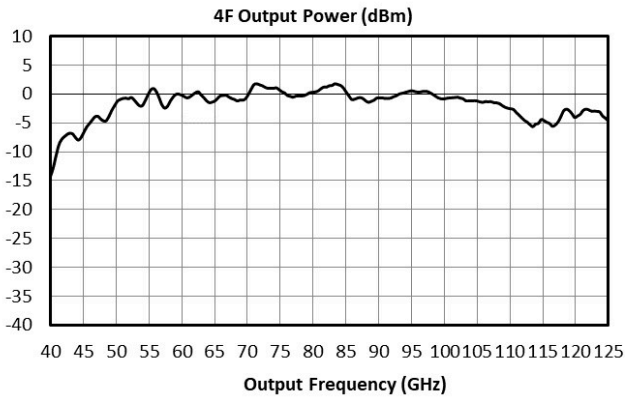

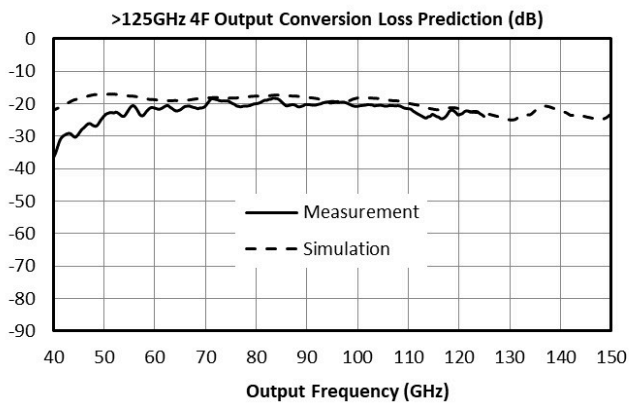
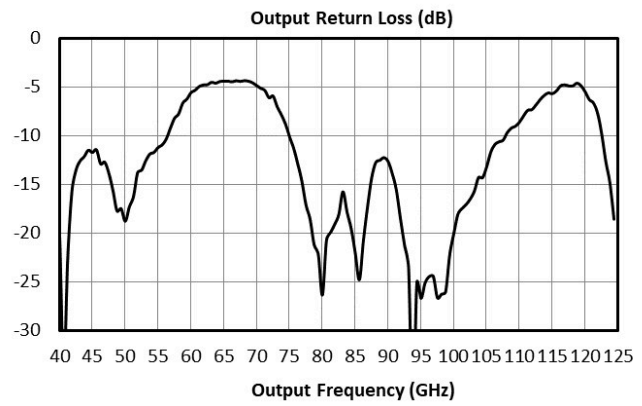
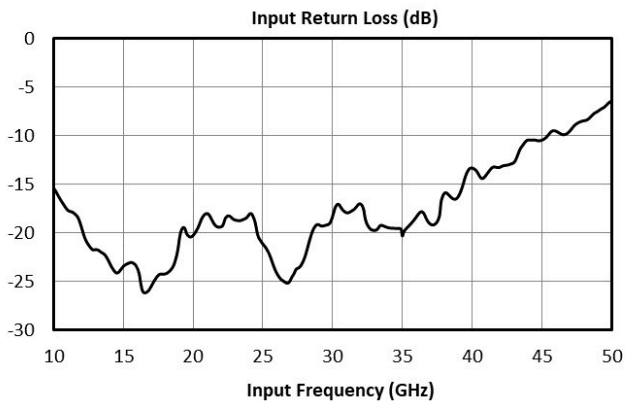
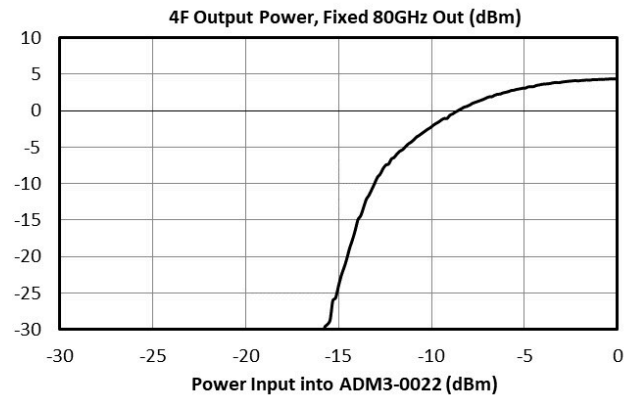
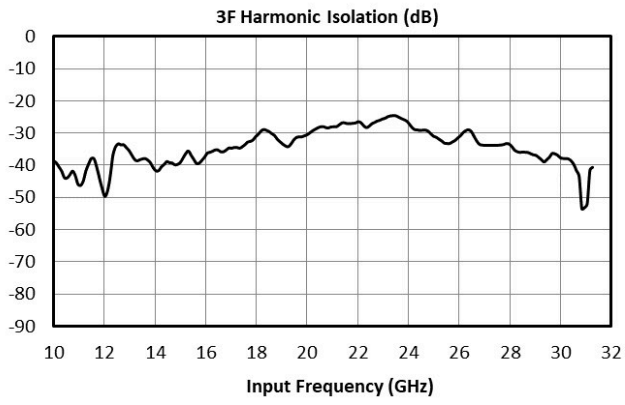
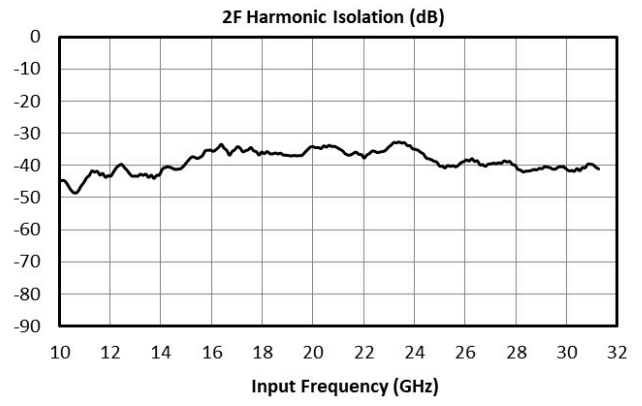
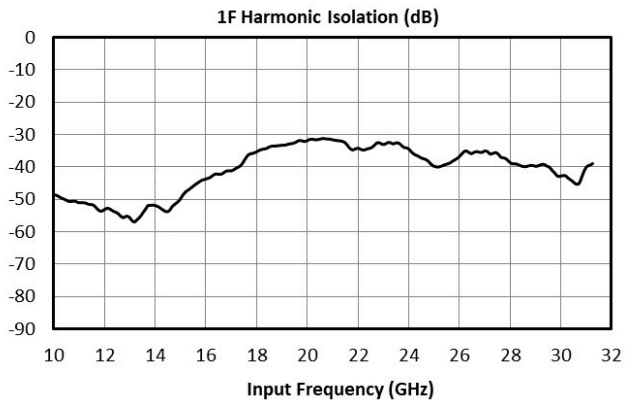

## Die Mounting Recommendations

### Mounting and Bonding Recommendations

Marki MMICs should be attached directly to a ground plane with conductive epoxy. The ground plane electrical impedance should be as low as practically possible. This will prevent resonances and permit the best possible electrical performance. Datasheet performance is only guaranteed in an environment with a low electrical impedance ground.

**Mounting** - To epoxy the chip, apply a minimum amount of conductive epoxy to the mounting surface so that a thin epoxy fillet is observed around the perimeter of the chip. Cure epoxy according to manufacturer instructions.

**Wire Bonding** - Ball or wedge bond with 0.025 mm (1 mil) diameter pure gold wire. Thermosonic wirebonding with a nominal stage temperature of 150 °C and a ball bonding force of 40 to 50 grams or wedge bonding force of 18 to 22 grams is recommended. Use the minimum level of ultrasonic energy to achieve reliable wirebonds. Wirebonds should be started on the chip and terminated on the package or substrate. All bonds should be as short as possible <0.31 mm (12 mils).

**Circuit Considerations** – 50  $\Omega$  transmission lines should be used for all high frequency connections in and out of the chip. Wirebonds should be kept as short as possible, with multiple wirebonds recommended for higher frequency connections to reduce parasitic inductance.

**Bonding Diagram**

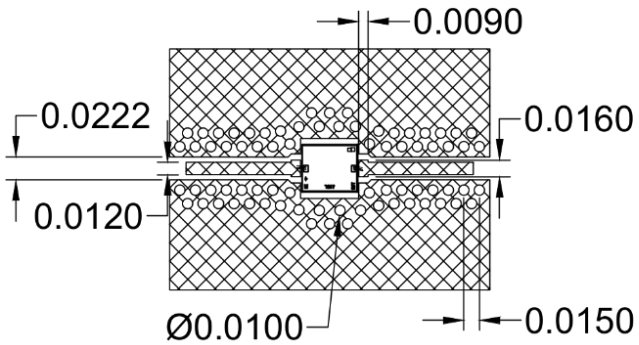

Notes: (Unless otherwise specified)

1. Units in inch
2. Front to back registration to be .002 max.
3. Shaded areas in this drawing are metalized.
4. Substrate is Rogers 5880, 0.005 in thick,  $\frac{1}{2}$  oz Cu
5. Finish: ENIG, 100 $\mu$ -inches of Gold type III Grade A Soft Gold for Wire Bonding over 100-200  $\mu$ -inches solderable Nickel.

## Handling Precautions

### General Handling

Chips should be handled with care using tweezers or a vacuum collet. Users should take precautions to protect chips from direct human contact that can deposit contaminants, like perspiration and skin oils on any of the chip's surfaces.

### Static Sensitivity

GaAs MMIC devices are sensitive to ESD and should be handled, assembled, tested, and transported only in static protected environments.

**Cleaning and Storage:** Do not attempt to clean the chip with a liquid cleaning system or expose the bare chips to liquid. Once the ESD sensitive bags the chips are stored in are opened, chips should be stored in a dry nitrogen atmosphere.

### Mechanical Data

### Outline Drawing

Download : [Outline 2D Drawing](#)

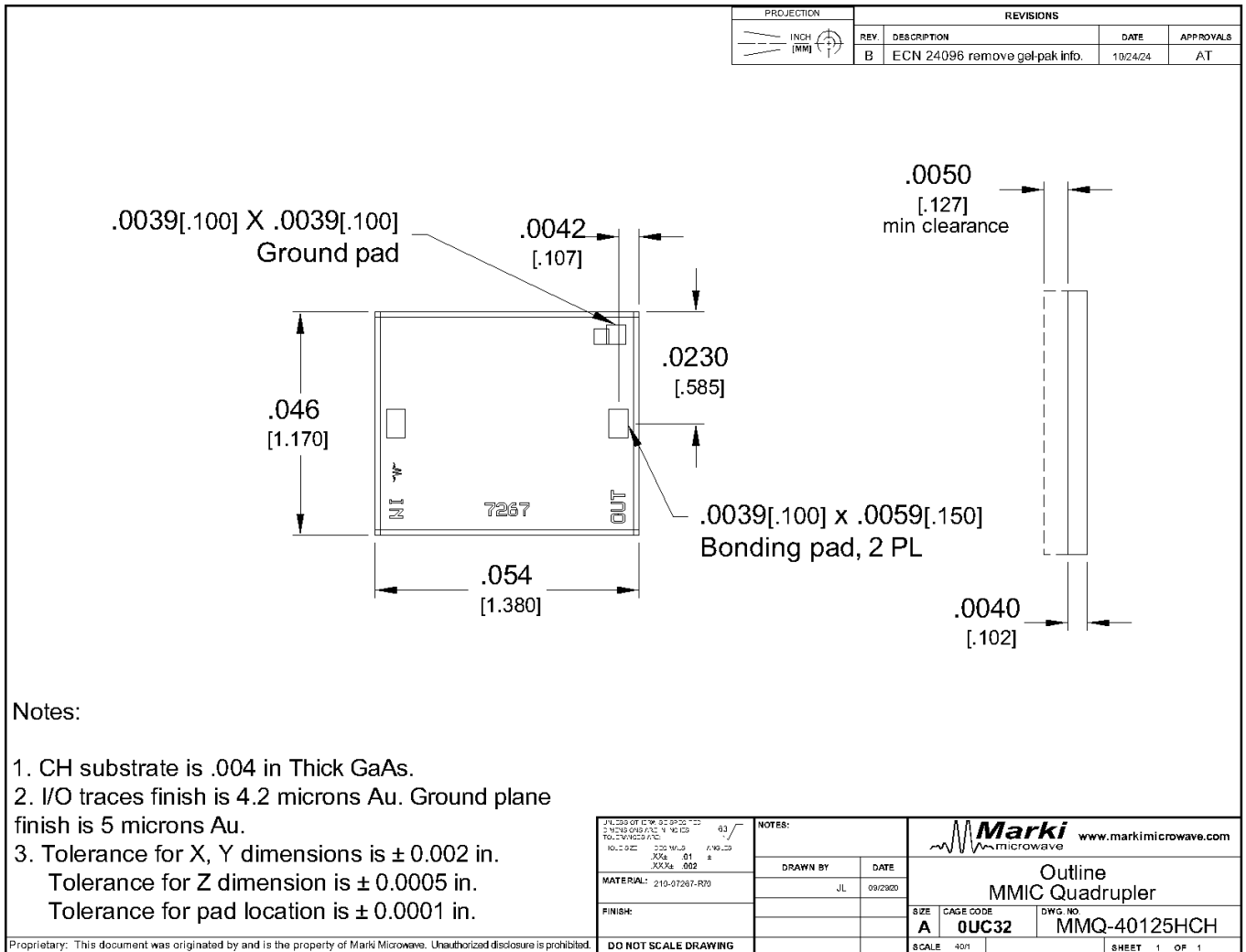

**DISCLAIMER**

MARKI MICROWAVE, LLC., ("MARKI") PROVIDES TECHNICAL SPECIFICATIONS AND DATA (INCLUDING DATASHEETS), APPLICATION OR OTHER DESIGN ADVICE, WEB TOOLS, AND OTHER INFORMATION AND RESOURCES "AS IS" AND WITH ALL FAULTS. MARKI DISCLAIMS ALL WARRANTIES, EXPRESS OR IMPLIED, INCLUDING, WITHOUT LIMITATION, ANY IMPLIED WARRANTIES OF MERCHANTABILITY, FITNESS FOR A PARTICULAR PURPOSE, OR NON-INFRINGEMENT.

These resources are intended for developers skilled in the art designing with Marki products. You are solely responsible for (1) selecting the appropriate products for your application, (2) designing, validating, and testing your application, and (3) ensuring your application meets applicable standards and other requirements. Marki makes no guarantee regarding the suitability of its products for any particular purpose, nor does Marki assume any liability whatsoever arising out of your use or application of any Marki product.

Marki grants you permission to use these resources only for development of an application that uses Marki products. Other reproduction or use of these resources is strictly prohibited. No license is granted to any other Marki intellectual property or to any third-party intellectual property. Marki reserves the right to make changes to the product(s) or information contained herein without notice.

MARKI MICROWAVE and T3 MIXER are trademarks or registered trademarks of Marki Microwave, LLC. All other trademarks used are the property of their respective owners.

© 2020 - 2021, 2024, Marki Microwave, LLC