

BALH-0006SMG

HIGH POWER SURFACE-MOUNT BALUN

DEVICE OVERVIEW

General Description

The BALH-0006SMG is a broadband surface mount balun, hand-tuned for optimal phase and amplitude balance over a 500 kHz to 6 GHz bandwidth. It serves as an excellent choice for analog to digital converters, balanced receivers, baseband digital modulations, and signal integrity enhancement.

[Download s-parameters here](#)

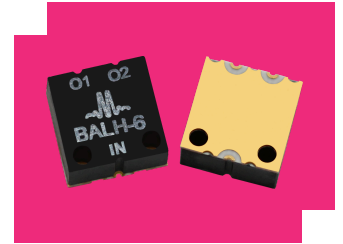

Features

- 1:1 Impedance Ratio
- 500 kHz to 6 GHz Balun (Balanced to Unbalanced Transformer)
- High 37 dBm 1-dB compression enables high power applications
- Tuned for Optimal Phase/Amplitude Balance

Applications

- Balanced Amplifiers
- Baseband Digital Modulation
- Signal Integrity

Functional Block Diagram

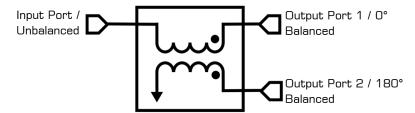

Part Ordering Options

Part Number	Description	Package	Green Status	Product Lifecycle	Export Classification
BALH-0006SMG	HIGH POWER SURFACE-MOUNT BALUN	SMG	REACH RoHS	Released	EAR99
EVAL-BALH-0006	Evaluation Board, High Power Surface-Mount Balun	EVAL	Consult Factory	Released	EAR99

Table Of Contents

- **Device Overview**
 - General Description
 - Features
 - Applications
 - Functional Block Diagram
- **Port Configuration and Functions**
 - Port Diagram
- **Revision History**
- **Specifications**
 - Absolute Maximum Ratings
 - Package Information
 - Electrical Specifications
 - Mixed Mode Scattering Parameters
 - Typical Performance Scattering Parameters
- **Mechanical Data**
 - Outline Drawing
- **Footprint Image**
- **Evaluation Board**
 - Evaluation Board - Performance Data
 - Evaluation Board Outline Drawing

Revision History

Revision Code	Revision Date	Comment
-	2013-02-01	Datasheet initial Release
A	2019-03-01	Evaluation board outline added
B	2019-10-01	Mixed Mode Scattering Parameters added
C	2020-04-01	Unit Spread Graphs Added
D	2020-07-01	Specs table update
E	2020-10-01	Specs table update
F	2022-05-01	Max DC current update, Ground Plane Finish Update
G	2022-11-01	Banded Electrical Specifications Added
H	2024-03-06	Updated specs table to add frequency resolution to insertion loss, balance and rejection specs.

Specifications

Absolute Maximum Ratings

Parameter	Maximum Rating	Unit
DC Current	1	A
Maximum Operating Temperature	100	°C
Maximum Storage Temperature	125	°C
Minimum Operating Temperature	-55	°C
Minimum Storage Temperature	-65	°C
RF Power Handling	33	dBm

Package Information

Parameter	Details	Rating
Weight	Package name: SMG	0.24g
Dimensions	-	8.13 x 8.13 mm
Moisture Sensitivity Level	-	MSL 1

Electrical Specifications

The electrical specifications apply at TA=+25°C in a 50Ω system. Min and Max limits are guaranteed at TA=+25°C.

Parameter	Test Conditions	Minimum Frequency (GHz)	Maximum Frequency (GHz)	Min	Typ	Max	Unit
VSWR (Input)	-	0.0005	6	-	1.6	-	
VSWR (Input)	-	3	6	-	2.1	-	
VSWR (Output)	-	0.0005	6	-	1.1	-	
VSWR (Output)	-	3	6	-	1.2	-	
Isolation	-	3	6	-	6	-	dB
Input P1dB	-	0.0005	6	-	37	-	dBm
Impedance Ratio	-	-	-	-	1:1	-	
Risetime/Falltime ¹	-	0.0005	6	-	22	-	ps
Nominal Phase Shift	-	0.0005	-	-	180	-	°
Amplitude Balance	-	0.0005	0.002	-	0.5	-	dB
Amplitude Balance	-	0.002	0.01	-	0.2	3.5	dB
Amplitude Balance	-	0.01	6	-	0.2	1.2	dB
Phase Balance	-	0.0005	0.002	-	2.5	-	°
Phase Balance	-	0.002	0.01	-	2	14	°
Phase Balance	-	0.01	6	-	3	10	°
Common Mode Rejection	-	0.0005	0.002	-	30	-	dB
Common Mode Rejection	-	0.002	0.01	13	32	-	dB
Common Mode Rejection	-	0.01	6	17	30	-	dB
Insertion Loss as a Mode Converter	-	0.0005	0.002	-	2	-	dB
Insertion Loss as a Mode Converter	-	0.002	0.01	-	1.9	4	dB
Insertion Loss as a Mode Converter	-	0.01	6	-	2	3.5	dB

^[1] Specified as 90%/10%.

Mixed Mode Scattering Parameters

Mixed mode scattering parameters are used to characterize differential circuits. For baluns, this means that the 0° and 180° ports become a single 100Ω differential port and the common port remains the same 50Ω common port. The two-port s-parameters of the balun are then characterized based on differential (d), common mode (c), or single-ended (s) signals. For example: Sds12 is the differential output response given a single ended input.

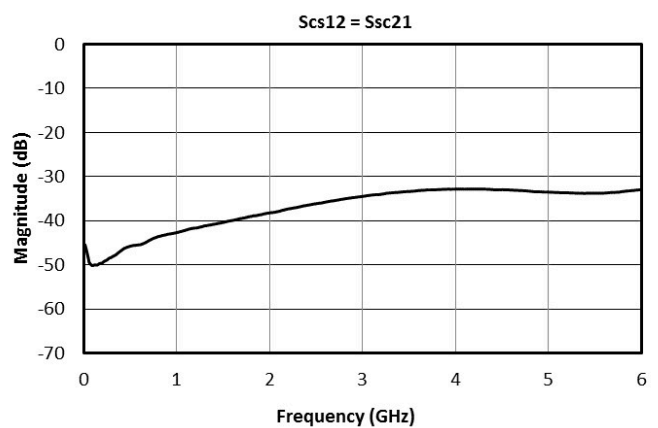
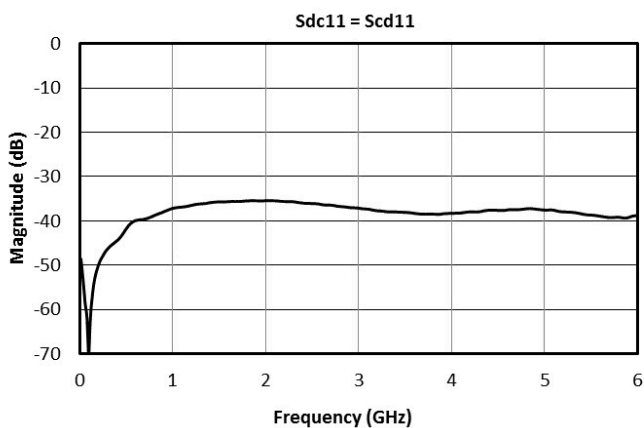
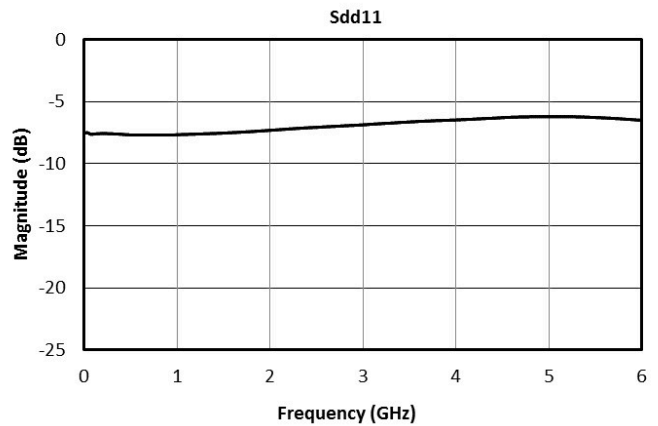
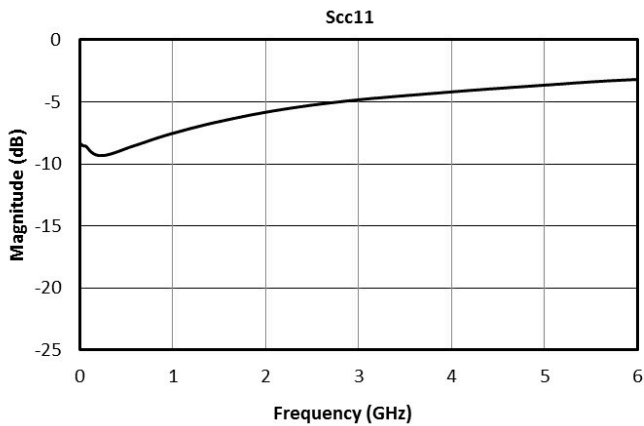
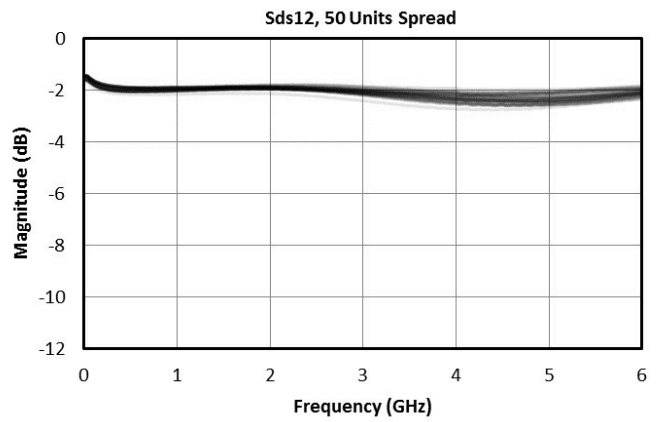
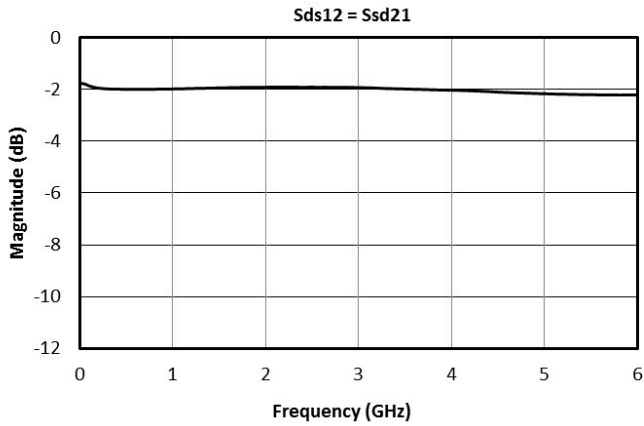

BALH-0006SMG

HIGH POWER SURFACE-MOUNT BALUN

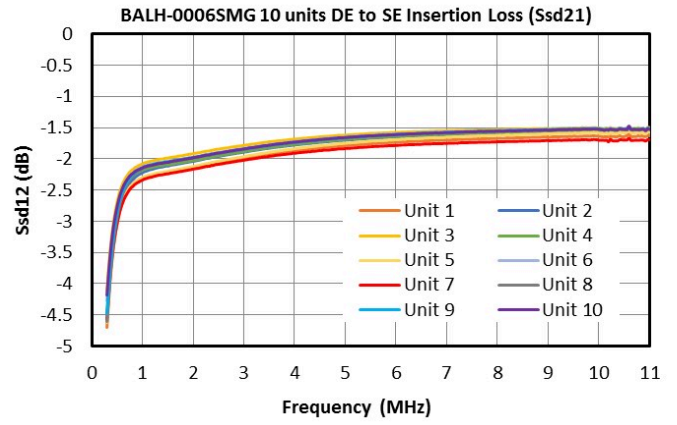
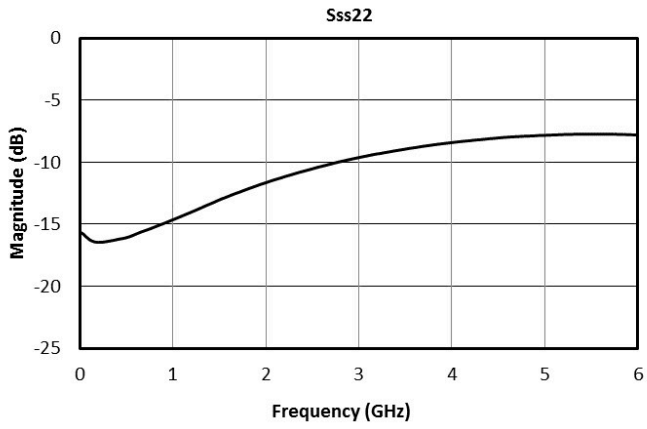

Typical Performance Scattering Parameters

Three port scattering parameters measured as three single-ended 50Ω ports showing relationship between any two ports. For example: S21 and S31, often referred to as insertion loss of a balun, is the output response on ports 2 and 3 with an input stimulus on port 1.

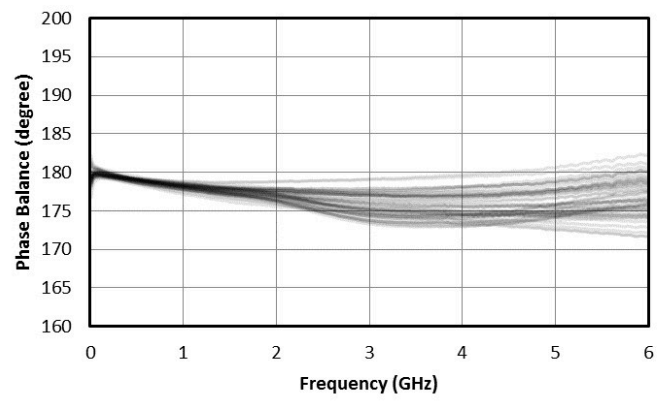
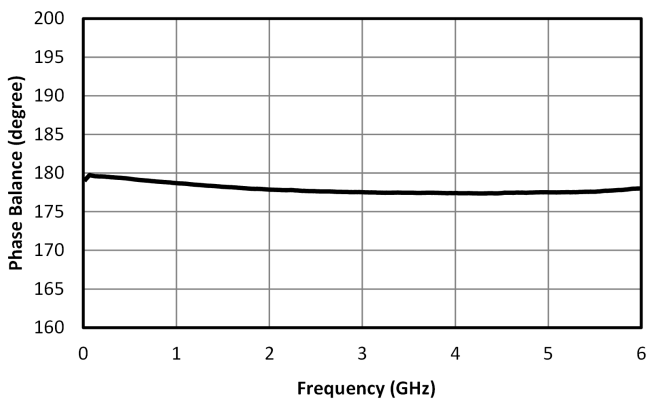
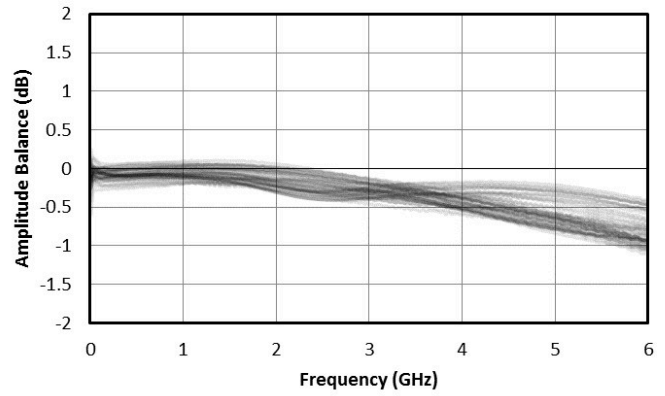
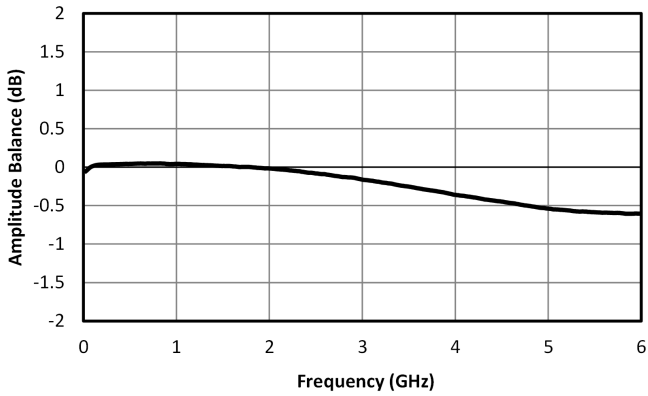
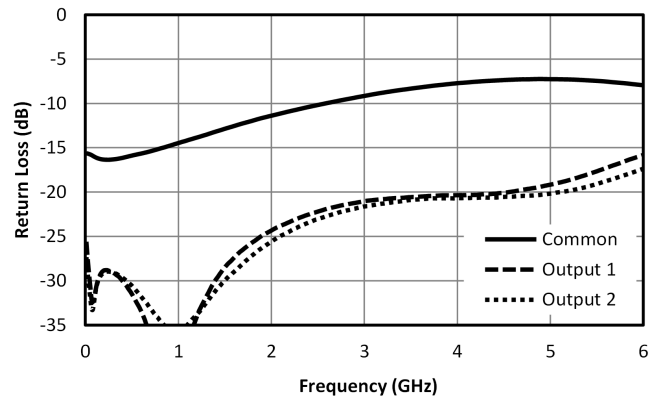
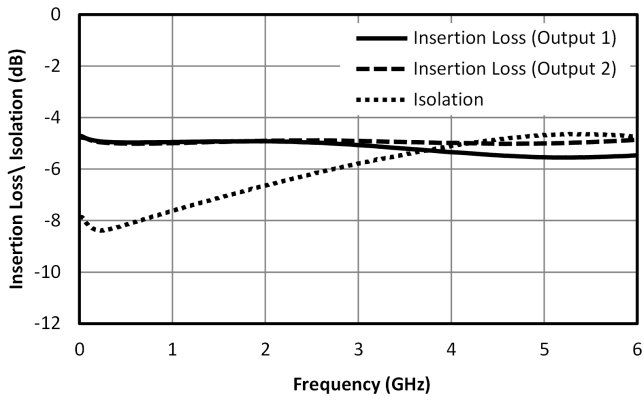

BALH-0006SMG HIGH POWER SURFACE-MOUNT BALUN

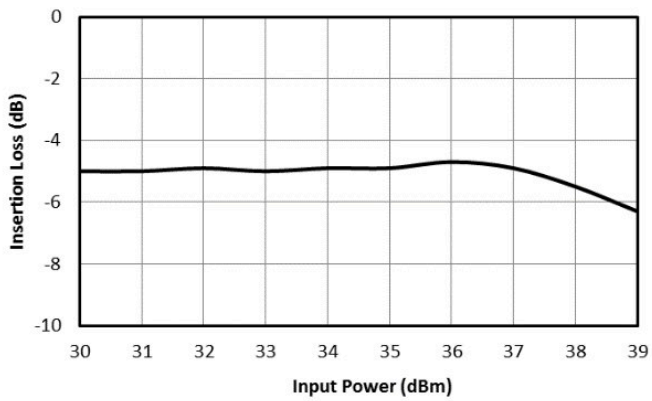
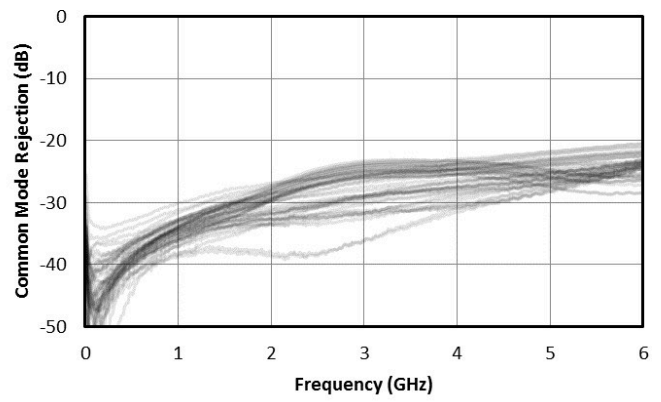
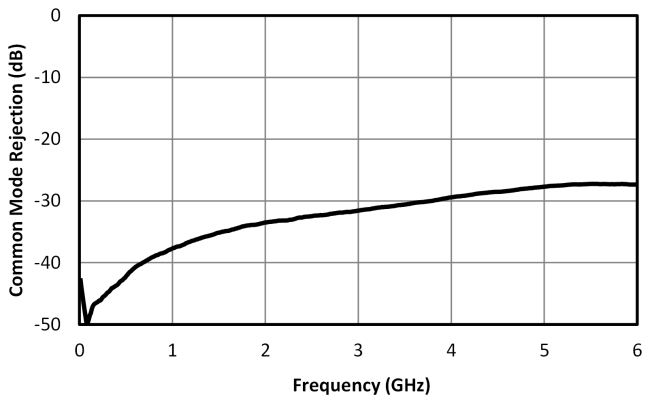

Mechanical Data

Outline Drawing

Download : [Outline 2D Drawing](#) | [Outline 3D Drawing](#) | [Outline 3D STP](#)

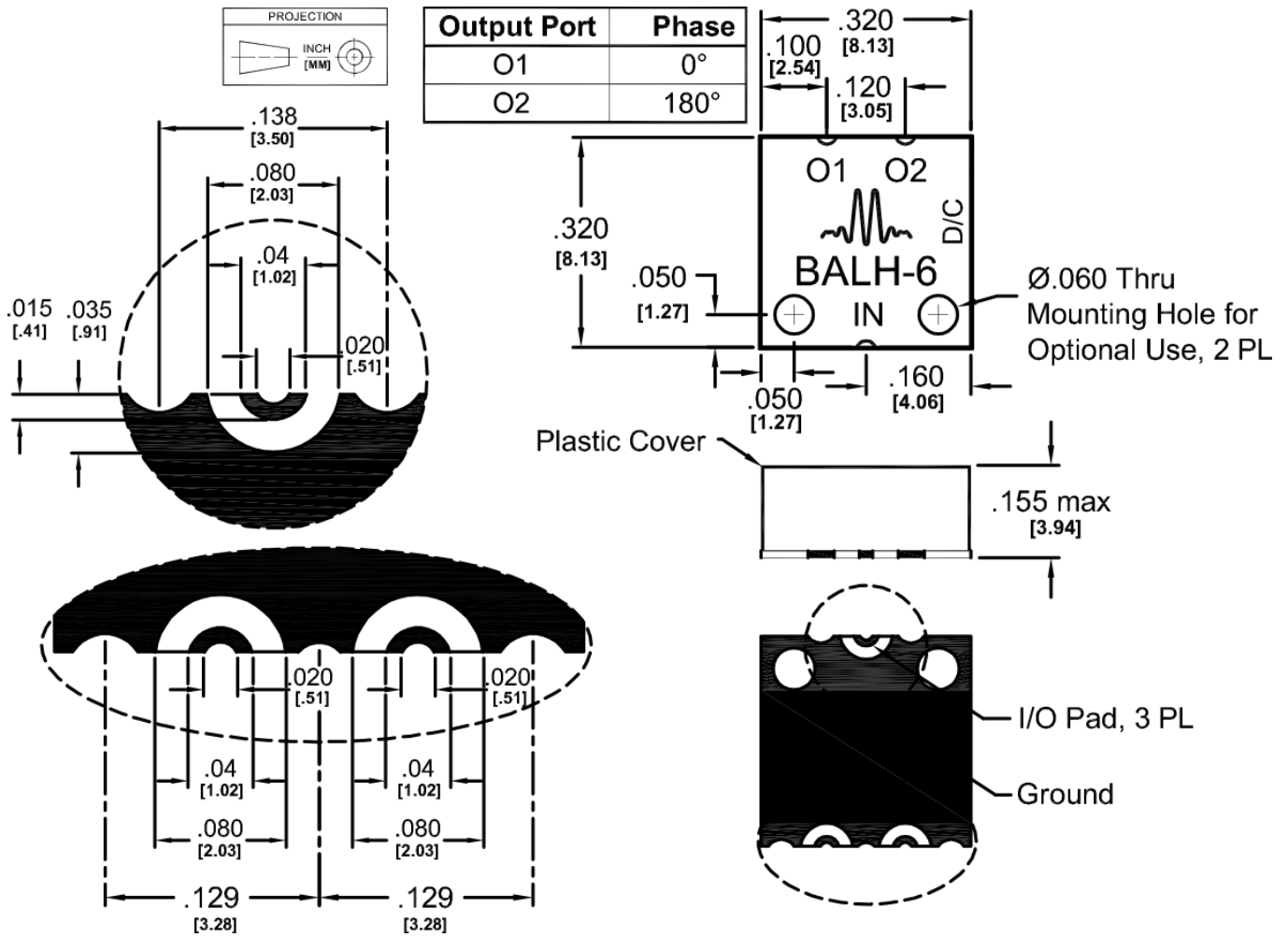

Substrate material is 8-mil thick Rogers 4003, 1 Oz Electrodeposited Cu. I/O Pads & Ground Plane Finish is Gold Flash, 5 to 10 microns, over Electroplated Nickel, 100-200 microns, over Cu.

Footprint Image

Download : [Footprint Drawing](#)

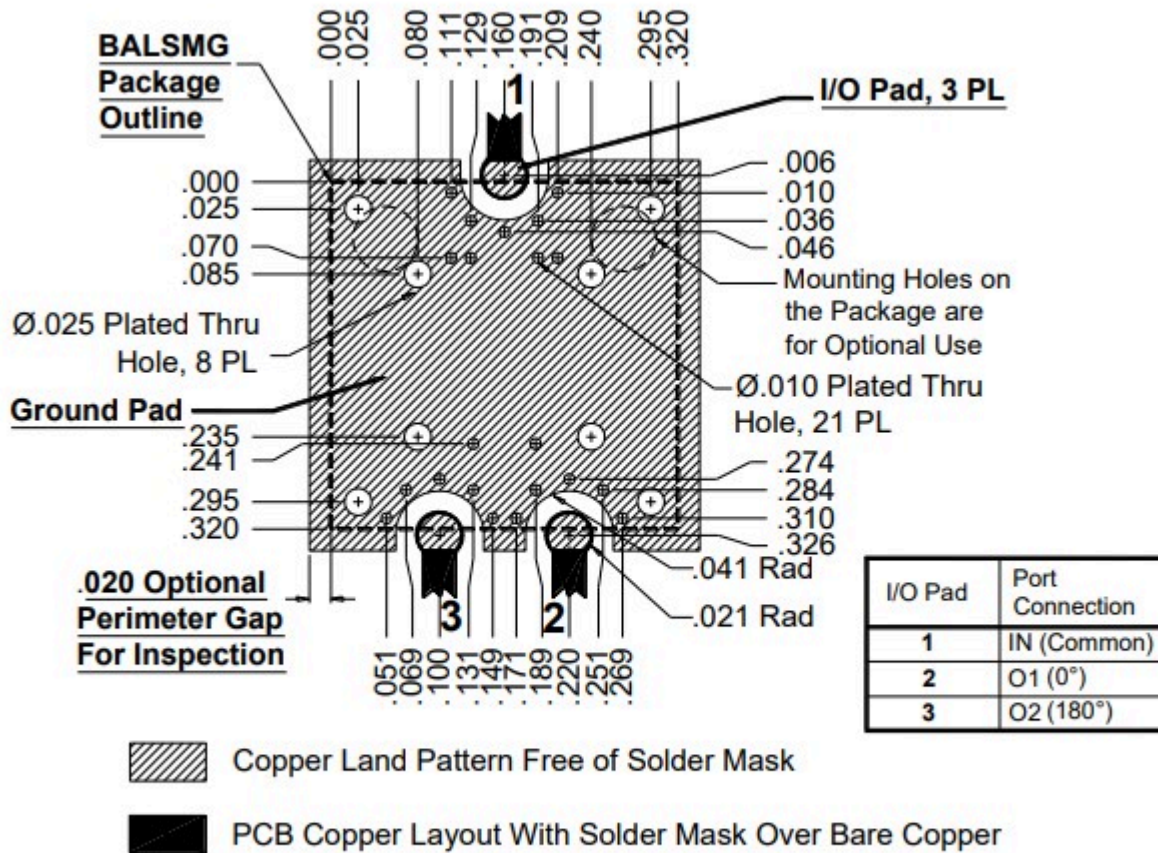

Note: Trace widths shown are for Rogers RO5880/Taconic TLY-5, .010" thick, ½ Oz copper. Widths may need to be modified for other materials.

Evaluation Board - Performance Data

Parameter	Test Conditions	Frequency Range (GHz)	Min	Typ	Max	Unit
Impedance Ratio	-	-	-	1	-	

Evaluation Board - Outline Drawing

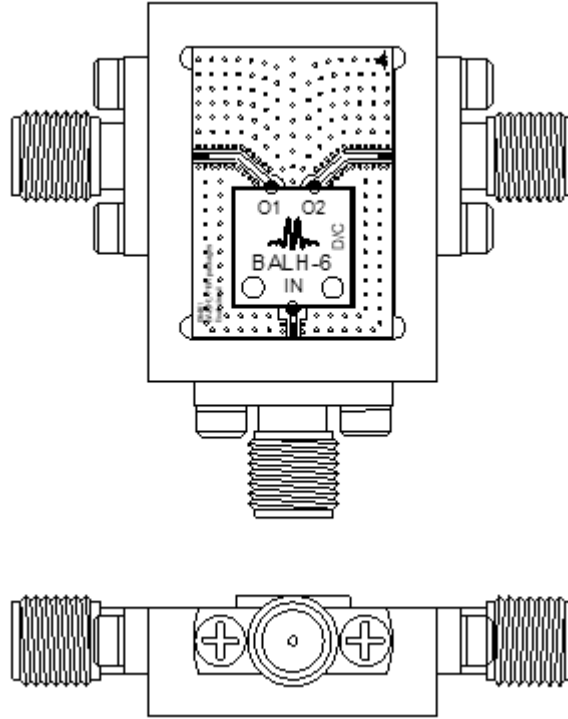

DISCLAIMER

MARKI MICROWAVE, LLC., ("MARKI") PROVIDES TECHNICAL SPECIFICATIONS AND DATA (INCLUDING DATASHEETS), APPLICATION OR OTHER DESIGN ADVICE, WEB TOOLS, AND OTHER INFORMATION AND RESOURCES "AS IS" AND WITH ALL FAULTS. MARKI DISCLAIMS ALL WARRANTIES, EXPRESS OR IMPLIED, INCLUDING, WITHOUT LIMITATION, ANY IMPLIED WARRANTIES OF MERCHANTABILITY, FITNESS FOR A PARTICULAR PURPOSE, OR NON-INFRINGEMENT.

These resources are intended for developers skilled in the art designing with Marki products. You are solely responsible for (1) selecting the appropriate products for your application, (2) designing, validating, and testing your application, and (3) ensuring your application meets applicable standards and other requirements. Marki makes no guarantee regarding the suitability of its products for any particular purpose, nor does Marki assume any liability whatsoever arising out of your use or application of any Marki product.

Marki grants you permission to use these resources only for development of an application that uses Marki products. Other reproduction or use of these resources is strictly prohibited. No license is granted to any other Marki intellectual property or to any third-party intellectual property. Marki reserves the right to make changes to the product(s) or information contained herein without notice.

MARKI MICROWAVE and T3 MIXER are trademarks or registered trademarks of Marki Microwave, LLC. All other trademarks used are the property of their respective owners.

© 2013, 2019 - 2020, 2022, 2024, Marki Microwave, LLC