

# MFHP-00006PSM

## Passive GaAs MMIC 12 GHz Highpass Filter

### DEVICE OVERVIEW

#### General Description

The MFHP-00006PSM family of passive MMIC surface mount highpass filters are an ideal solution for small form factor, high rejection filtering. Passive GaAs MMIC technology allows production of smaller filter constructions that replace larger form factor circuit board constructions. Tight fabrication tolerances allow for less unit-to-unit variation than traditional filter technologies. The MFHP-00006PSM is available as a 4x4mm plastic QFN. Low unit to unit variation allows for accurate simulations using the provided S2P file taken from measured production units.

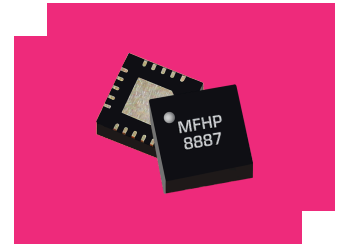

[Download s-parameters here](#)

#### Features

- Low Passband Insertion Loss with Fast Roll-off
- Excellent Return Loss
- High Stop Band Suppression

#### Applications

- SATCOM
- Radar

#### Functional Block Diagram

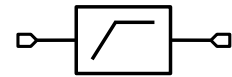

#### Part Ordering Options

Part Number	Description	Package	Green Status	Product Lifecycle	Export Classification
MFHP-00006PSM	Passive GaAs MMIC 12 GHz Highpass Filter	QFN	RoHS REACH	Released	EAR99
EVB-MFHP-00006P	Evaluation Board, Passive GaAs MMIC 12GHz Highpass Filter	EVB	RoHS REACH	Released	EAR99

## Table Of Contents

- **Device Overview**
  - General Description
  - Features
  - Applications
  - Functional Block Diagram
- **Port Configuration and Functions**
  - Port Diagram
  - Port Functions
- **Revision History**
- **Specifications**
  - Absolute Maximum Ratings
  - Package Information
  - Electrical Specifications
  - Typical Performance Plots
- **Mechanical Data**
  - Outline Drawing
- **Footprint Image**
- **Evaluation Board**
  - Evaluation Board Outline Drawing

## Revision History

Revision Code	Revision Date	Comment
-	2023-10-04	Datasheet Initial Release

## Port Configuration and Functions

### Port Diagram

A top-down x-ray view of the MFHP-00006PSM package outline drawing is shown below.

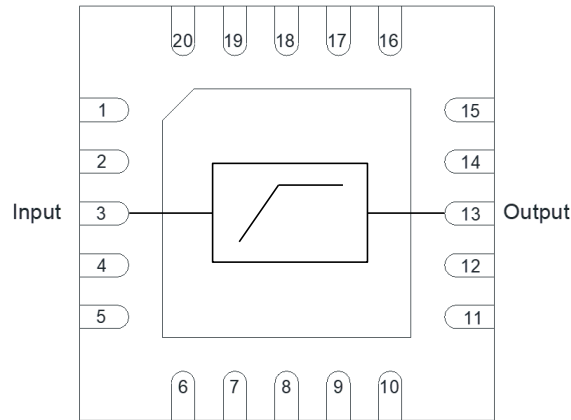

### Port Functions

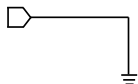
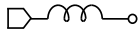
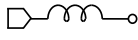
Port	Function	Description	Equivalent Circuit for Package
Ground Paddle	Ground	PSM package ground path is provided through the ground paddle and should be connected to RF ground.	
Pin 13	Output	Pin 13 is DC open to ground for the PSM package.	
Pin 3	Input	Pin 3 is DC open to ground for the PSM package.	

## Specifications

### Absolute Maximum Ratings

The Absolute Maximum Ratings indicate limits beyond which damage may occur to the device. If these limits are exceeded, the device may be inoperable or have a reduced lifetime.

Parameter	Maximum Rating	Unit
Maximum Operating Temperature	100	°C
Maximum Storage Temperature	125	°C
Minimum Operating Temperature	-55	°C
Minimum Storage Temperature	-65	°C

### Package Information

Parameter	Details	Rating
Dimensions	-	4 x 4 mm
Moisture Sensitivity Level	-	MSL 1

### Electrical Specifications

The electrical specifications apply at TA=+25°C in a 50Ω system. Typical data shown is for the filter in a PSM package with a sine wave input applied to Pin 3. Min and Max limits are guaranteed at TA=+25°C.

Parameter	Test Conditions	Minimum Frequency (GHz)	Maximum Frequency (GHz)	Min	Typ	Max	Unit
1 dBc Passband	Configuration A, Temp = 25°C	12.06	12	-	-	-	GHz
3 dBc Passband	Configuration A, Temp = 25°C	11.44	12	-	-	-	GHz
30 dBc Rejection Point	Configuration A, Temp = 25°C	10.04	10.04	-	-	-	GHz
3dBc Cutoff Frequency	-	-	-	-	12	-	GHz
Group Delay	-	13.5	35	-	48	-	ps
Passband Insertion Loss	-	13.5	35	-	0.5	-	dB
Passband Return Loss	-	13.5	35	10	21	-	dB
Stopband Suppression	-	0	8.3	40	55	-	dB

Typical performance is de-embedded from EVB using AFR.

### Typical Performance Plots

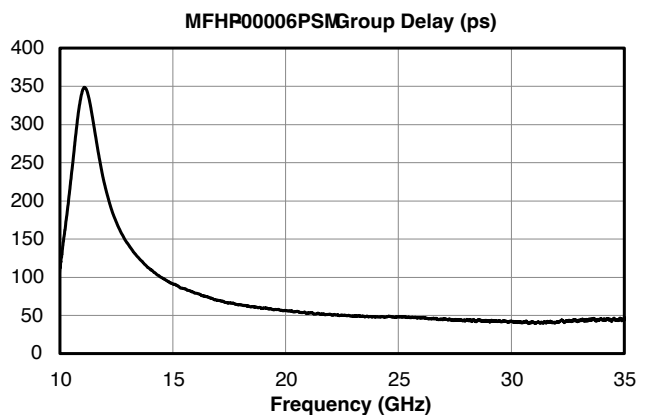
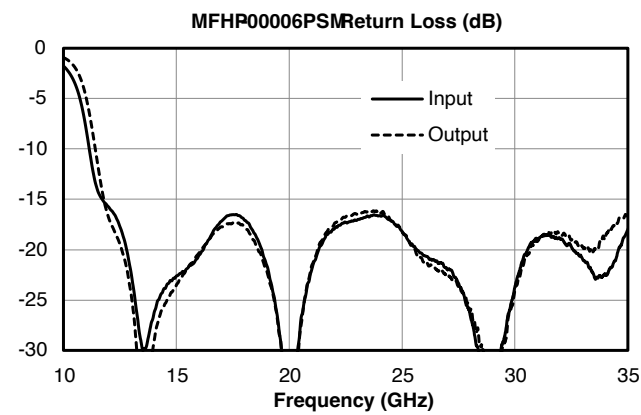
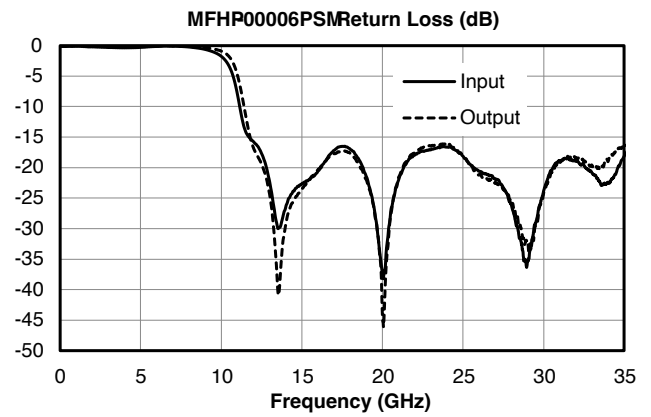
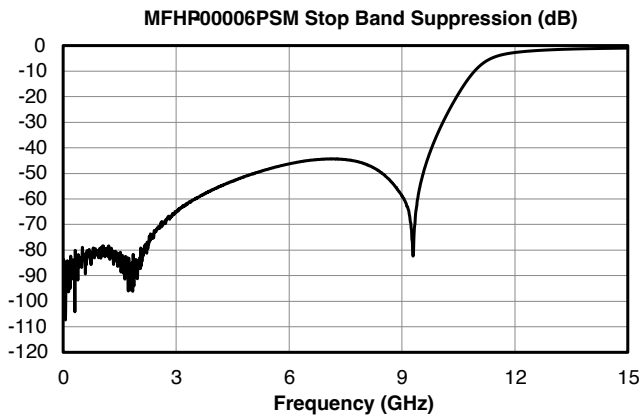
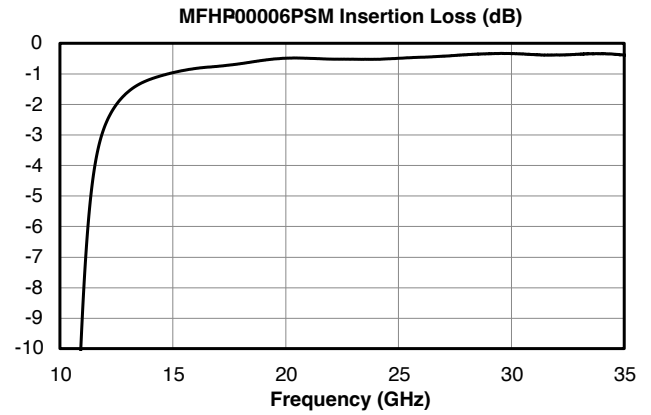
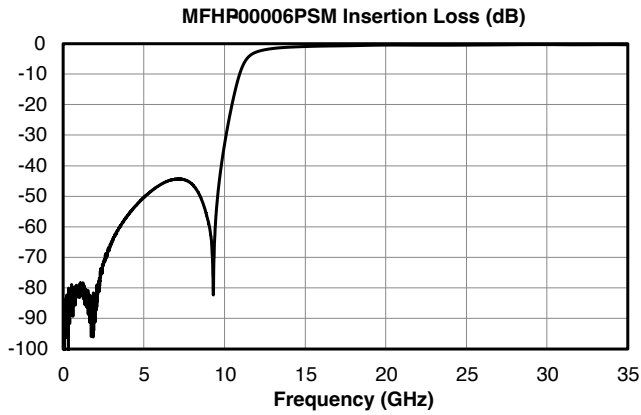



### Footprint Image

Download : [Footprint Drawing](#)

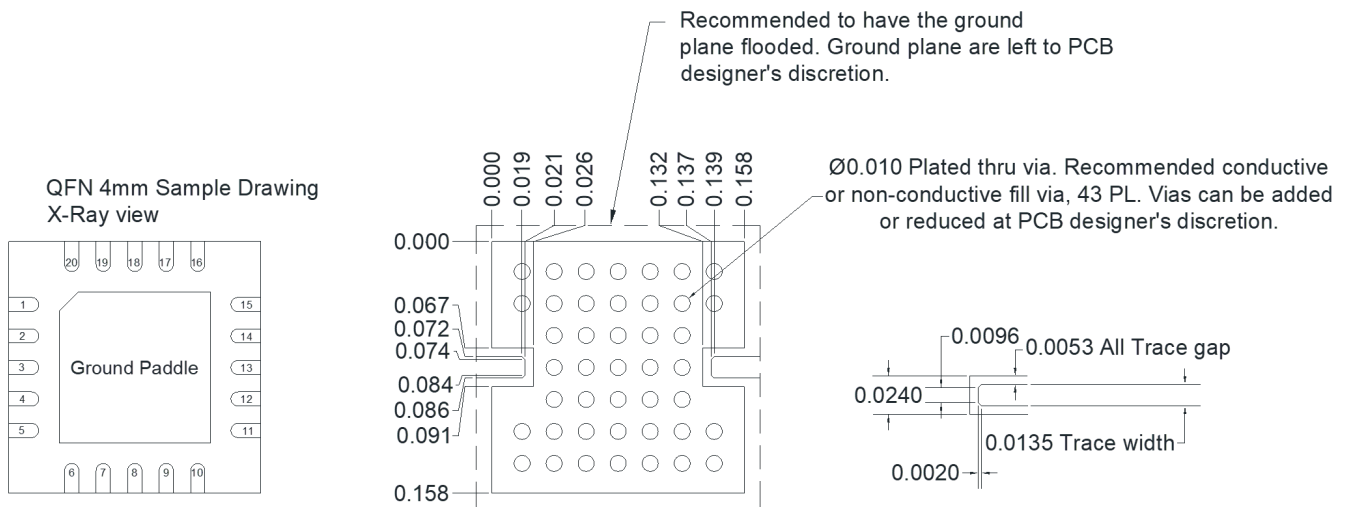

The Landing Pattern is to be used on Rogers 4003,  
0.008" thick  $\frac{1}{2}$  Oz Cu.

**Evaluation Board - Outline Drawing**

All measurements are typical

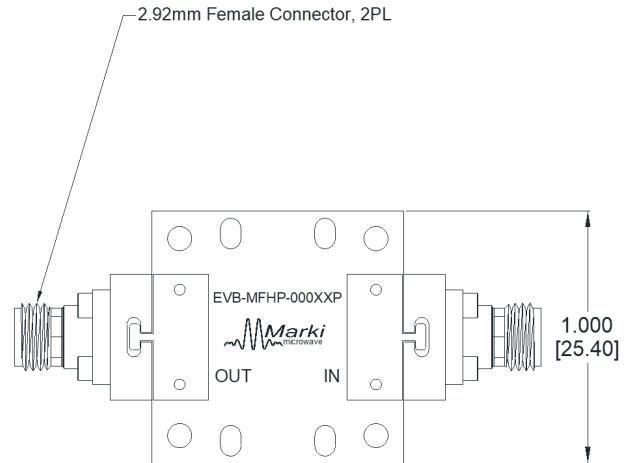
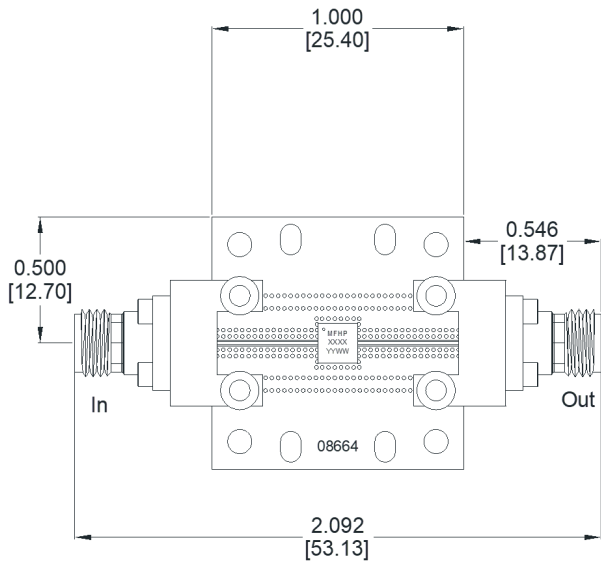
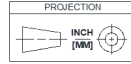

**DISCLAIMER**

MARKI MICROWAVE, INC., ("MARKI") PROVIDES TECHNICAL SPECIFICATIONS AND DATA (INCLUDING DATASHEETS), APPLICATION OR OTHER DESIGN ADVICE, WEB TOOLS, AND OTHER INFORMATION AND RESOURCES "AS IS" AND WITH ALL FAULTS. MARKI DISCLAIMS ALL WARRANTIES, EXPRESS OR IMPLIED, INCLUDING, WITHOUT LIMITATION, ANY IMPLIED WARRANTIES OF MERCHANTABILITY, FITNESS FOR A PARTICULAR PURPOSE, OR NON-INFRINGEMENT. These resources are intended for developers skilled in the art designing with Marki products. You are solely responsible for (1) selecting the appropriate products for your application, (2) designing, validating, and testing your application, and (3) ensuring your application meets applicable standards and other requirements. Marki makes no guarantee regarding the suitability of its products for any particular purpose, nor does Marki assume any liability whatsoever arising out of your use or application of any Marki product.

Marki grants you permission to use these resources only for development of an application that uses Marki products. Other reproduction or use of these resources is strictly prohibited. No license is granted to any other Marki intellectual property or to any third-party intellectual property. Marki reserves the right to make changes to the product(s) or information contained herein without notice.

MARKI MICROWAVE and T3 MIXER are trademarks or registered trademarks of Marki Microwave, Inc. All other trademarks used are the property of their respective owners.

© 2023, Marki Microwave, Inc