

EVAL-MEQ3-20A

Evaluation Board, Passive GaAs MMIC 20 GHz Equalizer

DEVICE OVERVIEW

General Description

The EVAL-MEQ3-20A is a connectorized evaluation board for the MEQ3-20ASM passive MMIC surface mount 20 GHz Equalizer.

[Download s-parameters here](#)

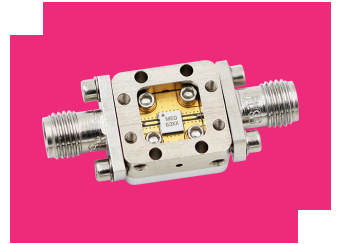

Features

N/A

Applications

N/A

Functional Block Diagram



Part Ordering Options

Part Number	Description	Package	Green Status	Product Lifecycle	Export Classification
MEQ3-20ASM	Passive GaAs MMIC 20 GHz Equalizer	QFN	REACH RoHS	Released	EAR99
EVAL-MEQ3-20A	Evaluation Board, Passive GaAs MMIC 20 GHz Equalizer	EVAL	REACH RoHS	Released	EAR99



www.markimicrowave.com

EVAL-MEQ3-20A

Evaluation Board, Passive GaAs MMIC 20 GHz Equalizer

Table Of Contents

- **Device Overview**

- General Description
- Features
- Applications
- Functional Block Diagram

- **Specifications**

- **Mechanical Data**

- Outline Drawing

- **Evaluation Board**

- Evaluation Board Outline Drawing

EVAL-MEQ3-20A

Evaluation Board, Passive GaAs MMIC 20 GHz Equalizer

Mechanical Data

Outline Drawing

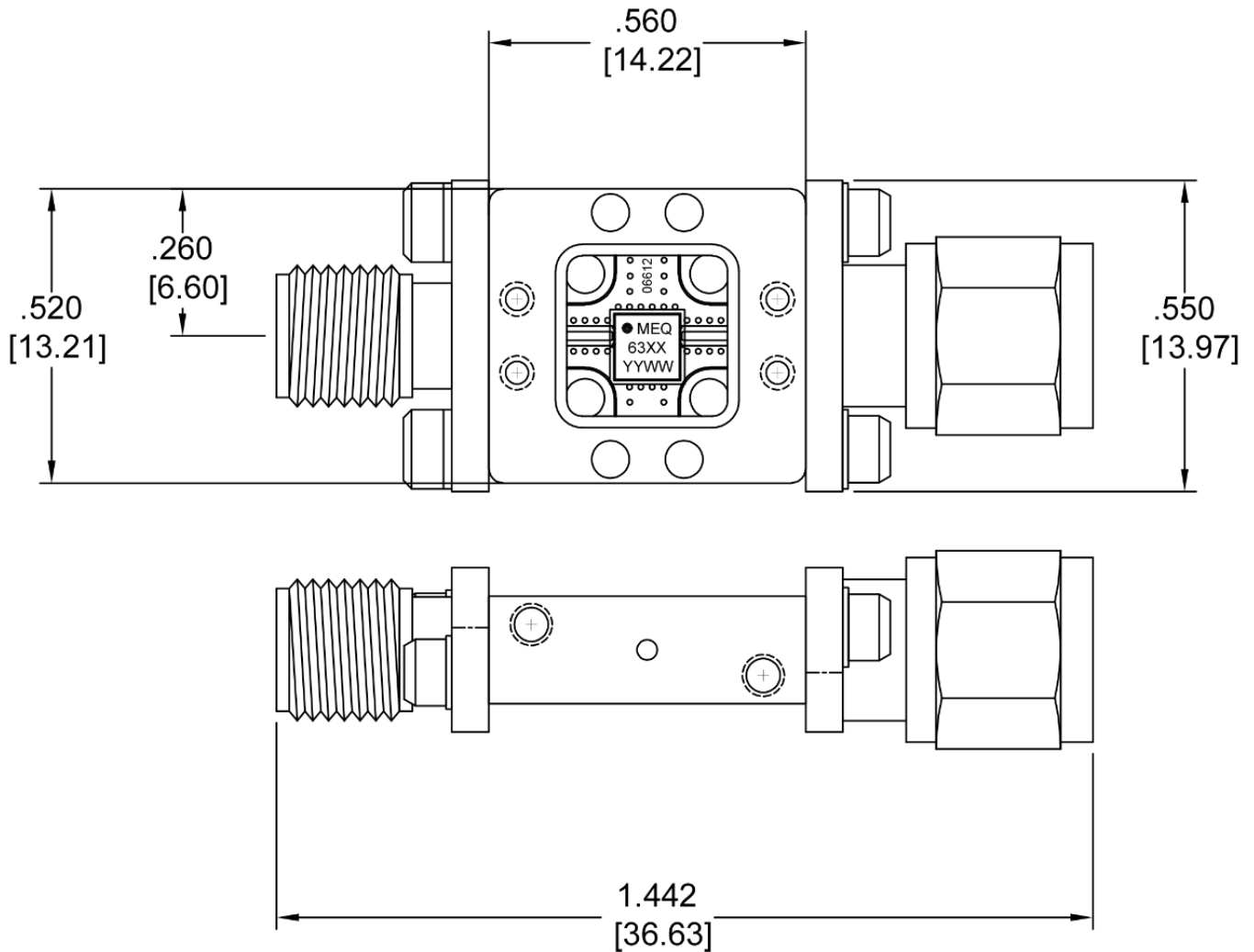

XX	Part Number
39	Eval-MEQ3-20A
40	Eval-MEQ6-20A
41	Eval-MEQ10-20A
42	Eval-MEQ5-20A
43	Eval-MEQ7-20A
45	Eval-MEQ11-20A

Port	Connector Type
I	SMA Female
O	SMA Male

Note: Eval-Package Connectors are not removeable.

EVAL-MEQ3-20A

Evaluation Board, Passive GaAs MMIC 20 GHz Equalizer

Evaluation Board - Outline Drawing

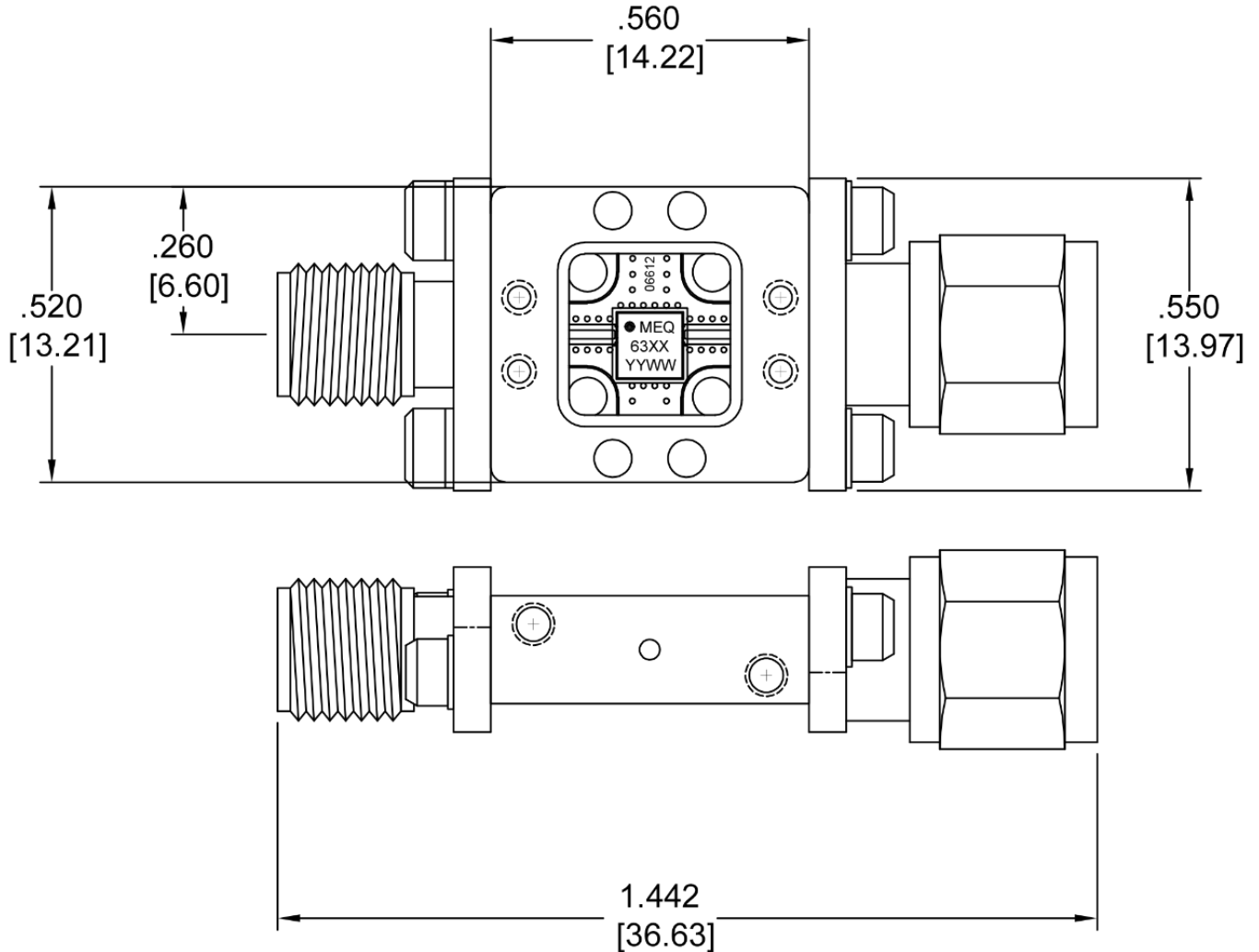

XX	Part Number
39	Eval-MEQ3-20A
40	Eval-MEQ6-20A
41	Eval-MEQ10-20A
42	Eval-MEQ5-20A
43	Eval-MEQ7-20A
45	Eval-MEQ11-20A

Port	Connector Type
I	SMA Female
O	SMA Male

Note: Eval-Package Connectors are not removeable.

DISCLAIMER

MARKI MICROWAVE, INC., ("MARKI") PROVIDES TECHNICAL SPECIFICATIONS AND DATA (INCLUDING DATASHEETS), APPLICATION OR OTHER DESIGN ADVICE, WEB TOOLS, AND OTHER INFORMATION AND RESOURCES "AS IS" AND WITH ALL FAULTS. MARKI DISCLAIMS ALL WARRANTIES, EXPRESS OR IMPLIED, INCLUDING, WITHOUT LIMITATION, ANY IMPLIED WARRANTIES OF MERCHANTABILITY, FITNESS FOR A PARTICULAR PURPOSE, OR NON-INFRINGEMENT. These resources are intended for developers skilled in the art designing with Marki products. You are solely responsible for (1) selecting the appropriate products for your application, (2) designing, validating, and testing your application, and (3) ensuring your application meets applicable standards and other requirements. Marki makes no guarantee regarding the suitability of its products for any particular purpose, nor does Marki assume any liability whatsoever arising out of your use or application of any Marki product.

Marki grants you permission to use these resources only for development of an application that uses Marki products. Other reproduction or use of these resources is strictly prohibited. No license is granted to any other Marki intellectual property or to any third-party intellectual property. Marki reserves the right to make changes to the product(s) or information contained herein without notice.

MARKI MICROWAVE and T3 MIXER are trademarks or registered trademarks of Marki Microwave, Inc. All other trademarks used are the property of their respective owners.

© 2022 - 2025, Marki Microwave, Inc