

MDPX-0609CH

Passive MMIC 9 - 26.5 GHz Diplexer/Reflectionless Filter

DEVICE OVERVIEW

General Description

The MDPX-0609 is a broadband passive MMIC diplexer, a combination high pass and low pass filter, capable of multiplexing low frequency DC to 6 GHz and high frequency 9 to 26.5 GHz signals. It can also be used as a reflectionless high pass or low pass filter when terminated with an internal/external 50 Ohm load. Passive GaAs MMIC technology allows production of smaller filter constructions that replace larger form factor circuit board constructions. Tight fabrication tolerances allow for less unit-to-unit variation than traditional filter technologies. The MDPX-0609 is available as a connectorized module and as wire bondable die. Low unit to unit variation allows for accurate simulations using the provided S3P file taken from measured production units.

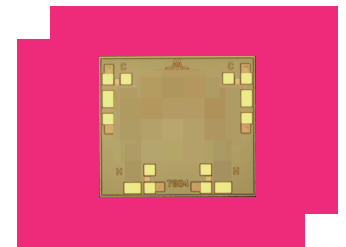

Features

- 8 GHz Crossover Point
- Low <1dB typical Insertion Loss in Pass band
- High Stop Band Suppression
- Reflectionless Filter
- RoHS Compliant

Applications

N/A

Functional Block Diagram

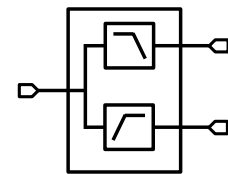

Part Ordering Options

Part Number	Description	Package	Connectors	Green Status	Product Lifecycle	Export Classification
<u>MDPX-0609</u>	Passive MMIC DC-6 GHz Diplexer/Reflectionless Filter	UB	<u>Standard</u>	REACH RoHS	Released	EAR99
MDPX-0609CH	Passive MMIC 9 - 26.5 GHz Diplexer/Reflectionless Filter	CH	-	REACH RoHS	Released	EAR99

MDPX-0609CH

Passive MMIC 9 - 26.5 GHz

Diplexer/Reflectionless Filter

Table Of Contents

- **Device Overview**
 - General Description
 - Features
 - Applications
 - Functional Block Diagram
- **Port Configuration and Functions**
 - Port Diagram
 - Port Functions
- **Revision History**
- **Specifications**
 - Absolute Maximum Ratings
 - Package Information
 - Electrical Specifications
 - Typical Performance Plots
 - MDPX-0609 Typical Performance Plots
 - MDPX-0609 Typical Performance Plots over temperature
- **Die Mounting Recommendations**
 - Mounting and Bounding Recommendations
- **Mechanical Data**
 - Outline Drawing
- **Notes**

Revision History

Revision Code	Revision Date	Comment
-	2021-07-01	Datasheet initial Release
A	2022-03-01	CH Wire Bondable Die Added

Port Configuration and Functions

Port Diagram

The MDPX-0609CH can be used as a Diplexer, reflectionless LPF, or reflectionless HPF depending on the configuration of each port which can be seen below in the Configuration Array. For configuration A, input to the diplexer is port 1, port 2 will be the output after passing through the HPF, port 3 will be terminated with port 3R, port 4 will be the output after passing through the LPF.

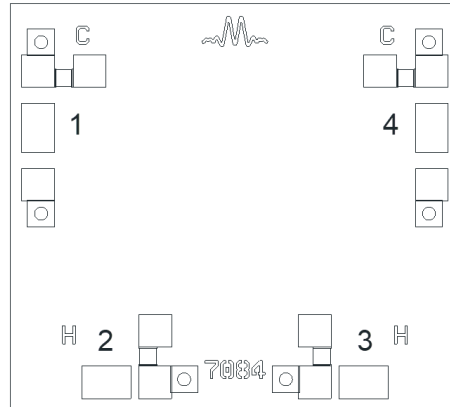

Port Functions

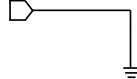
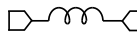
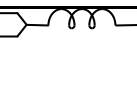
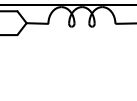
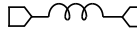

Configuration A

Port	Function	Description	Equivalent Circuit for Package
GND	Ground	CH package ground path is provided through the substrate and ground bond pads.	
Pad 1	Input/common	Pad 1 is DC short to Pad 4 and open to the other two pads and ground.	
Pad 2	High Pass Filter	Pad 2 is DC short to ground and open to all other pads.	
Pad 3	Terminated	Pad 3 is DC short to ground and open to all other pads.	
Pad 4	Low Pass Filter	Pad 4 is DC short to Pad 1 and open to the other two pads and ground.	

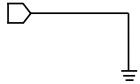
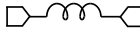
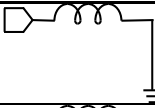
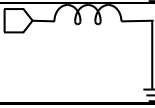
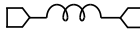

Configuration B

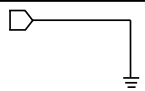
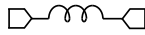
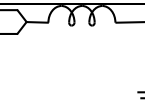
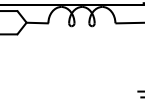
Port	Function	Description	Equivalent Circuit for Package
GND	Ground	CH package ground path is provided through the substrate and ground bond pads.	
Pad 1	Low Pass Filter	Pad 1 is DC short to Pad 4 and open to the other two pads and ground.	
Pad 2	Terminated	Pad 2 is DC short to ground and open to all other pads.	
Pad 3	High Pass Filter	Pad 3 is DC short to ground and open to all other pads.	
Pad 4	Input/common	Pad 4 is DC short to Pad 1 and open to the other two pads and ground.	

Configuration C

Port	Function	Description	Equivalent Circuit for Package
GND	Ground	CH package ground path is provided through the substrate and ground bond pads.	
Pad 1	Input/common	Pad 1 is DC short to Pad 4 and open to the other two pads and ground.	
Pad 2	High Pass Filter	Pad 2 is DC short to ground and open to all other pads.	
Pad 3	Terminated	Pad 3 is DC short to ground and open to all other pads.	
Pad 4	Terminated	Pad 4 is DC short to Pad 1 and open to the other two pads and ground.	

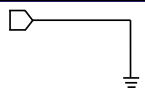
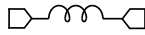
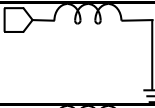
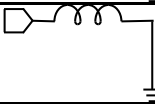

Configuration D

Port	Function	Description	Equivalent Circuit for Package
GND	Ground	CH package ground path is provided through the substrate and ground bond pads.	
Pad 1	Terminated	Pad 1 is DC short to Pad 4 and open to the other two pads and ground.	
Pad 2	Terminated	Pad 2 is DC short to ground and open to all other pads.	
Pad 3	High Pass Filter	Pad 3 is DC short to ground and open to all other pads.	
Pad 4	Input/common	Pad 4 is DC short to Pad 1 and open to the other two pads and ground.	

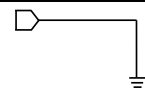
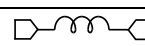
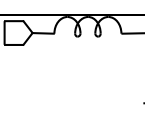
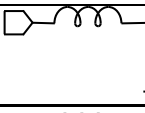
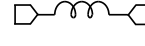
Configuration E

Port	Function	Description	Equivalent Circuit for Package
GND	Ground	CH package ground path is provided through the substrate and ground bond pads.	
Pad 1	Input/common	Pad 1 is DC short to Pad 4 and open to the other two pads and ground.	
Pad 2	Terminated	Pad 2 is DC short to ground and open to all other pads.	
Pad 3	Terminated	Pad 3 is DC short to ground and open to all other pads.	
Pad 4	Low Pass Filter	Pad 4 is DC short to Pad 1 and open to the other two pads and ground.	

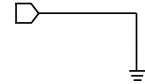
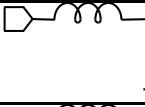
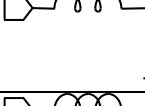
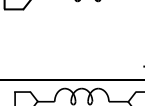
Configuration F

Port	Function	Description	Equivalent Circuit for Package
GND	Ground	CH package ground path is provided through the substrate and ground bond pads.	
Pad 1	Low Pass Filter	Pad 1 is DC short to Pad 4 and open to the other two pads and ground.	
Pad 2	Terminated	Pad 2 is DC short to ground and open to all other pads.	
Pad 3	Terminated	Pad 3 is DC short to ground and open to all other pads.	
Pad 4	Input/common	Pad 4 is DC short to Pad 1 and open to the other two pads and ground.	

Specifications

Absolute Maximum Ratings

Parameter	Maximum Rating	Unit
Maximum Storage Temperature	100	°C
Maximum Survivable Operating Temperature	100	°C
Minimum Storage Temperature	-65	°C
Minimum Survivable Operating Temperature	-65	°C
RF Power Handling	30	dBm
Spec Guaranteed Operating Temperature	25	°C

Package Information

Parameter	Details	Rating
Dimensions	-	1.38 x 1.25 mm

Electrical Specifications

Specifications guaranteed +25°C for UB package, measured in a 50Ω system.

Parameter	Port Configuration	Test Conditions	Minimum Frequency (GHz)	Maximum Frequency (GHz)	Min	Typ	Max	Unit
30 dBc Low Pass Rejection Point	-	-	0	4	20	51	-	dB
Common Port Return Loss	-	-	9	26.5	7	15	-	dB
Common Port Return Loss	-	-	0	6	13	22	-	dB
High Frequency Passband	-	-	-	-	9	-	26.5	GHz
High Pass Filter, Pass Band Insertion Loss	-	-	9	26.5	-	1	-	dB
High Pass Filter, Pass Band Return Loss	-	-	9	26.5	7	15	-	dB
Impedance	-	-	-	-	-	50	-	Ω
Isolation	-	-	12	26.5	30	58	-	dB
Isolation	-	-	4	6	-	25	-	dB
Isolation	-	-	0	4	20	51	-	dB
Low Frequency Passband	-	-	-	-	0	-	6	GHz
Low Pass Filter, Pass Band Insertion Loss	-	-	0	6	-	0.9	-	dB
Low Pass Filter, Pass Band Return Loss	-	-	0	6	13	22	-	dB
Low Pass Filter, Stop Band Rejection	-	-	12	26.5	30	47	-	dB

Typical Performance Plots

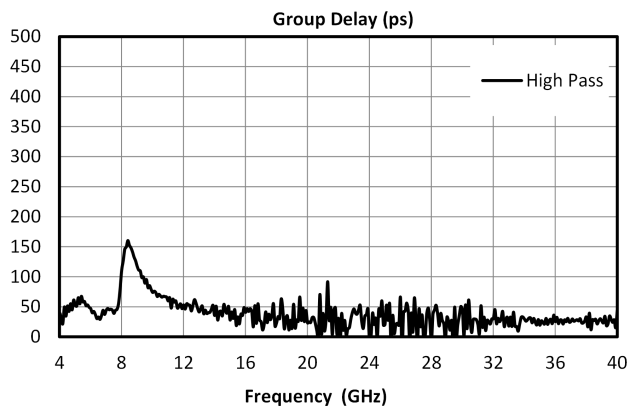
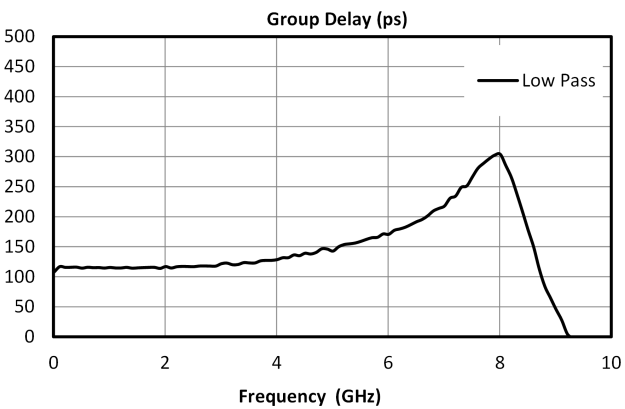
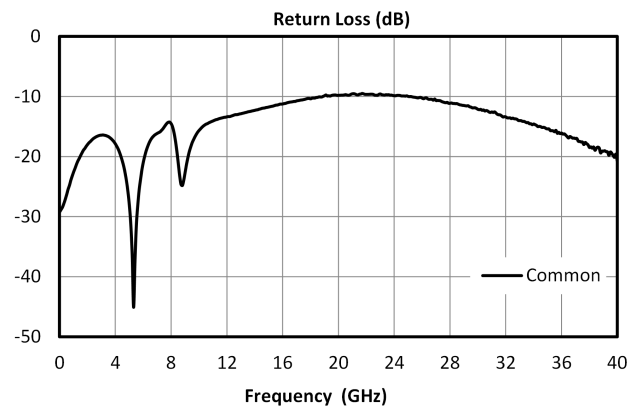
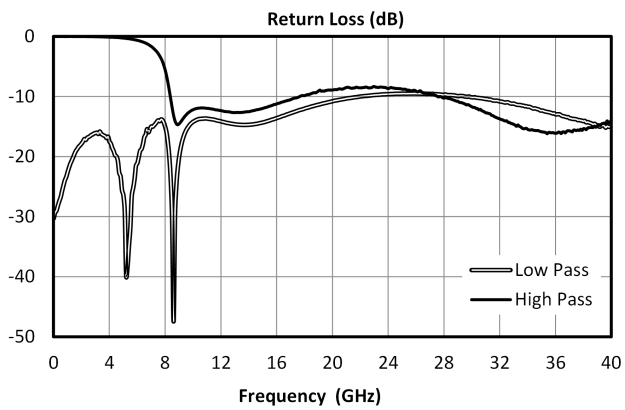
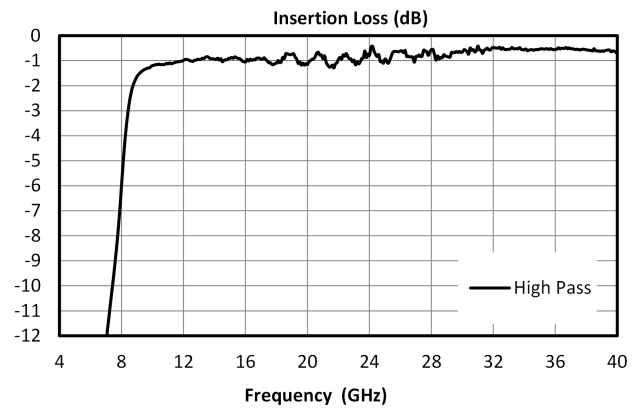
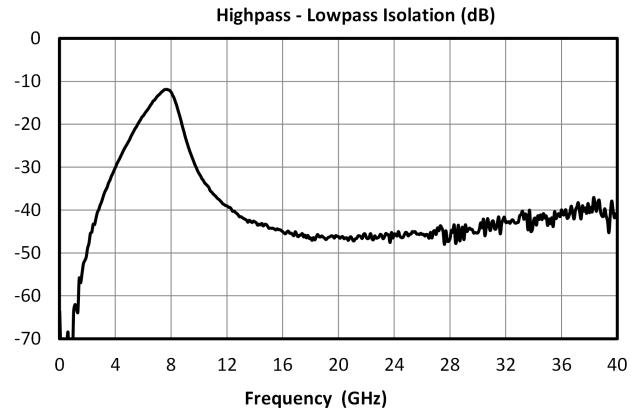
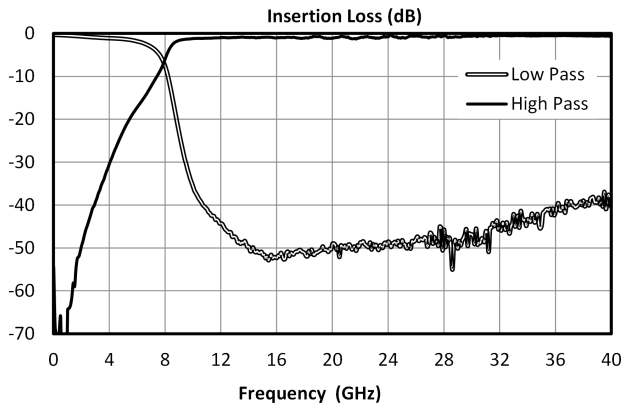

MDPX-0609 - Typical Performance Plots

Performance plots for the connectorized module are shown for measurements where directly probed measurements of the die are unavailable. Note that the following measurements include losses from connectors and microstrip traces.

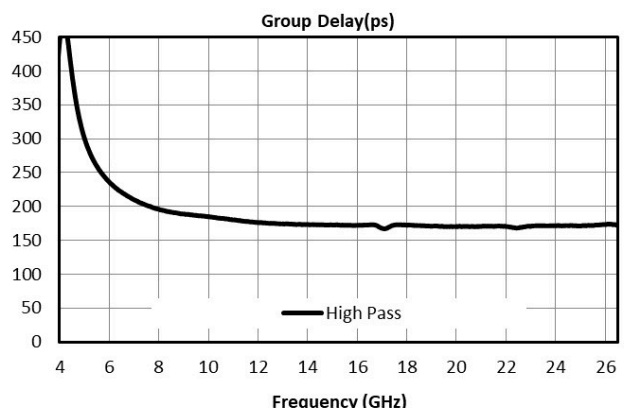
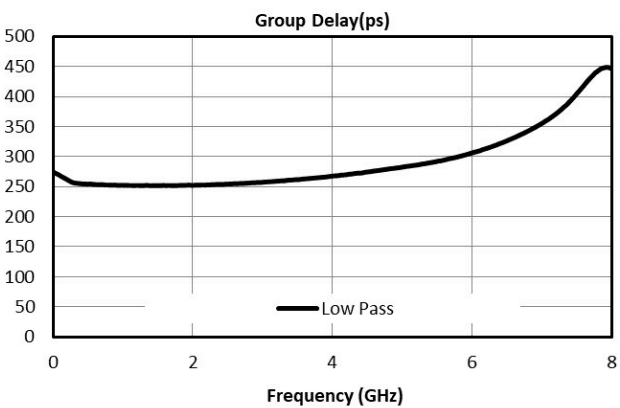
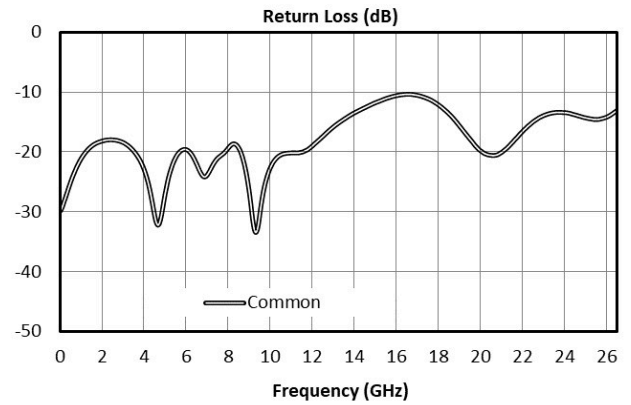
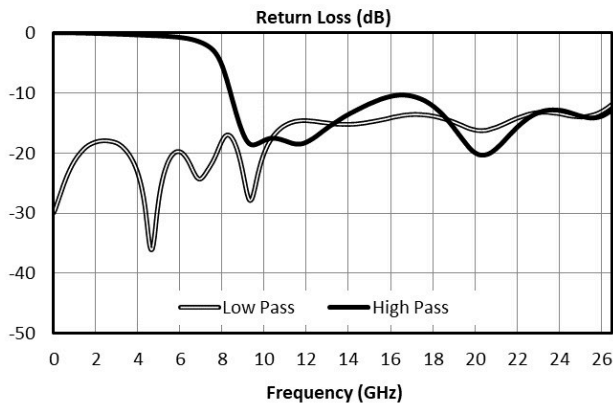
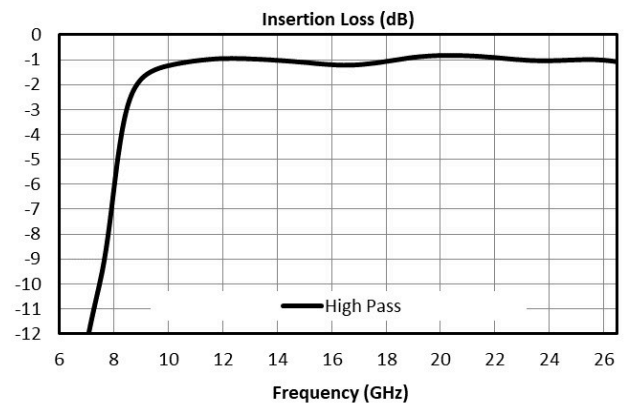
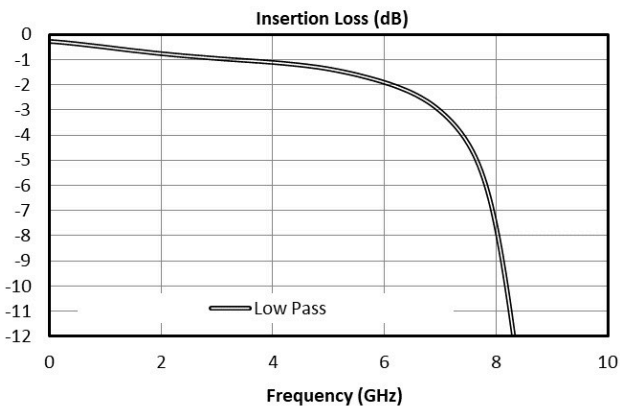
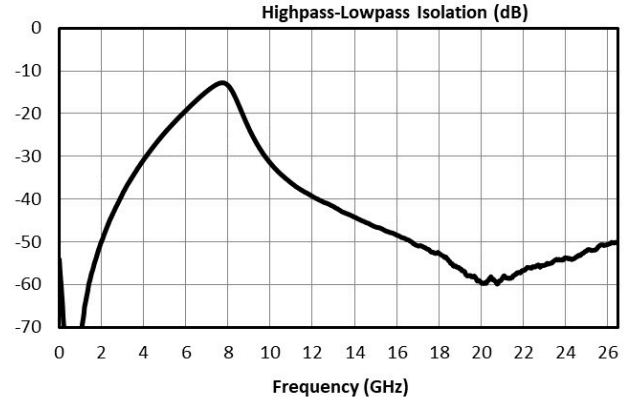
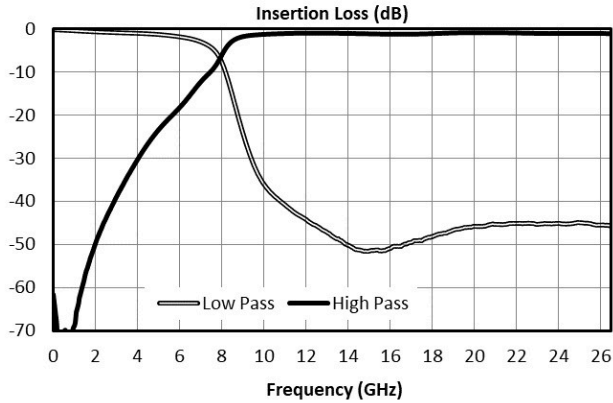

MDPX-0609 - Typical Performance Plots over temperature

Performance plots for the connectorized module are shown for measurements where directly probed measurements of the die are unavailable. Note that the following measurements include losses from connectors and microstrip traces.

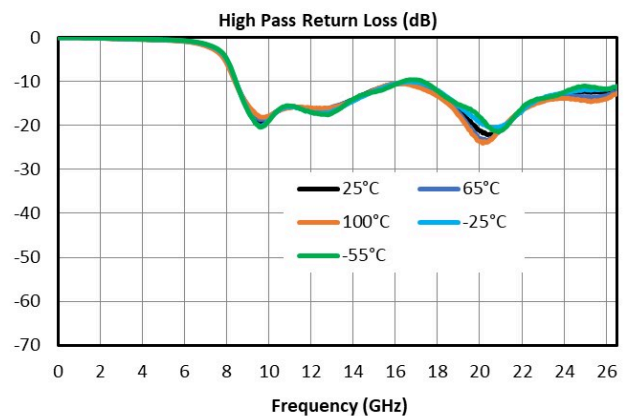
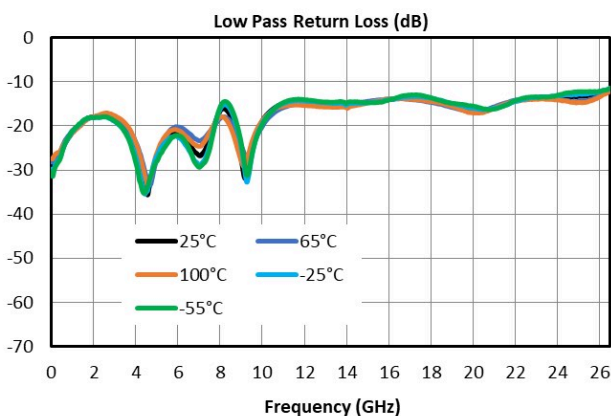
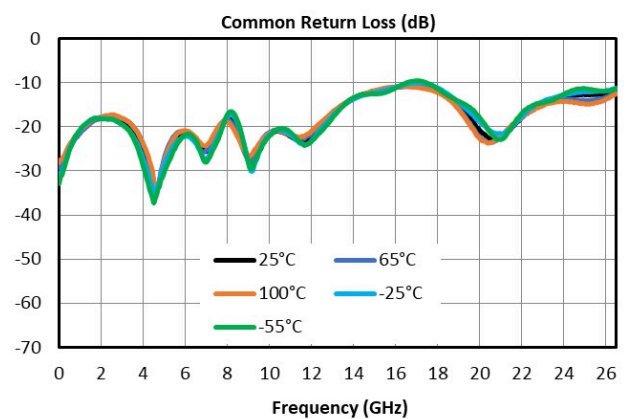
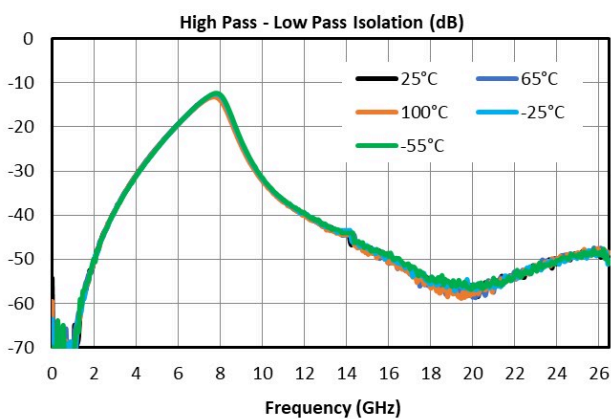
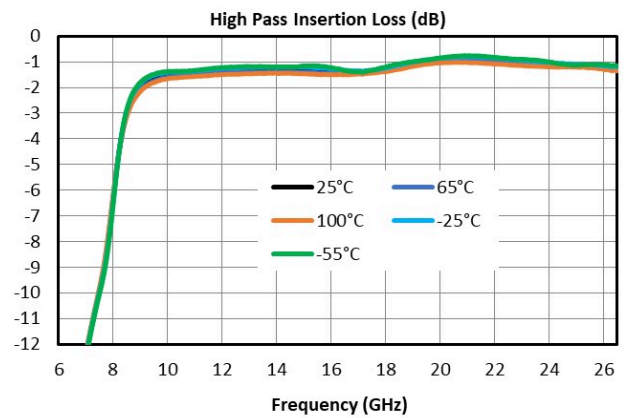
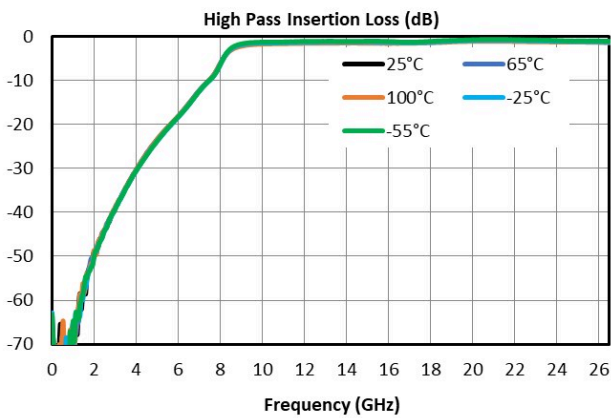
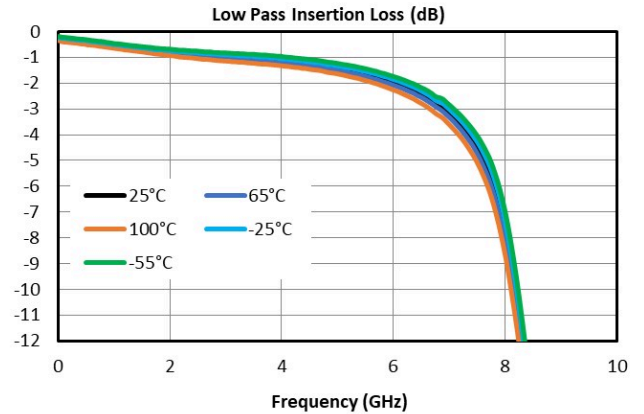
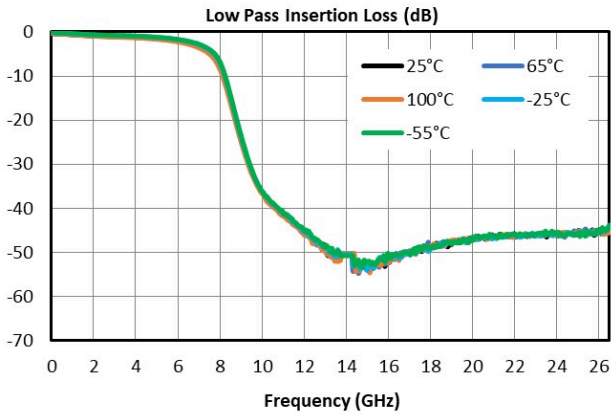

Die Mounting Recommendations

Mounting and Bonding Recommendations

Marki MMICs should be attached directly to a ground plane with conductive epoxy. The ground plane electrical impedance should be as low as practically possible. This will prevent resonances and permit the best possible electrical performance. Datasheet performance is only guaranteed in an environment with a low electrical impedance ground.

Mounting - To epoxy the chip, apply a minimum amount of conductive epoxy to the mounting surface so that a thin epoxy fillet is observed around the perimeter of the chip. Cure epoxy according to manufacturer instructions.

Wire Bonding - Ball or wedge bond with 0.025 mm (1 mil) diameter pure gold wire. Thermosonic wirebonding with a nominal stage temperature of 150 °C and a ball bonding force of 40 to 50 grams or wedge bonding force of 18 to 22 grams is recommended. Use the minimum level of ultrasonic energy to achieve reliable wirebonds. Wirebonds should be started on the chip and terminated on the package or substrate. All bonds should be as short as possible <0.31 mm (12 mils).

Circuit Considerations – 50 Ω transmission lines should be used for all high frequency connections in and out of the chip. Wirebonds should be kept as short as possible, with multiple wirebonds recommended for higher frequency connections to reduce parasitic inductance. In circumstances where the chip more than .001” thinner than the substrate, a heat spreading spacer tab is optional to further reduce bondwire length and parasitic inductance.

MDPX-0609CH

Passive MMIC 9 - 26.5 GHz

Diplexer/Reflectionless Filter

Handling Precautions

General Handling

Chips should be handled with care using tweezers or a vacuum collet. Users should take precautions to protect chips from direct human contact that can deposit contaminants, like perspiration and skin oils on any of the chip's surfaces.

Static Sensitivity

GaAs MMIC devices are sensitive to ESD and should be handled, assembled, tested, and transported only in static protected environments.

Cleaning and Storage: Do not attempt to clean the chip with a liquid cleaning system or expose the bare chips to liquid. Once the ESD sensitive bags the chips are stored in are opened, chips should be stored in a dry nitrogen atmosphere

Bonding Diagram For Configuration A

Note: Any configurations which require a termination at port N will Wirebond from port N to port NR – see example of Configuration A below which has Port 3 terminated.

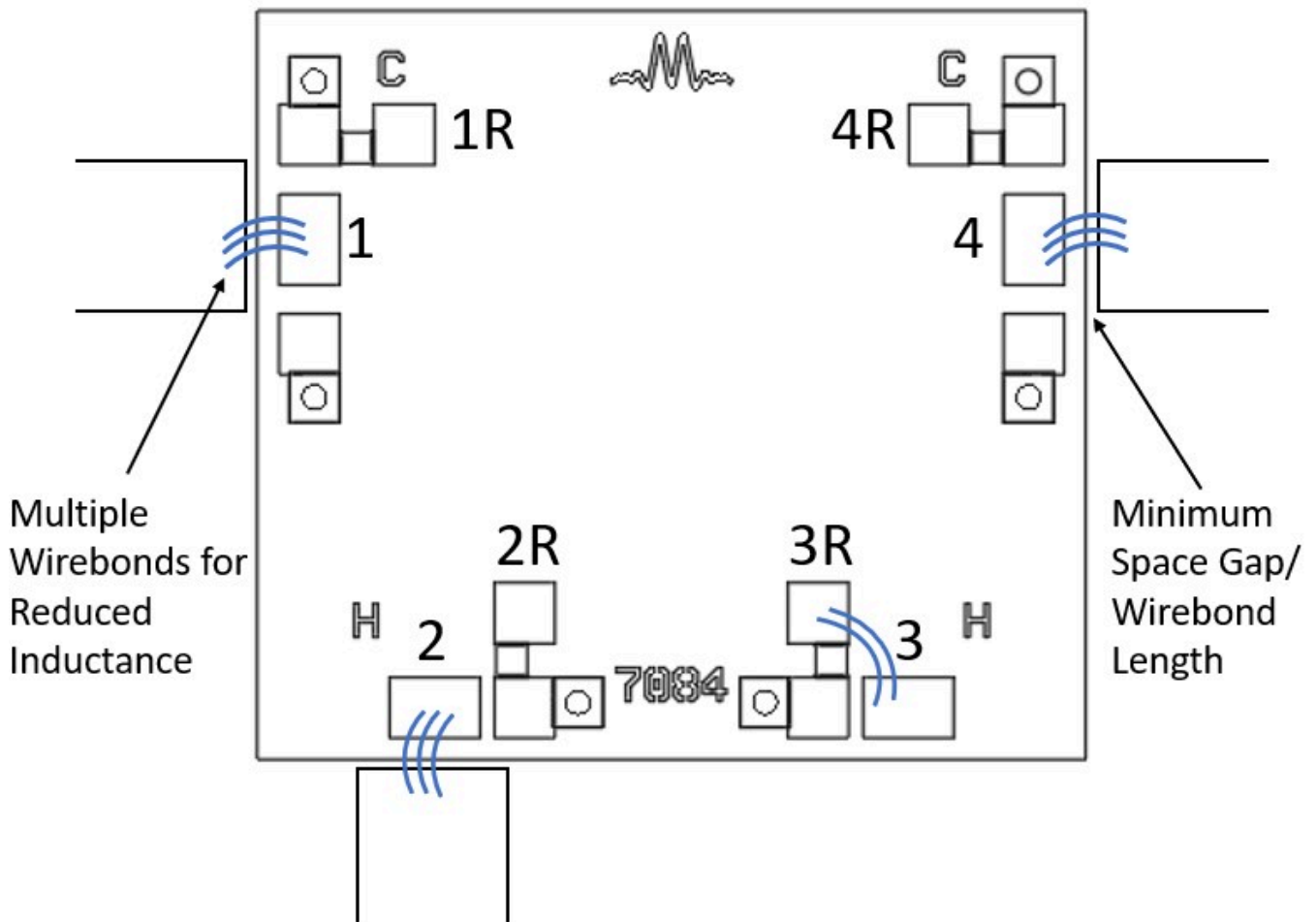

Mechanical Data

Outline Drawing

Download : [Outline 2D Drawing](#)

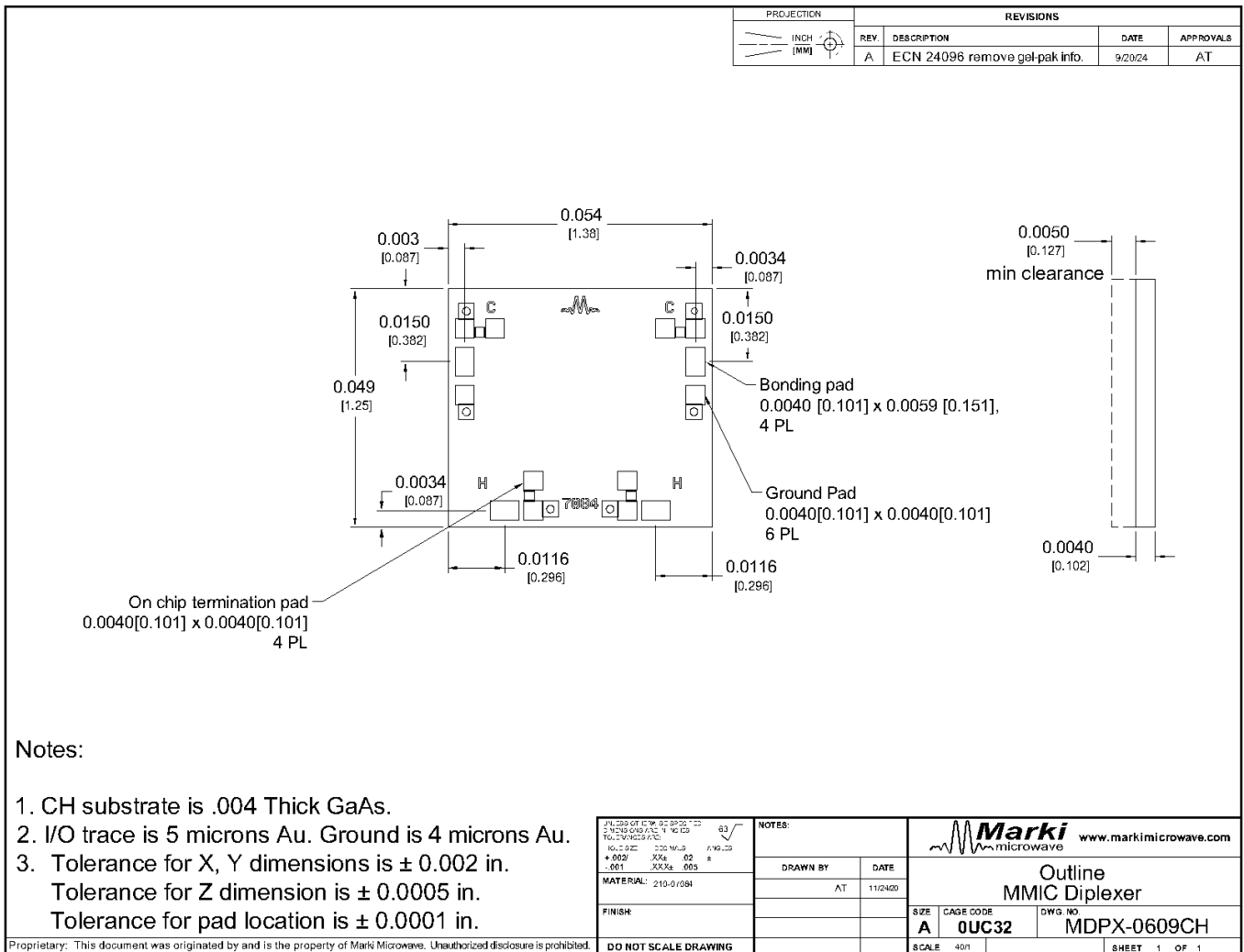

Notes:

1. CH substrate is .004 Thick GaAs.
2. I/O trace is 5 microns Au. Ground is 4 microns Au.
3. Tolerance for X, Y dimensions is ± 0.002 in.
 Tolerance for Z dimension is ± 0.0005 in.
 Tolerance for pad location is ± 0.0001 in.

Notes

1. Group delay calculated using wrapped phase response.
2. Specifications are subject to change without notice. Contact Marki Microwave for the most recent specifications and data sheets.
3. Catalog circuits are continually improved. Configuration control requires custom model numbers and specifications.

Note: Exposure to maximum rating conditions for extended periods may reduce device reliability. There is no damage to device with only one parameter set at the limit and all other parameters set at or below their nominal value. Exceeding any of the limits listed here may result in permanent damage to the device.

DISCLAIMER

MARKI MICROWAVE, INC., ("MARKI") PROVIDES TECHNICAL SPECIFICATIONS AND DATA (INCLUDING DATASHEETS), APPLICATION OR OTHER DESIGN ADVICE, WEB TOOLS, AND OTHER INFORMATION AND RESOURCES "AS IS" AND WITH ALL FAULTS. MARKI DISCLAIMS ALL WARRANTIES, EXPRESS OR IMPLIED, INCLUDING, WITHOUT LIMITATION, ANY IMPLIED WARRANTIES OF MERCHANTABILITY, FITNESS FOR A PARTICULAR PURPOSE, OR NON-INFRINGEMENT.

These resources are intended for developers skilled in the art designing with Marki products. You are solely responsible for (1) selecting the appropriate products for your application, (2) designing, validating, and testing your application, and (3) ensuring your application meets applicable standards and other requirements. Marki makes no guarantee regarding the suitability of its products for any particular purpose, nor does Marki assume any liability whatsoever arising out of your use or application of any Marki product.

Marki grants you permission to use these resources only for development of an application that uses Marki products. Other reproduction or use of these resources is strictly prohibited. No license is granted to any other Marki intellectual property or to any third-party intellectual property. Marki reserves the right to make changes to the product(s) or information contained herein without notice.

MARKI MICROWAVE and T3 MIXER are trademarks or registered trademarks of Marki Microwave, Inc. All other trademarks used are the property of their respective owners.

© 2021 - 2022, Marki Microwave, Inc