

M4-0040LJV

Double-Balanced 0.5 - 40 Mixer

DEVICE OVERVIEW

General Description

M4 diplexed IF mixers are hybrid assemblies that combine a low frequency IF (to DC) with a multi-decade bandwidth RF and LO. M4 mixers are commonly used for single tone analyzers (such as antenna test systems) with ultra-broad frequency ranges.

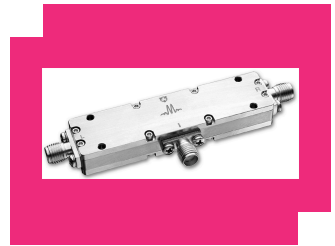

Features

- LO/RF 0.5 to 40.0 GHz
- IF DC to 400 MHz
- 8.0 dB Typical Conversion Loss
- 30 dB Typical LO to RF Isolation
- Super-Broadband RF and LO
- Available with 2.92 or 2.40 mm Connectors

Applications

N/A

Functional Block Diagram

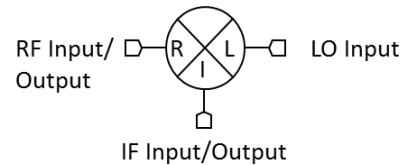

Part Ordering Options

Part Number	Description	Package	Connectors	Green Status	Product Lifecycle	Export Classification	Recommended Replacement
M4-0040LJV	Double-Balanced 0.5 - 40 Mixer	JVV	<u>Standard</u>	<u>Consult Factory</u>	Not Recommended for New Design	EAR99	-
<u>M4-0040HJ</u>	Double-Balanced 0.5 - 40 Mixer	J	<u>Standard</u>	<u>Consult Factory</u>	End of Life	EAR99	-
<u>M4-0040LJ</u>	Double-Balanced 0.5 - 40 Mixer	J	<u>Standard</u>	Non-RoHS	Not Recommended for New Design	EAR99	-

Table Of Contents

- **Device Overview**
 - General Description
 - Features
 - Applications
 - Functional Block Diagram
- **Port Configuration and Functions**
 - Port Diagram
 - Port Functions
- **Revision History**
- **Specifications**
 - Package Information
 - Recommended Operating Conditions
 - Electrical Specifications
 - Typical Performance Plots
- **Mechanical Data**
 - Outline Drawing
- **Notes**

Revision History

Revision Code	Revision Date	Comment
-	2007-03-01	Datasheet initial Release
A	2019-06-01	H-Diode Spec Removed
B	2025-01-29	Updated Conversion Loss as per ECN

Port Configuration and Functions

Port Diagram

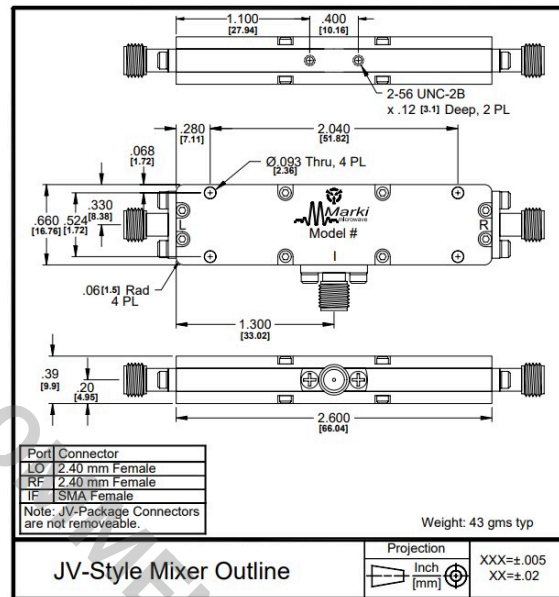

Port Functions

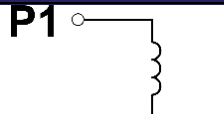
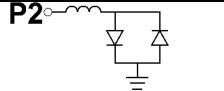
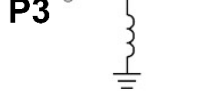
Port	Function	Connector Type	Description	Equivalent Circuit for Package
Port 1	LO	2.4F	Port 1 is DC short for the JV package.	P1 
Port 2	IF	SMAF	Port 2 is diode connected for the JV Package.	P2 
Port 3	RF	2.4F	Port 3 is DC short for the JV Package.	P3 

Specifications

Package Information

Parameter	Details	Rating
Weight	Package name: JVV	43g
Dimensions	-	66.04 x 16.76 mm

Recommended Operating Conditions

Parameter	Min	Nominal	Max	Unit
LO Input Power	10	-	13	-

NOT RECOMMENDED FOR NEW DESIGN

Electrical Specifications

Specifications guaranteed from -55 to +100°C, measured in a 50-Ohm system.

Parameter	Test Conditions	Min	Typ	Max	Unit
Conversion Loss ¹	RF/LO=0.5-40 GHz IF=91MHz	-	7	13.5	dB
Input 1 dB Compression	RF/LO=0.5-40 GHz L Diode drive level=10-13 dBm	-	3	-	dBm
Input IP3	RF/LO=0.5-40 GHz L Diode drive level=10-13 dBm	-	13	-	dBm
Isolation, RF to IF	RF/LO=0.5-40 GHz	-	25	-	dB
IF Frequency Range	-	0	-	0.4	GHz
Isolation, LO to RF	-	-	30	-	dB
RF Frequency Range	-	0.5	-	40	GHz

^[1] RF frequency range guaranteed with high side LO. Using a LO frequency lower than the RF frequency, will reduce the low end of the RF frequency range.

NOT RECOMMENDED FOR NEW DESIGN

Typical Performance Plots

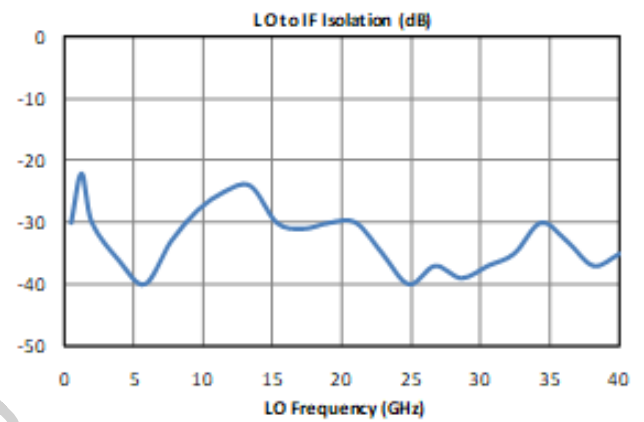
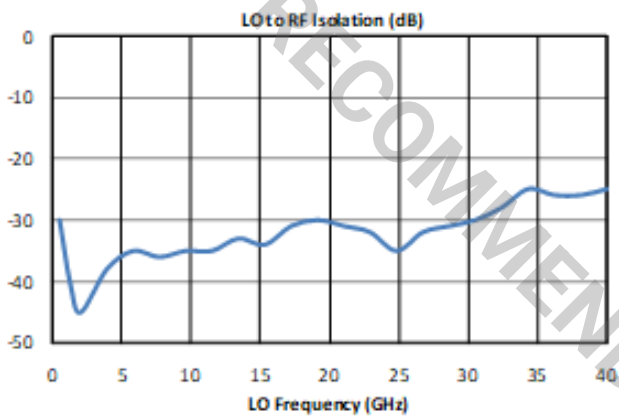
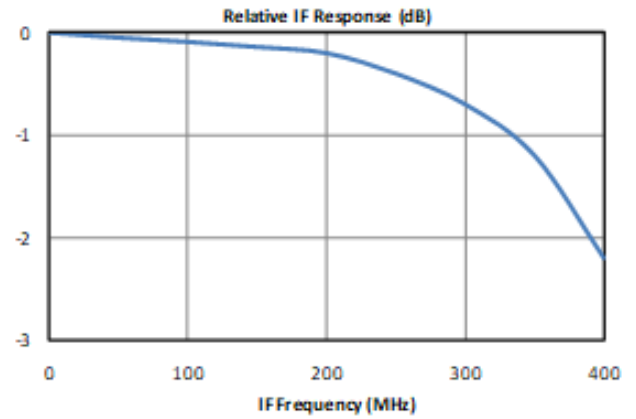
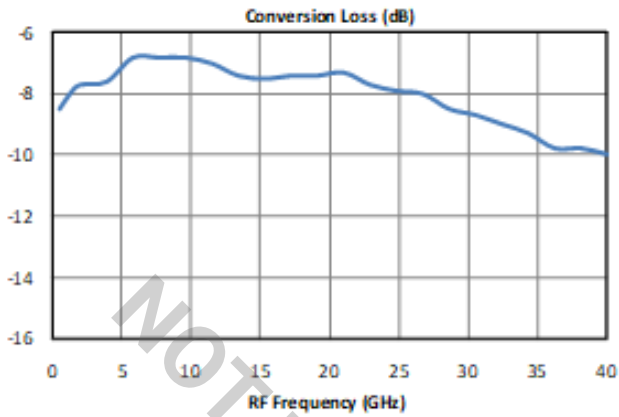

Mechanical Data

Outline Drawing

Download : [Outline 3D Drawing](#) | [Outline 3D STP](#)

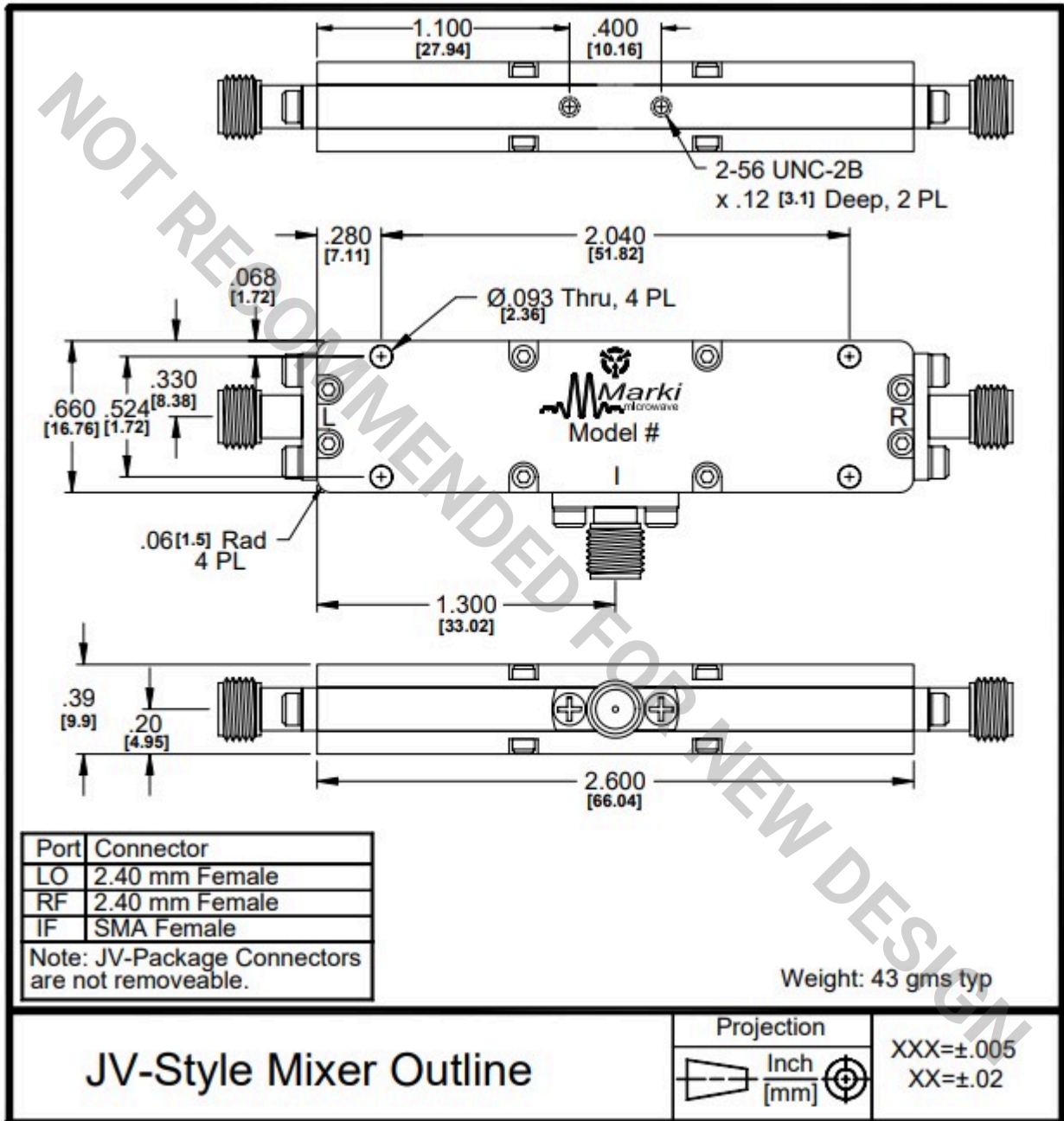

Notes

1. Mixer Conversion Loss Plot is done with an IF frequency of 100 MHz.
2. Mixer Noise Figure typically measures within +0.5 dB of conversion loss for IF frequencies greater than 5 MHz.
3. Conversion Loss typically degrades less than 0.5 dB for LO drives 2 dB below the lowest and 3 dB above highest nominal LO drive levels.
4. Conversion Loss typically degrades less than 0.5 dB at +100°C and improves less than 0.5 dB at -55°C.
5. Maximum input power is +23 dBm at +25°C, derated linearly to +20 dBm at +100°C.
6. Specifications are subject to change without notice. Contact Marki Microwave for the most recent specifications and data sheets.
7. Catalog mixer circuits are continually improved. Configuration control requires custom mixer model numbers and specifications.

DISCLAIMER

MARKI MICROWAVE, INC., ("MARKI") PROVIDES TECHNICAL SPECIFICATIONS AND DATA (INCLUDING DATASHEETS), APPLICATION OR OTHER DESIGN ADVICE, WEB TOOLS, AND OTHER INFORMATION AND RESOURCES "AS IS" AND WITH ALL FAULTS. MARKI DISCLAIMS ALL WARRANTIES, EXPRESS OR IMPLIED, INCLUDING, WITHOUT LIMITATION, ANY IMPLIED WARRANTIES OF MERCHANTABILITY, FITNESS FOR A PARTICULAR PURPOSE, OR NON-INFRINGEMENT. These resources are intended for developers skilled in the art designing with Marki products. You are solely responsible for (1) selecting the appropriate products for your application, (2) designing, validating, and testing your application, and (3) ensuring your application meets applicable standards and other requirements. Marki makes no guarantee regarding the suitability of its products for any particular purpose, nor does Marki assume any liability whatsoever arising out of your use or application of any Marki product.

Marki grants you permission to use these resources only for development of an application that uses Marki products. Other reproduction or use of these resources is strictly prohibited. No license is granted to any other Marki intellectual property or to any third-party intellectual property. Marki reserves the right to make changes to the product(s) or information contained herein without notice.

MARKI MICROWAVE and T3 MIXER are trademarks or registered trademarks of Marki Microwave, Inc. All other trademarks used are the property of their respective owners.

© 2007, 2019, 2025, Marki Microwave, Inc