

AMM-7200UC

12 GHz – 46 GHz GaAs Driver Amplifier

DEVICE OVERVIEW

General Description

The AMM-7200 is a general-purpose broadband MMIC driver amplifier that provides +21 dBm output power suitable for driving a Marki H or L diode mixer at 12-46 GHz and S diode mixer from 14-40 GHz. The amplifier also has excellent return losses and a small die size which allows it to be used in a variety of applications. It has built in DC-blocking capacitors on the input and output.

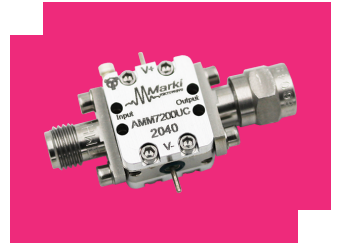

Features

- +21 dBm Output Power
- 18 dB gain
- Excellent Return Losses
- Small Die size

Applications

- Mobile test and measurement equipment
- 5G transceivers
- Driver amplifier L,H,S – diode mixers
- Radar
- SATCOM

Functional Block Diagram

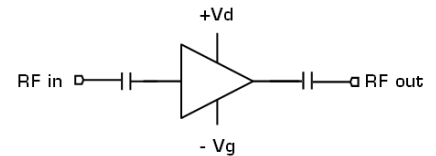

Part Ordering Options

| Part Number | Description | Package | Connectors | Green Status | Product Lifecycle | Export Classification |
|---------------------|---------------------------------------|---------|-----------------|---------------|-------------------|-----------------------|
| <u>AMM-7200UC-K</u> | 12 GHz – 40 GHz GaAs Driver Amplifier | UC | - | RoHS RoHS | Released | EAR99 |
| AMM-7200UC | 12 GHz – 46 GHz GaAs Driver Amplifier | UC | <u>Standard</u> | REACH RoHS | Released | EAR99 |

Table Of Contents

■ Device Overview

- General Description
- Features
- Applications
- Functional Block Diagram

■ Port Configuration and Functions

- Port Diagram
- Port Functions

■ Revision History

■ Specifications

- Absolute Maximum Ratings
- Fit and MTTF Table
- Package Information
- Recommended Operating Conditions
- Sequencing Requirements
- Electrical Specifications
- AMM-7200UC Typical Performance Plots
- Typical Marki Mixer Performance Plots with AMM-7200UC LO Driver

■ Operation

- Application Information

■ Mechanical Data

- Outline Drawing

Revision History

| Revision Code | Revision Date | Comment |
|---------------|---------------|---------------------------|
| - | 2021-05-01 | Datasheet Initial Release |
| A | 2024-10-28 | 220-07200A die in build |
| B | 2026-02-13 | MTTF Table Added. |

Port Configuration and Functions

Port Diagram

A port diagram of the AMM-7200UC is shown below.

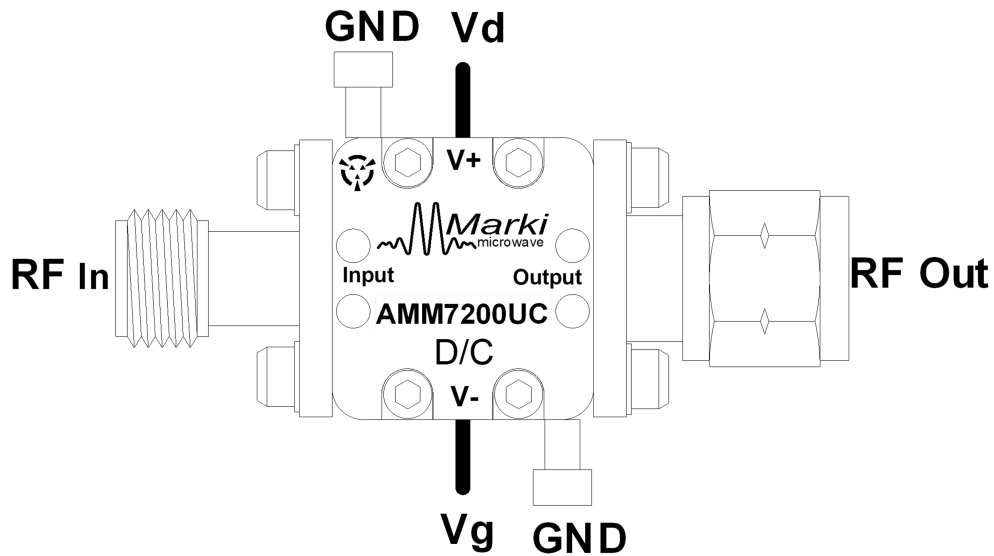

Port Functions

| Port | Function | Connector Type | Description | DC Equivalent Circuit |
|--------|------------------|----------------|---|-----------------------|
| GND | Ground | - | Exterior housing must be connected to a DC/RF ground potential with high thermal and electrical conductivity. | GND ↓ |
| RF In | RF Input | 2.4F | This is the RF Input port of the amplifier module. It is internally DC blocked and RF matched to 50 Ω. | RF In □ — — |
| RF Out | RF Output | 2.4M | This is the RF Output port of the amplifier module. It is internally DC blocked and RF matched to 50 Ω. | — — □ RF Out |
| Vd | Drain Supply Pin | - | The Vd pin supplies drain voltage to the amplifier IC. Apply gate voltage Vg before applying drain voltage. | Vd ↓ |
| Vg | Gate Bias Pin | - | The Vg pin supplies negative control voltage to the amplifier and controls the amplifier gain. Lower (more negative) voltages on a Vg pad will result in lower drain current and lower small signal gain. | Vg ↓ |

Specifications

Absolute Maximum Ratings

The Absolute Maximum Ratings indicate limits beyond which damage may occur to the device. If these limits are exceeded, the device may become inoperable or have a reduced lifetime. This amplifier is designed and characterized in a 50Ω system, and operation in a reflective environment can cause performance degradation.

| Parameter | Maximum Rating | Unit |
|---|----------------|------|
| Continuous Power Dissipation (PDISS) (at 85 °C case temp.) ¹ | 1 | W |
| Maximum Operating Temperature | 85 | °C |
| Maximum Storage Temperature | 150 | °C |
| Max Junction Temperature for MTTF > 1E6 hours | 175 | °C |
| Minimum Operating Temperature | -45 | °C |
| Minimum Storage Temperature | -65 | °C |
| Negative Bias Voltage (Vg) | -2 | V |
| Positive Drain Supply Current (Id) (with RF Input) | 450 | mA |
| Positive Drain Supply Voltage (Vd) | 4.5 | V |
| RF Input Power | 20 | dBm |
| Thermal Resistance, θJC | 90 | °C/W |

[1] Derates by 11 mW/°C above 85 °C case temperature.

FIT and MTTF Table

| T (°C) | λ (TIF) | MTTF (hr) | MTTF (yr) |
|--------|----------|-----------|-----------|
| 105 | 2,441.45 | 4.10E+05 | 47 |
| 85 | 310.48 | 3.22E+06 | 368 |
| 55 | 8.79 | 1.14E+08 | 12,992 |
| 25 | 0.12 | 8.24E+09 | 941,063 |

Package Information

| Parameter | Details | Rating |
|------------|------------------|------------------|
| Weight | Package name: UC | 12.4g |
| Dimensions | - | 13.21 x 14.22 mm |

Recommended Operating Conditions

The Recommended Operating Conditions indicate the limits, inside which the device should be operated, to guarantee the performance given in Electrical Specifications. Operating outside these limits may not necessarily cause damage to the device, but the performance may degrade outside the limits of the electrical specifications. For limits, above which damage may occur, see Absolute Maximum Ratings.

| Parameter | Min | Nominal | Max | Unit |
|--|------|---------|------|------|
| Power Supply DC Voltage (Vd) | 2.5 | 3 | 3 | V |
| Ambient Temperature | -40 | 25 | 85 | °C |
| Power Supply DC Current (Id) (No RF Input) | 115 | 180 | 300 | mA |
| Negative Bias Voltage (Vg) | -0.6 | -0.5 | -0.4 | V |
| Input Power for Saturation | 6 | 9 | 12 | dBm |

Module conditions provided for laboratory settings. Bare die operating conditions should be followed when used in test systems with extended lifetimes.

Sequencing Requirements

Turn-on Procedure:

1. Apply negative bias to Vg
2. Apply Vd

Turn-off Procedure:

1. Turn off Vd
2. Turn off Vg

Electrical Specifications

The electrical specifications apply at TA=+25°C in a 50Ω system. Min and Max limits apply only to our connectorized units and are guaranteed at TA=+25°C.

| Parameter | Test Conditions | Minimum Frequency (GHz) | Maximum Frequency (GHz) | Min | Typ | Max | Unit |
|-------------------------------------|-------------------------------|-------------------------|-------------------------|-----|------|-----|------|
| Current Consumption ¹ | 3V/-0.4V | - | - | - | 230 | - | mA |
| Current Consumption ² | 3V/-0.5V | - | - | - | 180 | - | mA |
| Current Consumption ³ | 3V/-0.6V | - | - | - | 130 | - | mA |
| Input IP3 | 3V/-0.5V, -20 dBm Input Power | 12 | 46 | - | 12 | - | dBm |
| Input Power for Saturation | 3V/-0.5V bias | 12 | 46 | - | 9 | - | dBm |
| Input Return Loss | 3V/-0.5V Bias | 12 | 46 | - | 19 | - | dB |
| Noise Figure | 3V/-0.5V bias | 12 | 46 | - | 6.3 | - | dB |
| Output IP3 | 3V/-0.5V, -20 dBm Input Power | 12 | 46 | - | 29 | - | dBm |
| Output P1dB | 3V/-0.5V bias | 12 | 46 | - | 19 | - | dBm |
| Output Return Loss | 3V/-0.5V Bias | 12 | 46 | - | 18 | - | dB |
| Reverse Isolation | 3V/-0.5V Bias | 12 | 46 | - | 52 | - | dB |
| Saturated Output Power ⁴ | 3V/-0.5V bias | 35 | 46 | - | 19.5 | - | dBm |
| Saturated Output Power ⁵ | 3V/-0.5V bias | 12 | 18 | - | 19 | - | dBm |
| Saturated Output Power ⁶ | 3V/-0.5V bias | 18 | 35 | 17 | 21.5 | - | dBm |
| Small Signal Gain | 3V/-0.5V bias | 12 | 18 | - | 17 | - | dB |
| Small Signal Gain | 3V/-0.5V bias | 35 | 46 | - | 15 | - | dB |
| Small Signal Gain | 3V/-0.5V bias | 18 | 35 | 14 | 18 | - | dB |

[1][2][3] Bias conditions tested with no RF input power. Bias conditions presented as Vd/Vg.

[4][5][6] Saturated Output Power specification defined using the AMM-7200UC P5dB compression curve shown in section 3.7.

AMM-7200UC Typical Performance Plots

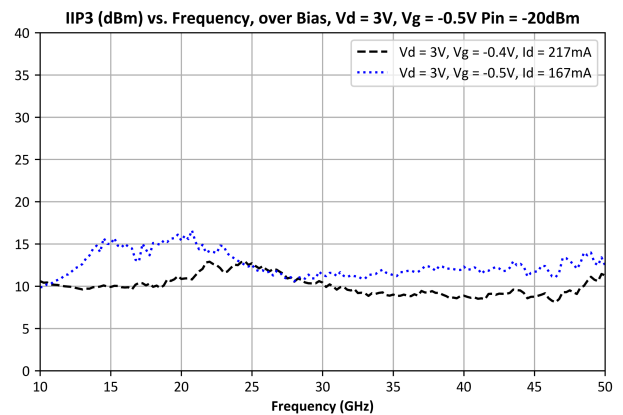
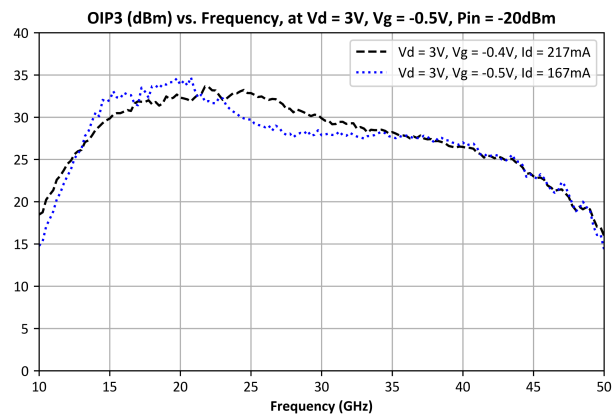
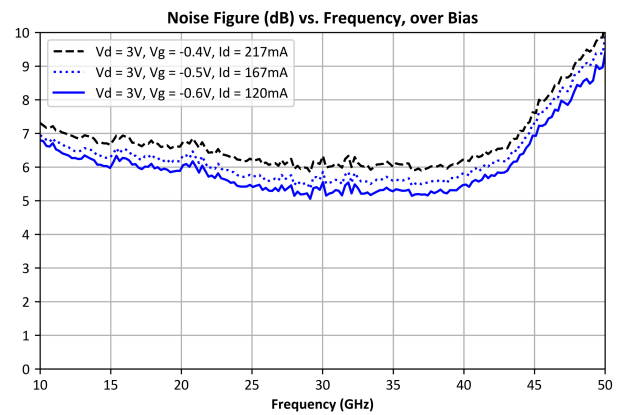
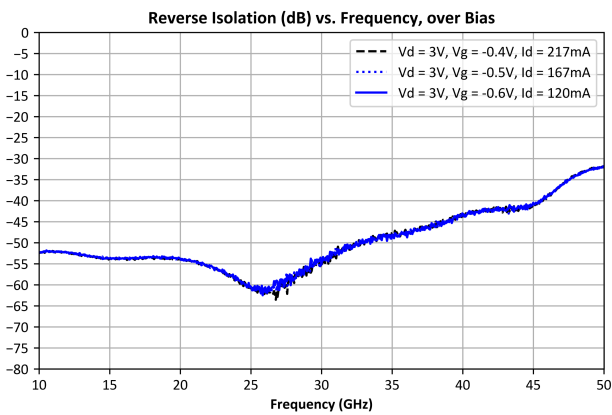
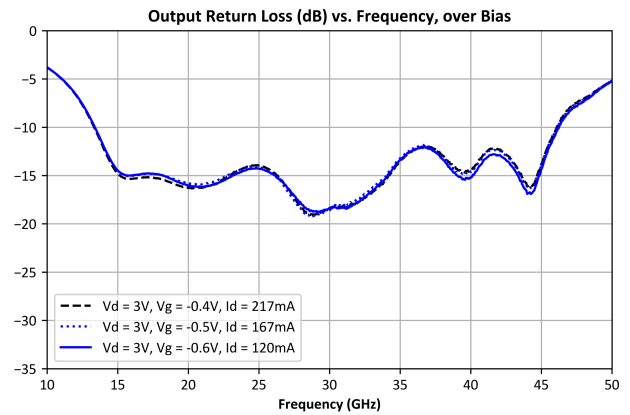
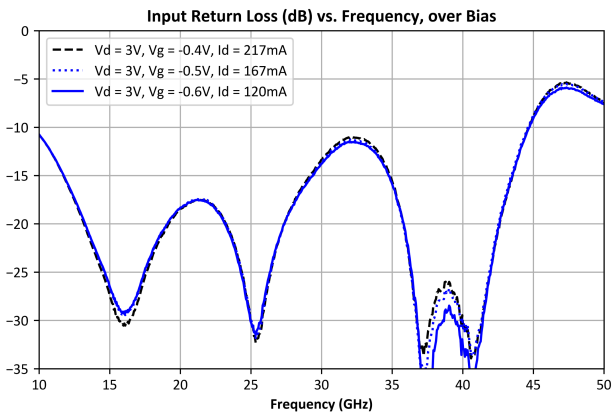
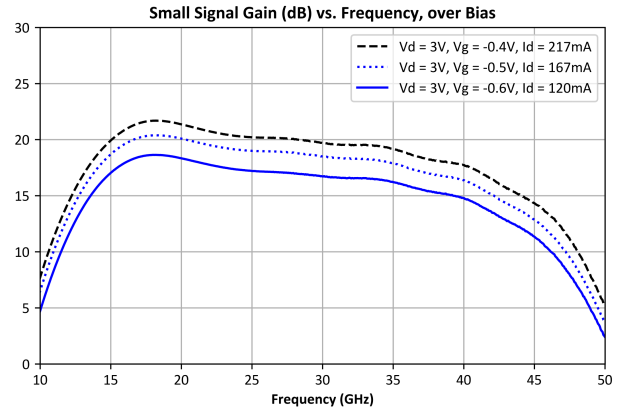
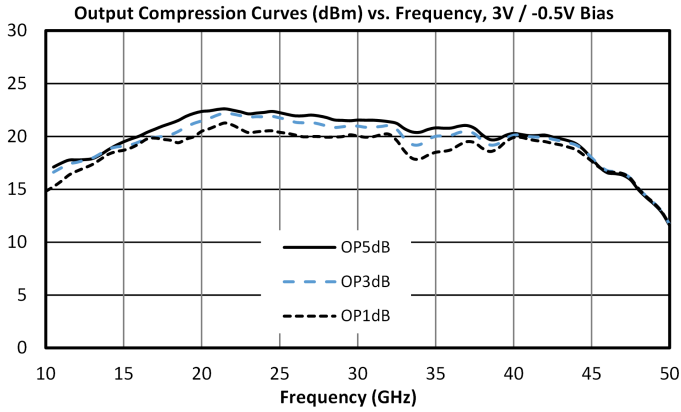

Output Power (dBm) vs. Frequency, Over Temp., 3V / -0.5V Bias

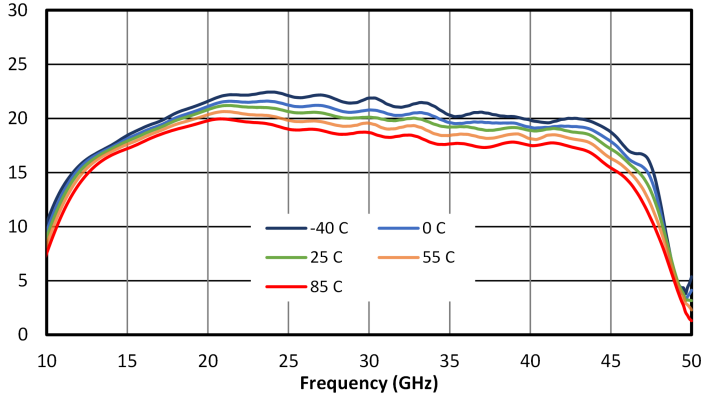

Small Signal Gain (dB) vs. Frequency, Over Temp., 3V / -0.5V Bias

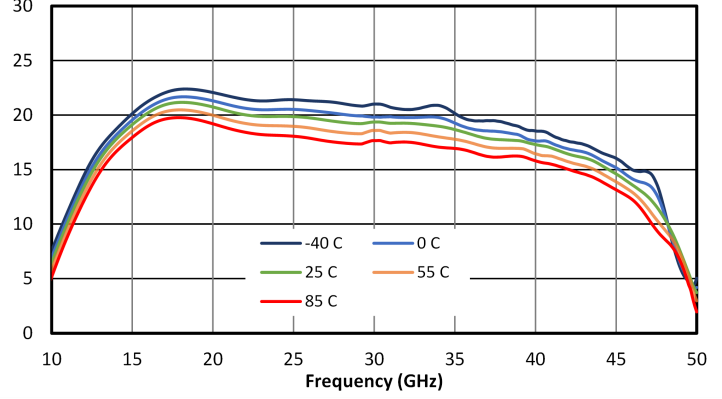

Quiescent Drain Current (mA) vs. Vd

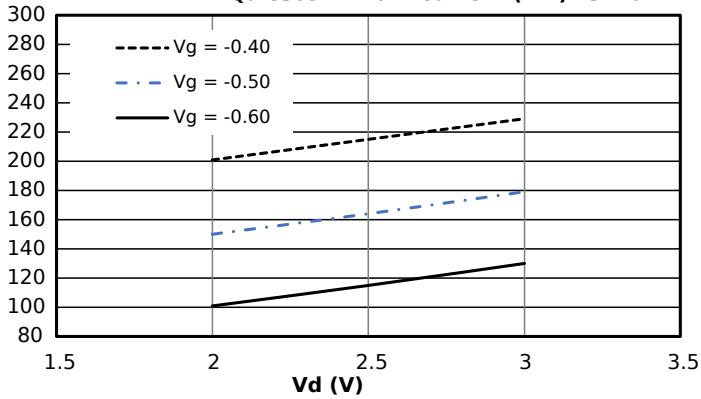

Quiescent Drain Current (mA) vs. Vg

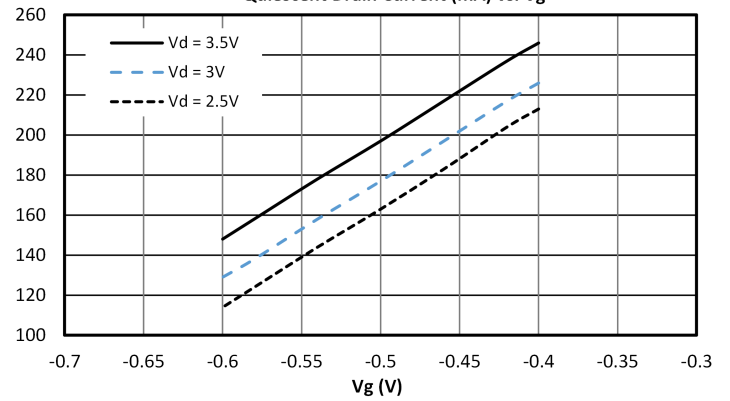

Drain Current (mA) vs. Input Power and Vg, 3Vd/

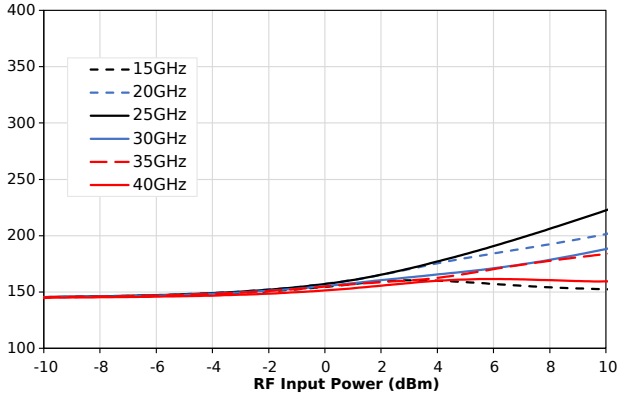

Typical Marki Mixer Performance Plots with AMM-7200UC LO Driver

LO Input Powers specified as the input power into the AMM-7200UC LO driver

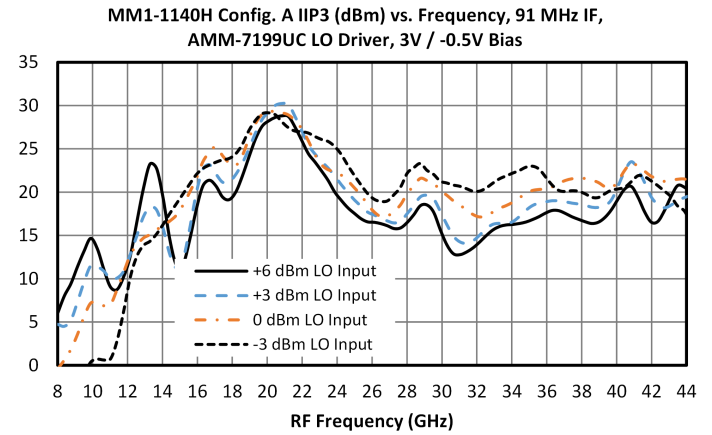
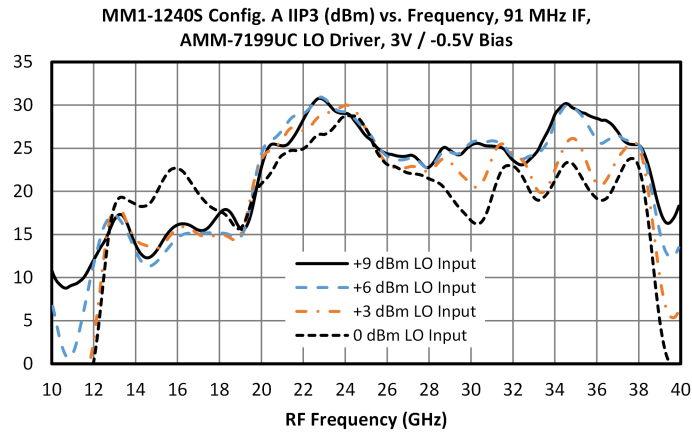
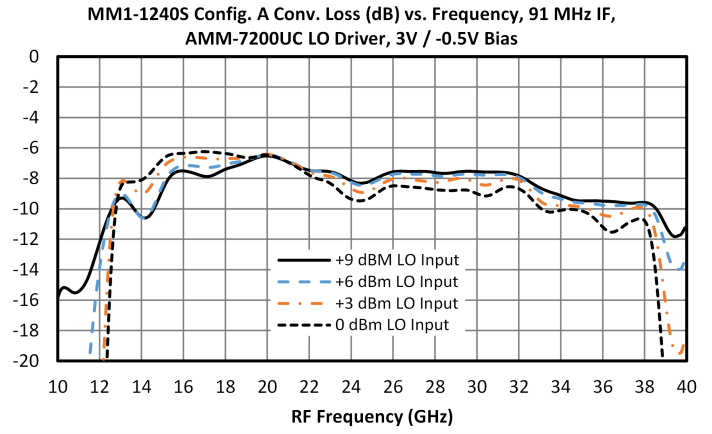
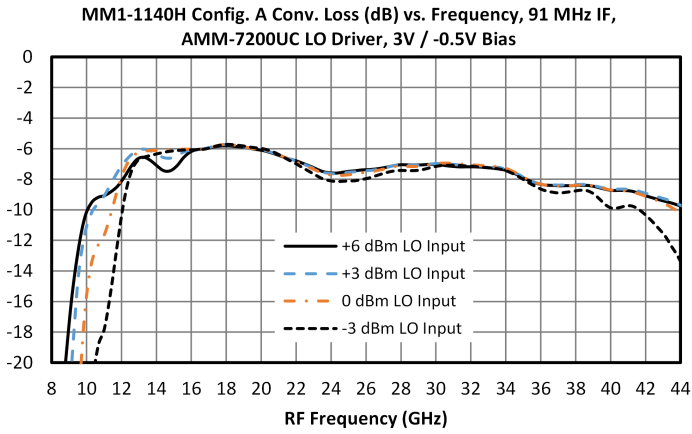

Application Information

Constant Drain Current vs. Constant Gate Voltage Operation

The AMM-7200 pHEMT amplifier can be biased with a constant gate and drain voltage, or with a constant drain current by regulating the gate voltage. Using a constant gate and drain voltage reduces circuit complexity, but has variable current consumption during operation. However, regulating the gate voltage using feedback circuitry which controls the drain current to a constant value minimizes unit-to-unit variation in gain, output power, and compression points.

Under small signal excitation at a fixed temperature, these two approaches are equivalent because the current draw versus frequency is relatively constant in small signal. However, they will diverge in large signal conditions, where the drain current is affected the input signal's frequency and power. The output power in saturation is relatively unchanged, as it is more strongly dependent on the drain voltage. However, output referred 1 dB compression point will decrease by 2-3 dB when operated with a constant drain current.

Mechanical Data

Outline Drawing

Download : [Outline 2D Drawing](#) | [Outline 3D Drawing](#) | [Outline 3D STP](#)

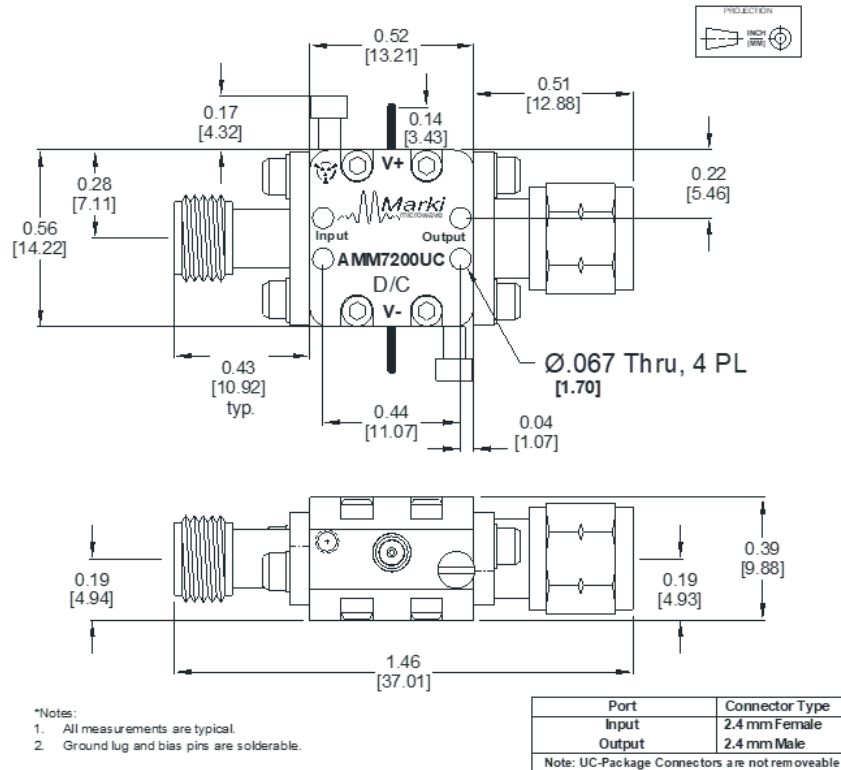

DISCLAIMER

MARKI MICROWAVE, LLC., (“MARKI”) PROVIDES TECHNICAL SPECIFICATIONS AND DATA (INCLUDING DATASHEETS), APPLICATION OR OTHER DESIGN ADVICE, WEB TOOLS, AND OTHER INFORMATION AND RESOURCES “AS IS” AND WITH ALL FAULTS. MARKI DISCLAIMS ALL WARRANTIES, EXPRESS OR IMPLIED, INCLUDING, WITHOUT LIMITATION, ANY IMPLIED WARRANTIES OF MERCHANTABILITY, FITNESS FOR A PARTICULAR PURPOSE, OR NON-INFRINGEMENT.

These resources are intended for developers skilled in the art designing with Marki products. You are solely responsible for (1) selecting the appropriate products for your application, (2) designing, validating, and testing your application, and (3) ensuring your application meets applicable standards and other requirements. Marki makes no guarantee regarding the suitability of its products for any particular purpose, nor does Marki assume any liability whatsoever arising out of your use or application of any Marki product.

Marki grants you permission to use these resources only for development of an application that uses Marki products. Other reproduction or use of these resources is strictly prohibited. No license is granted to any other Marki intellectual property or to any third-party intellectual property. Marki reserves the right to make changes to the product(s) or information contained herein without notice.

MARKI MICROWAVE and T3 MIXER are trademarks or registered trademarks of Marki Microwave, LLC. All other trademarks used are the property of their respective owners.

© 2021, 2024, 2026, Marki Microwave, LLC