

# MT3-0113HCQG-2

## GaAs MMIC High Dynamic Range Mixer

### DEVICE OVERVIEW

#### General Description

The MT3-0113HCQG is a triple balanced passive diode GaAs MMIC mixer offering high dynamic range, low conversion loss, and excellent repeatability. As with all T3 mixers, this mixer offers unparalleled nonlinear performance in terms of IIP3, P1dB, and spurious performance with a flexible LO drive requirement from +16 dBm to +24 dBm. The MT3-0113HCQG is available in a surface-mount outline, or in an SMA connectorized evaluation fixture. The MT3-0113HCQG is a superior alternative to Marki Microwave carrier and packaged T3 mixers, and is form-fit compatible with legacy T3's in the CQ and CQG footprints.

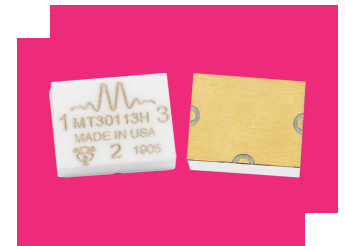

#### Features

- Form-Fit Compatible with Legacy CQ and CQG T3 Mixers
- Broadband, Overlapping RF, LO and IF
- Suitable for Up or Down Conversion
- Compatible with Sine or Square-Wave LO
- Square-Wave LO delivers Industry-Leading Spurious, IP3, and P<sub>1dB</sub> Performance

#### Applications

N/A

#### Functional Block Diagram

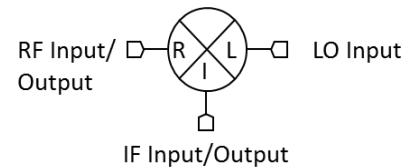

#### Part Ordering Options

Part Number	Description	Package	Packing Size	Green Status	Product Lifecycle	Export Classification
MT3-0113HCQG-1	GaAs MMIC High Dynamic Range Mixer	CQG	-	REACH RoHS	Released	EAR99
MT3-0113HCQG-2	GaAs MMIC High Dynamic Range Mixer	CQG	-	REACH RoHS	Released	EAR99
EVAL-MT3-0113H	Evaluation Board, GaAs MMIC High Dynamic Range Mixer	EVAL	-	REACH RoHS	Released	EAR99
MT3-0113H-2-TR	Tape and Reel, GaAs MMIC High Dynamic Range Mixer	CQG	13"	REACH RoHS	Released	EAR99

**Table Of Contents**

- **Device Overview**
  - General Description
  - Features
  - Applications
  - Functional Block Diagram
- **Port Configuration and Functions**
  - Port Diagram
  - Port Functions
- **Revision History**
- **Specifications**
  - Absolute Maximum Ratings
  - Package Information
  - Recommended Operating Conditions
  - Electrical Specifications
  - Typical Performance Plots
  - Spur Tables
- **Operation**
  - Application Information
- **Mechanical Data**
  - Outline Drawing
- **Evaluation Board**
  - Evaluation Board Outline Drawing
- **Notes**

**Revision History**

Revision Code	Revision Date	Comment
-	2018-10-01	Pre-release
A	2019-02-01	Active - Full Production
B	2020-05-01	Changed cover to ceramic
C	2022-02-01	Added -1 port configuration option

**Port Configuration and Functions**

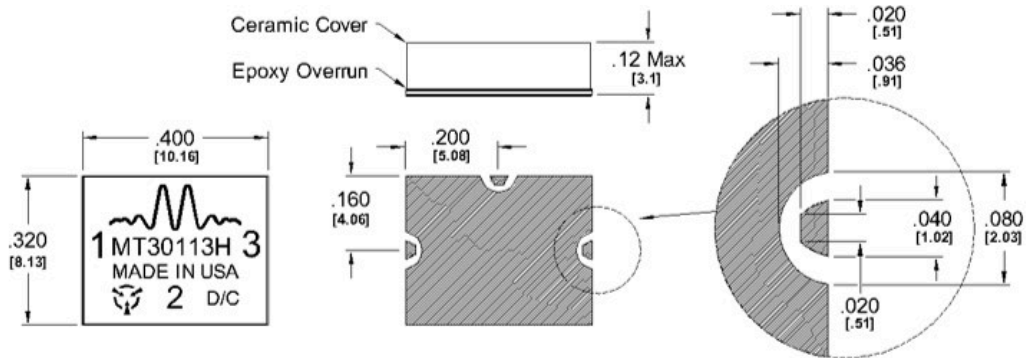

**Port Diagram**



I/O Connections & Ground Plane Finish is Gold Flash, 5 to 10 μ-inches, over Solderable Nickel, 100-200 μ-inches, over Cu.

**Port Functions**

**Configuration A**

Port	Function	Description	Equivalent Circuit for Package
Port 1	LO	Port 1 is DC short and AC matched to 50 Ω from 1.5 to 13 GHz. Blocking capacitor is optional.	
Port 2	IF	Port 2 is DC open. Blocking capacitor is optional.	
Port 3	RF	Port 3 is DC short and AC matched to 50 Ω from 1.5 to 13 GHz. Blocking capacitor is optional.	

**Configuration B**

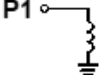
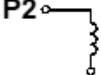
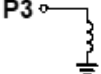
Port	Function	Description	Equivalent Circuit for Package
Port 1	RF	Port 1 is DC short and AC matched to 50 $\Omega$ from 1.5 to 13 GHz. Blocking capacitor is optional.	
Port 2	IF	Port 2 is DC open. Blocking capacitor is optional.	
Port 3	LO	Port 3 is DC short and AC matched to 50 $\Omega$ from 1.5 to 13 GHz. Blocking capacitor is optional.	

## Specifications

### Absolute Maximum Ratings

Parameter	Maximum Rating	Unit
Maximum Operating Temperature	100	°C
Maximum Storage Temperature	150	°C
Minimum Operating Temperature	-40	°C
Minimum Storage Temperature	-40	°C
RF Power Handling (RF+LO)	30	dBm

### Package Information

Parameter	Details	Rating
Dimensions	-	10.16 x 8.13 mm
Moisture Sensitivity Level	-	MSL 1

### Recommended Operating Conditions

Parameter	Min	Nominal	Max	Unit
LO Input Power	16	-	24	-

**Electrical Specifications**

Specifications guaranteed over -40 to +100°C temperature range, measured in a 50Ω system.

Parameter	Port Configuration	Test Conditions	Min	Typ	Max	Unit
Conversion Loss <sup>1</sup>	A	LO/RF=1.5-13 GHz IF=0.01-0.5 GHz LO Drive Level= 20	-	7.5	10.5	dB
Conversion Loss <sup>2</sup>	A	LO/RF=1.5-13 GHz IF=0.05-7.0 GHz	-	10	-	dB
Input IP3 <sup>3</sup>	A	LO/RF=1.5-13 GHz IF=0.01-7 GHz LO Drive Level= 16-24	-	30	-	dBm
Conversion Loss <sup>4</sup>	B	LO/RF=1.5-13 GHz IF=0.01-0.5 GHz LO Drive Level= 20	-	7.5	-	dB
Conversion Loss <sup>5</sup>	B	LO/RF=1.5-13 GHz IF=0.05-7.0 GHz	-	10	-	dB
Input IP3 <sup>6</sup>	B	LO/RF=1.5-13 GHz IF=0.01-7 GHz LO Drive Level= 16-24	-	29	-	dBm
IF Frequency Range	-	-	0.01	-	7	GHz
Isolation, LO to RF	-	-	-	40	-	dB
LO Frequency Range	-	-	1.5	-	13	GHz
RF Frequency Range	-	-	1.5	-	13	GHz

[1][2][4][5] Unless otherwise specified, Conversion Loss and Spurious data is measured with a 100 MHz fixed IF.

[3][6] The typical value is for a +20 dBm Sine-Wave LO. IP3 is dependent on LO drive and waveform. See plots and data sheet notes for more details.

**Typical Performance Plots**

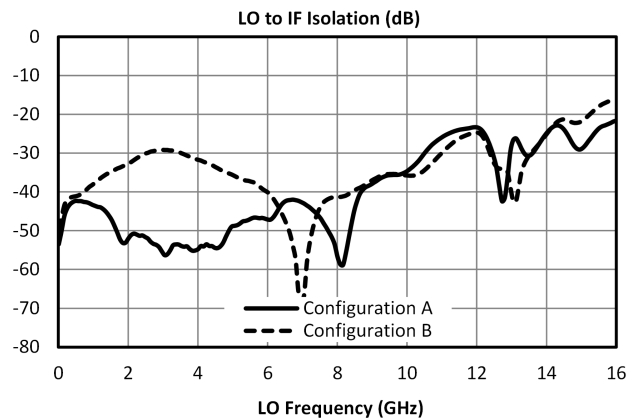
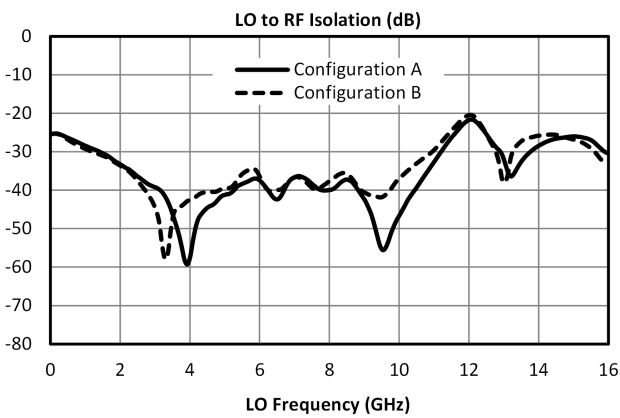
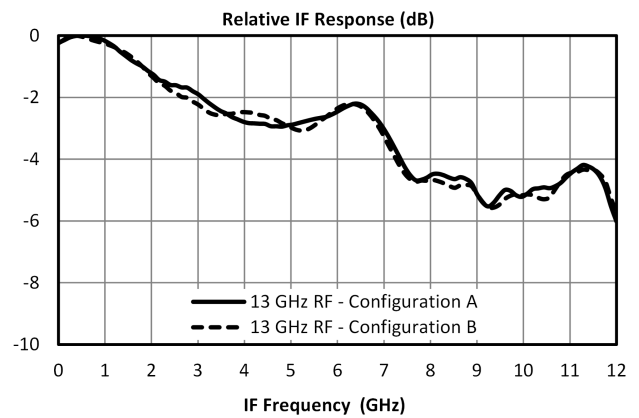
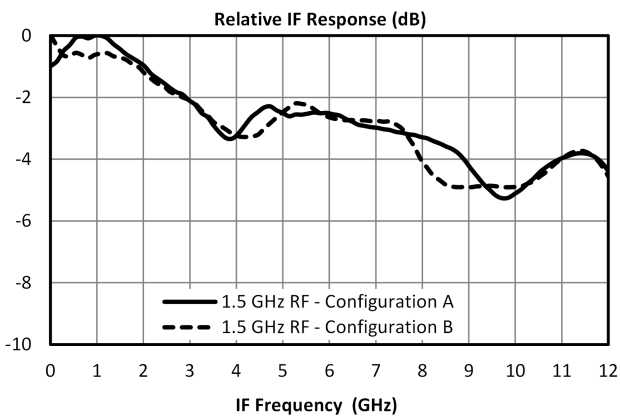
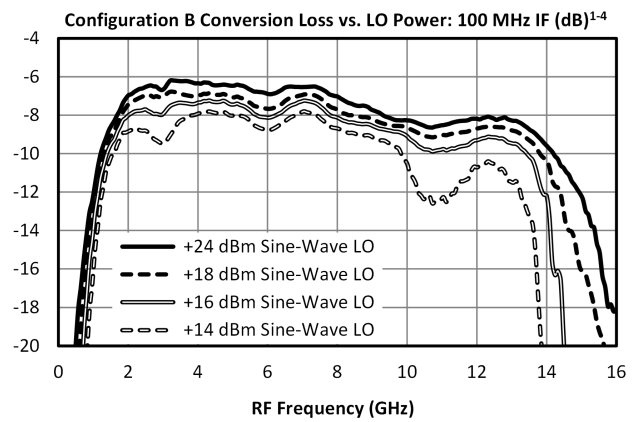
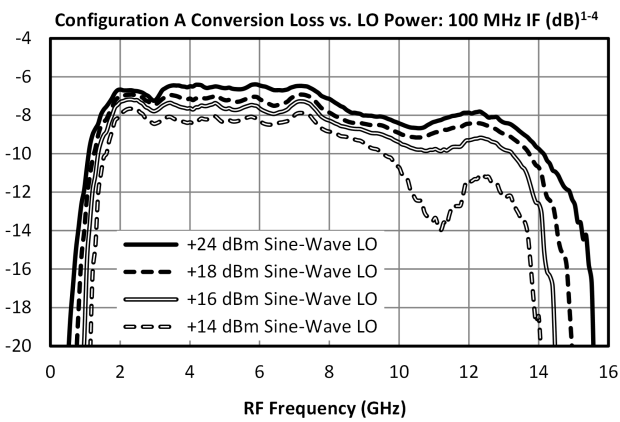
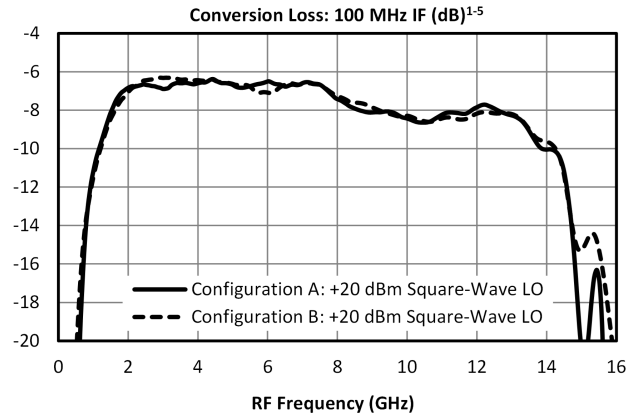
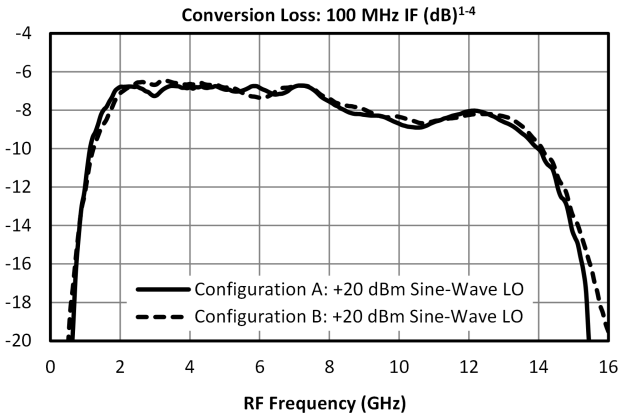

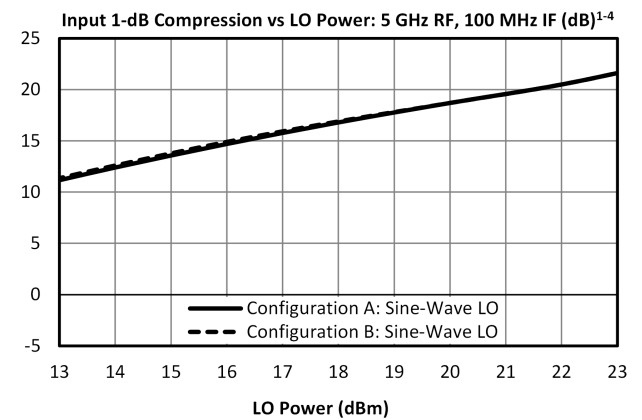
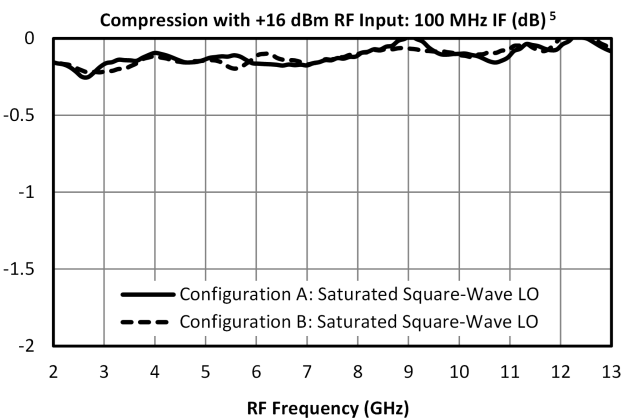
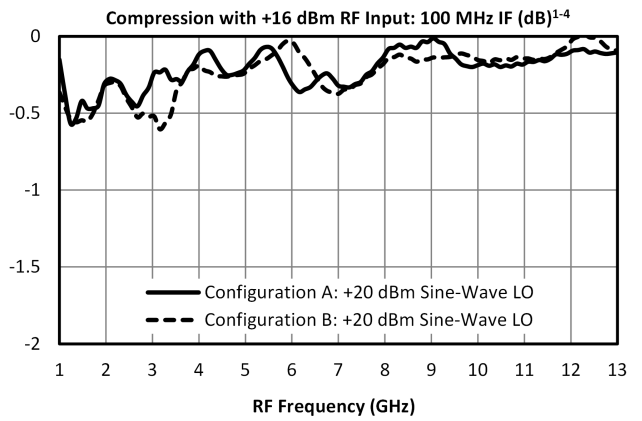
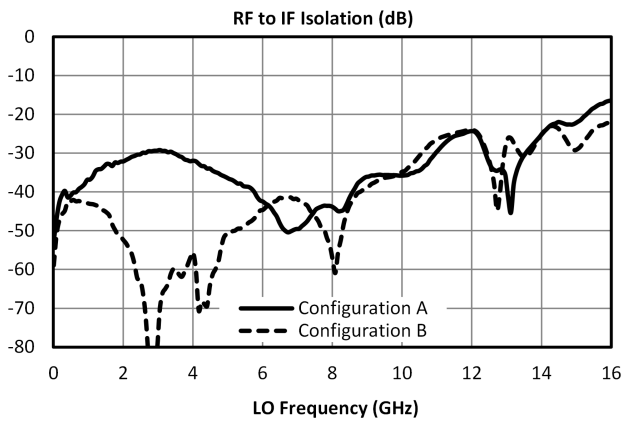
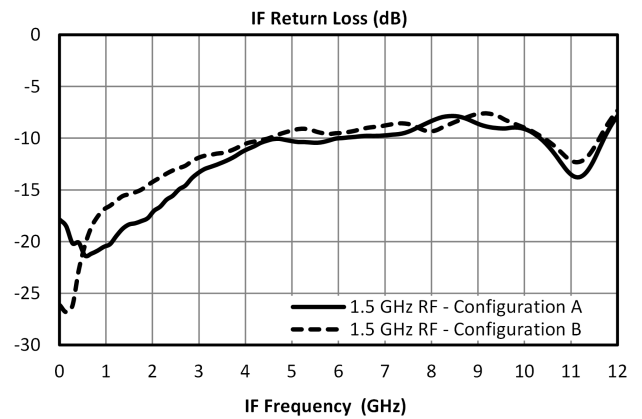
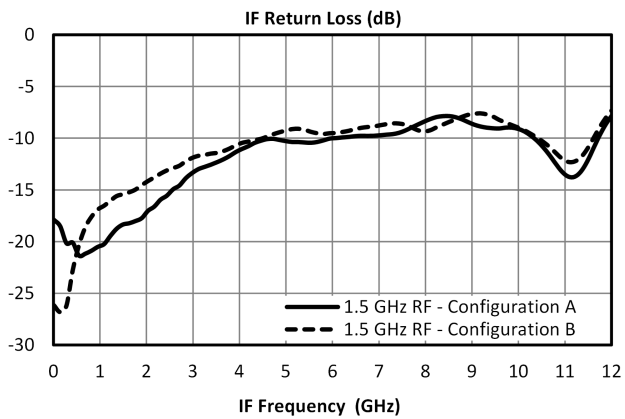
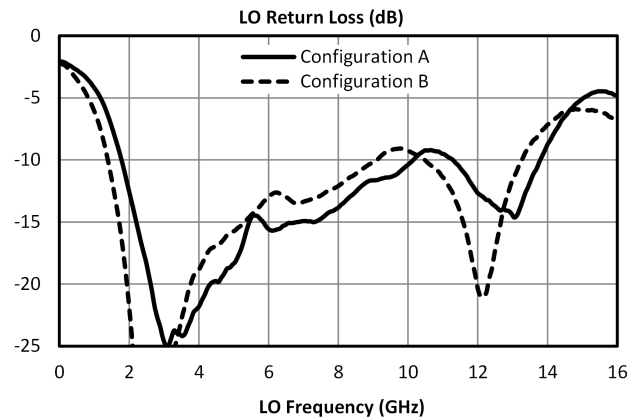
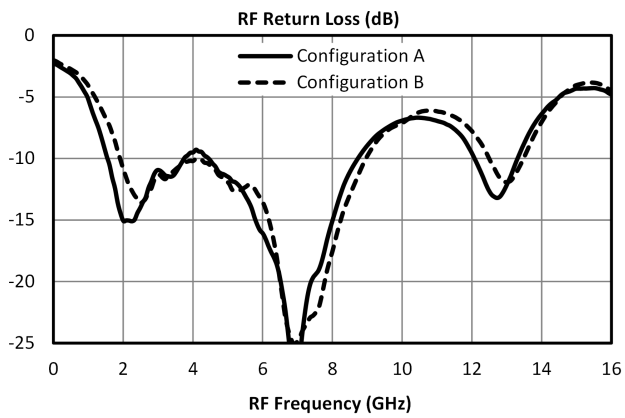

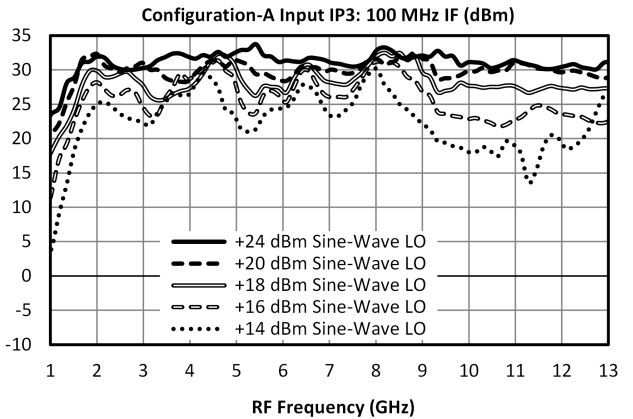
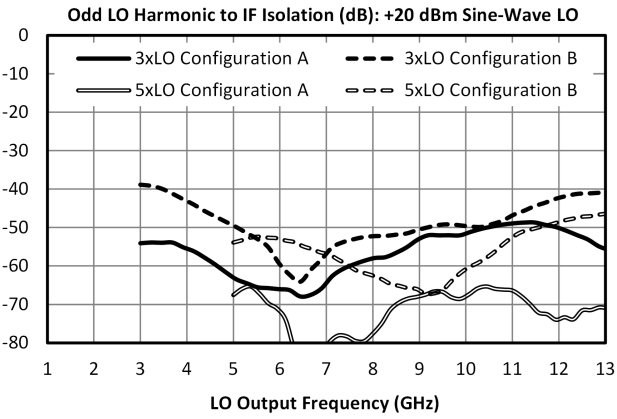
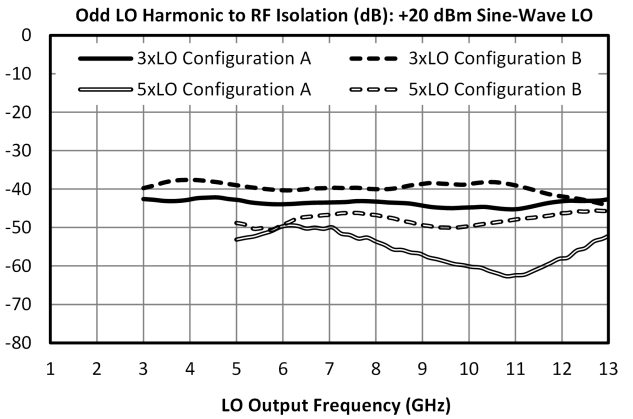
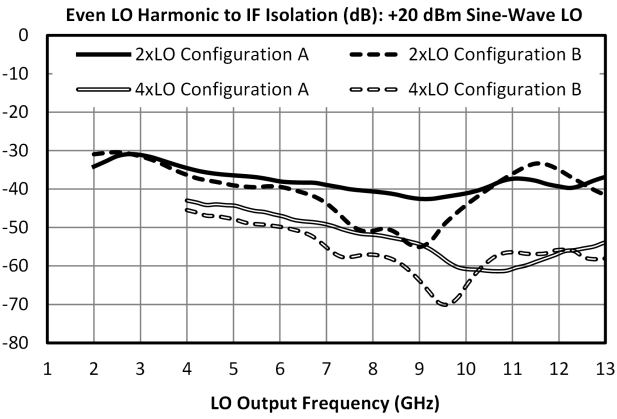
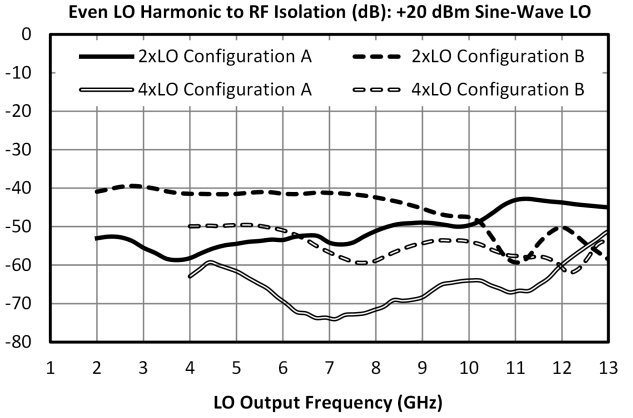
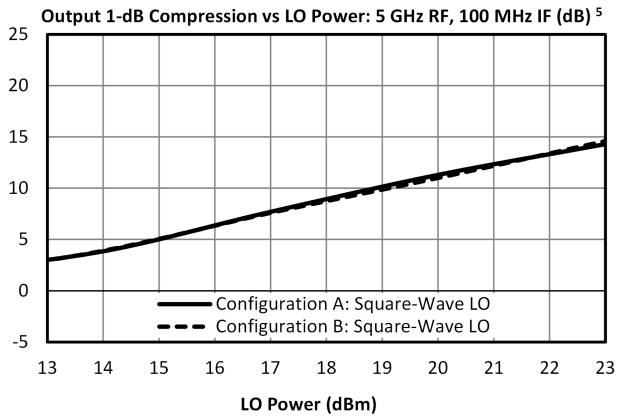
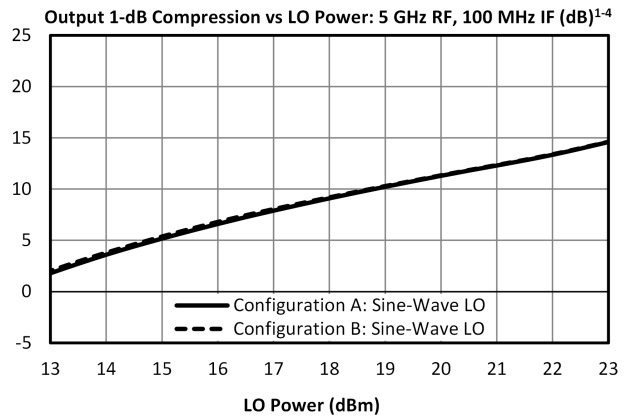
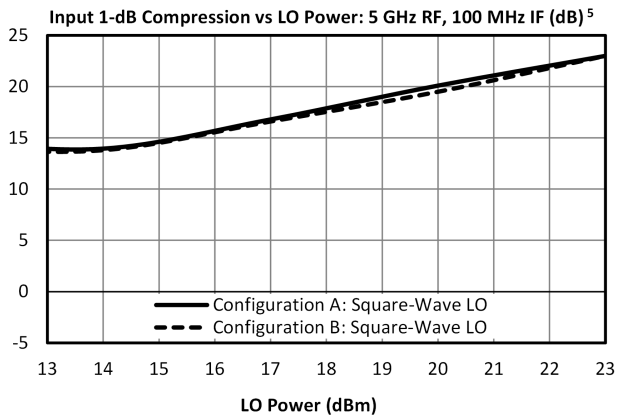

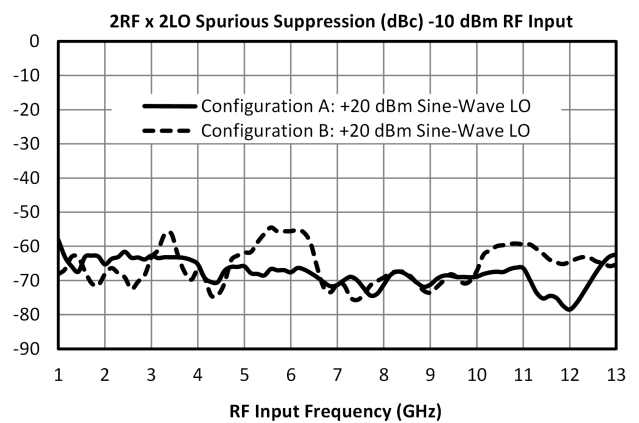
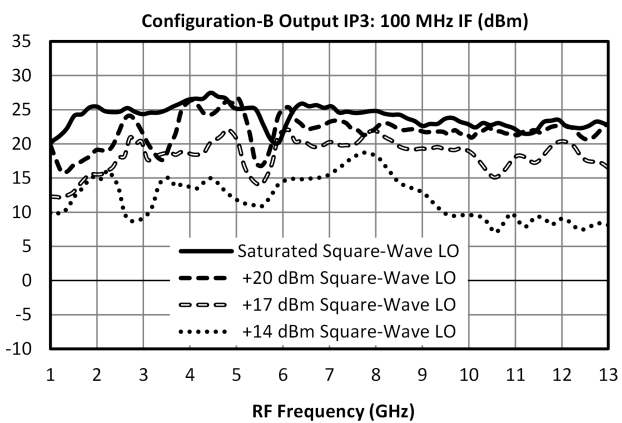
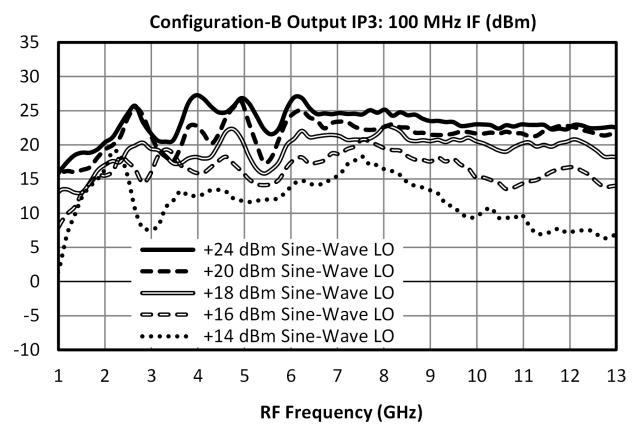
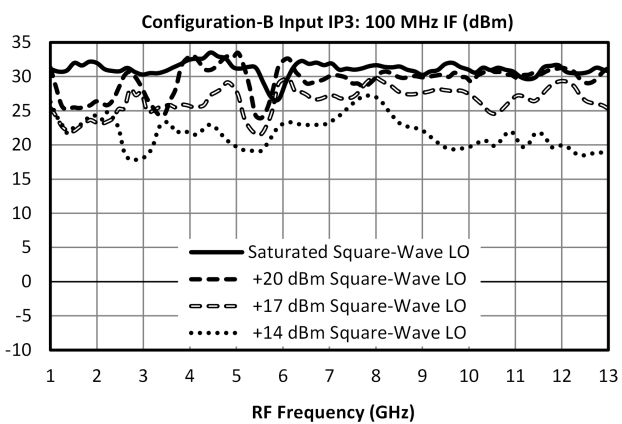
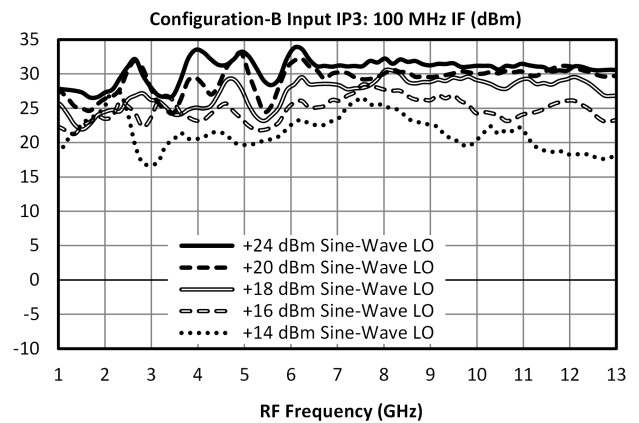
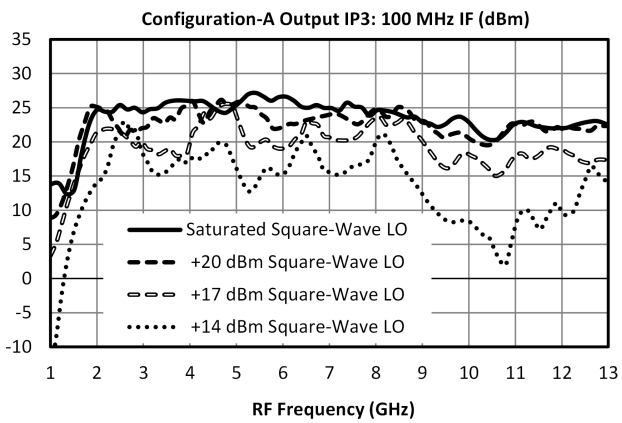
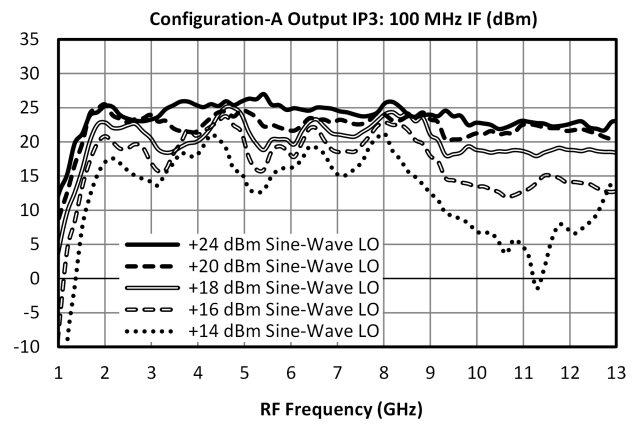
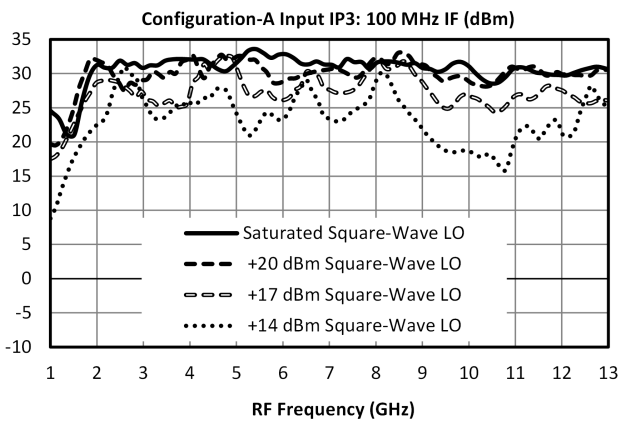

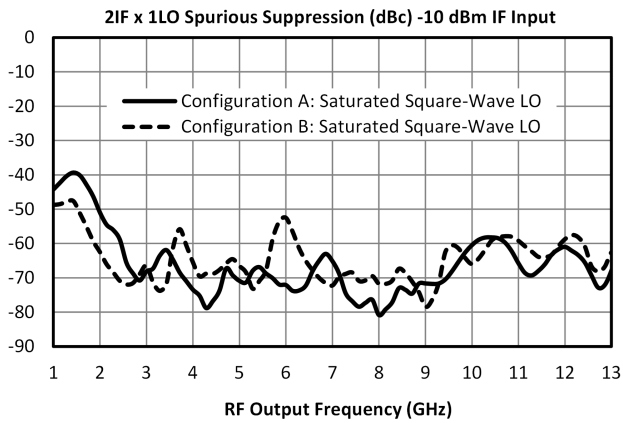
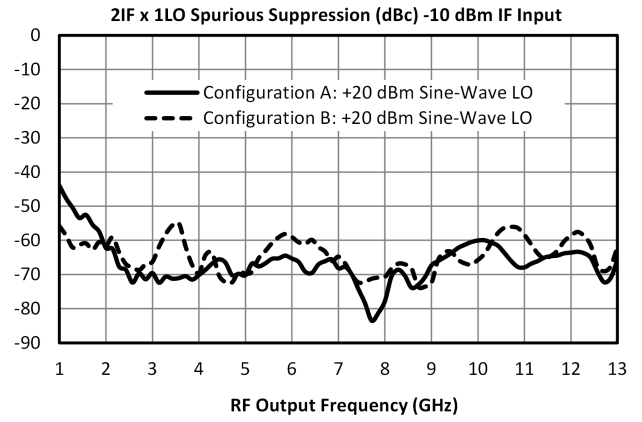
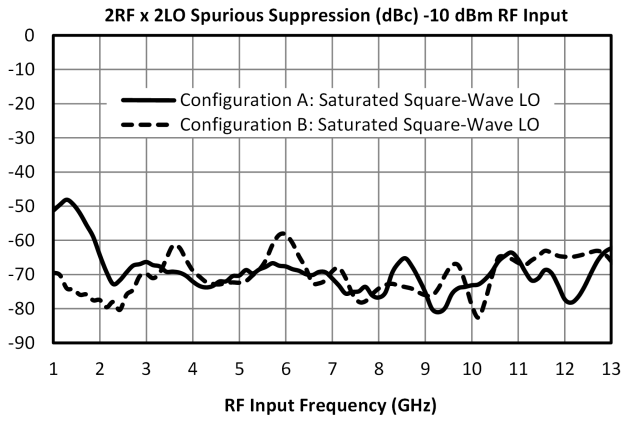

**Spur Table**

**Downconversion Spurious Suppression**

Spurious data is taken by selecting RF and LO frequencies (+mLO+nRF) within the RF/LO bands, to create a spurious output within the IF band. The mixer is swept across the full spurious band and the mean is calculated. The numbers shown in the table below are for a -10 dBm RF input. Spurious suppression is scaled for different RF power levels by (n-1), where “n” is the RF spur order. For example, the 2RFx2LO spur is 68 dBc for the A configuration for a -10 dBm input with a sine-wave LO, so a -20 dBm RF input creates a spur that is (2-1) x (-10 dB) dB lower, or 78dBc.

**Typical Downconversion Spurious Suppression (dBc): A Configuration (B Configuration), Sine Wave LO <sup>6</sup>**

<b>-10 dBm RF Input</b>	<b>0xLO</b>	<b>1xLO</b>	<b>2xLO</b>	<b>3xLO</b>	<b>4xLO</b>	<b>5xLO</b>
1xRF	30 (37)	Reference	42 (41)	19 (18)	42 (46)	25 (33)
2xRF	61 (66)	70 (69)	68 (66)	74 (67)	67 (62)	72 (64)
3xRF	112 (113)	89 (88)	99 (102)	88 (87)	100 (100)	81 (82)
4xRF	122 (131)	125 (128)	122 (122)	127 (126)	127 (123)	131 (126)
5xRF	158 (164)	145 (149)	149 (149)	142 (144)	151 (151)	146 (144)

**Typical Downconversion Spurious Suppression (dBc): A Configuration (B Configuration), Square Wave LO <sup>6</sup>**

<b>-10 dBm RF Input</b>	<b>0xLO</b>	<b>1xLO</b>	<b>2xLO</b>	<b>3xLO</b>	<b>4xLO</b>	<b>5xLO</b>
1xRF	32 (39)	Reference	30 (29)	12 (11)	27 (27)	19 (18)
2xRF	62 (68)	72 (69)	70 (70)	71 (76)	65 (64)	74 (73)
3xRF	113 (113)	90 (89)	103 (105)	92 (92)	100 (107)	93 (95)
4xRF	132 (132)	130 (134)	129 (127)	135 (135)	130 (133)	132 (136)
5xRF	172 (174)	148 (152)	151 (151)	150 (151)	152 (153)	150 (155)

**Upconversion Spurious Suppression**

Spurious data is taken by mixing an input within the IF band, with LO frequencies (+mLO+nIF), to create a spurious output within the RF output band. The mixer is swept across the full spurious output band and the mean is calculated. The numbers shown in the table below are for a -10 dBm IF input. Spurious suppression is scaled for different IF input power levels by (n-1), where “n” is the IF spur order. For example, the 2IFx1LO spur is typically 67 dBc for the A configuration for a -10 dBm input with a sine-wave LO, so a -20 dBm IF input creates a spur that is (2-1) x (-10 dB) dB lower, or 77 dBc.

**Typical Upconversion Spurious Suppression (dBc): A Configuration (B Configuration), Sine Wave LO <sup>6</sup>**

<b>-10 dBm IF Input</b>	<b>0xLO</b>	<b>1xLO</b>	<b>2xLO</b>	<b>3xLO</b>	<b>4xLO</b>	<b>5xLO</b>
1xIF	27 (39)	Reference	38 (40)	17 (16)	37 (43)	26 (22)
2xIF	72 (68)	67 (64)	63 (59)	66 (58)	69 (58)	67 (59)
3xIF	112 (112)	80 (78)	91 (93)	76 (72)	87 (93)	74 (71)
4xIF	124 (130)	122 (118)	119 (113)	118 (110)	123 (106)	114 (108)
5xIF	153 (154)	139 (139)	141 (144)	128 (127)	137 (134)	117 (114)

**Typical Upconversion Spurious Suppression (dBc): A Configuration (B Configuration), Square Wave LO <sup>6</sup>**

<b>-10 dBm IF Input</b>	0xLO	1xLO	2xLO	3xLO	4xLO	5xLO
1xIF	28 (38)	Reference	30 (32)	12 (11)	26 (27)	21 (17)
2xIF	81 (69)	67 (65)	64 (63)	62 (65)	61 (63)	53 (62)
3xIF	113 (112)	83 (83)	94 (95)	79 (80)	89 (90)	77 (78)
4xIF	133 (137)	128 (125)	120 (120)	117 (122)	114 (118)	104 (119)
5xIF	154 (154)	148 (149)	144 (146)	138 (141)	137 (141)	125 (129)

**Application Information**

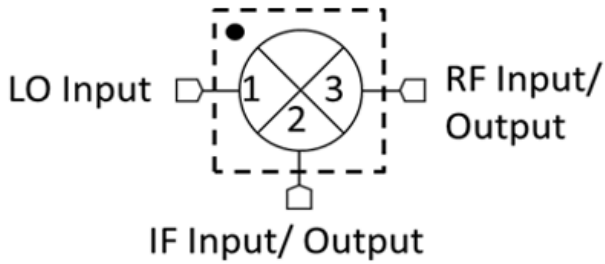

**Configuration A**

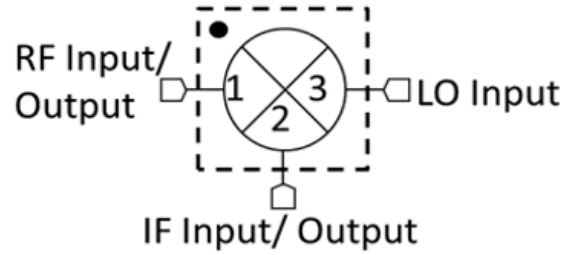

**Configuration B**

Configuration A/B refer to the same part number (MT3-0113HCQG) used in one of two different ways for optimal spurious performance. For the lowest conversion loss, use the mixer in Configuration A (port 1 as the LO input, port 3 as the RF input or output). If you need to use a lower LO drive, use the mixer in Configuration B (port 1 as the RF input or output, port 3 as the LO input). For optimal spurious suppression, experimentation or simulation is required to choose between Configuration A and B.

**Mechanical Data**

**Outline Drawing**

Download : [Outline 3D Drawing](#) | [Outline 3D STP](#)

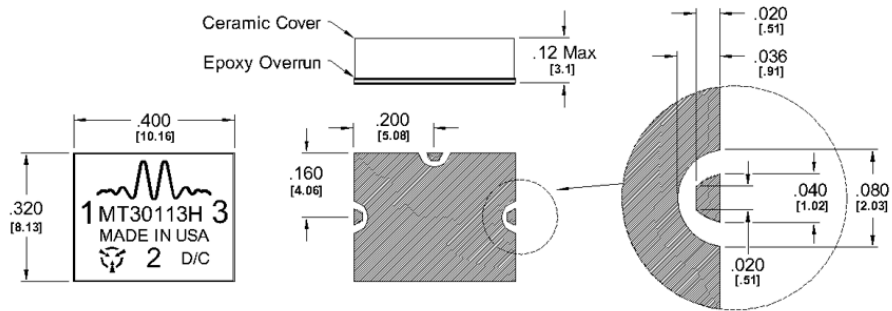

I/O Connections & Ground Plane Finish is Gold Flash, 5 to 10  $\mu$ -inches, over Solderable Nickel, 100-200  $\mu$ -inches, over Cu.

**Evaluation Board - Outline Drawing**

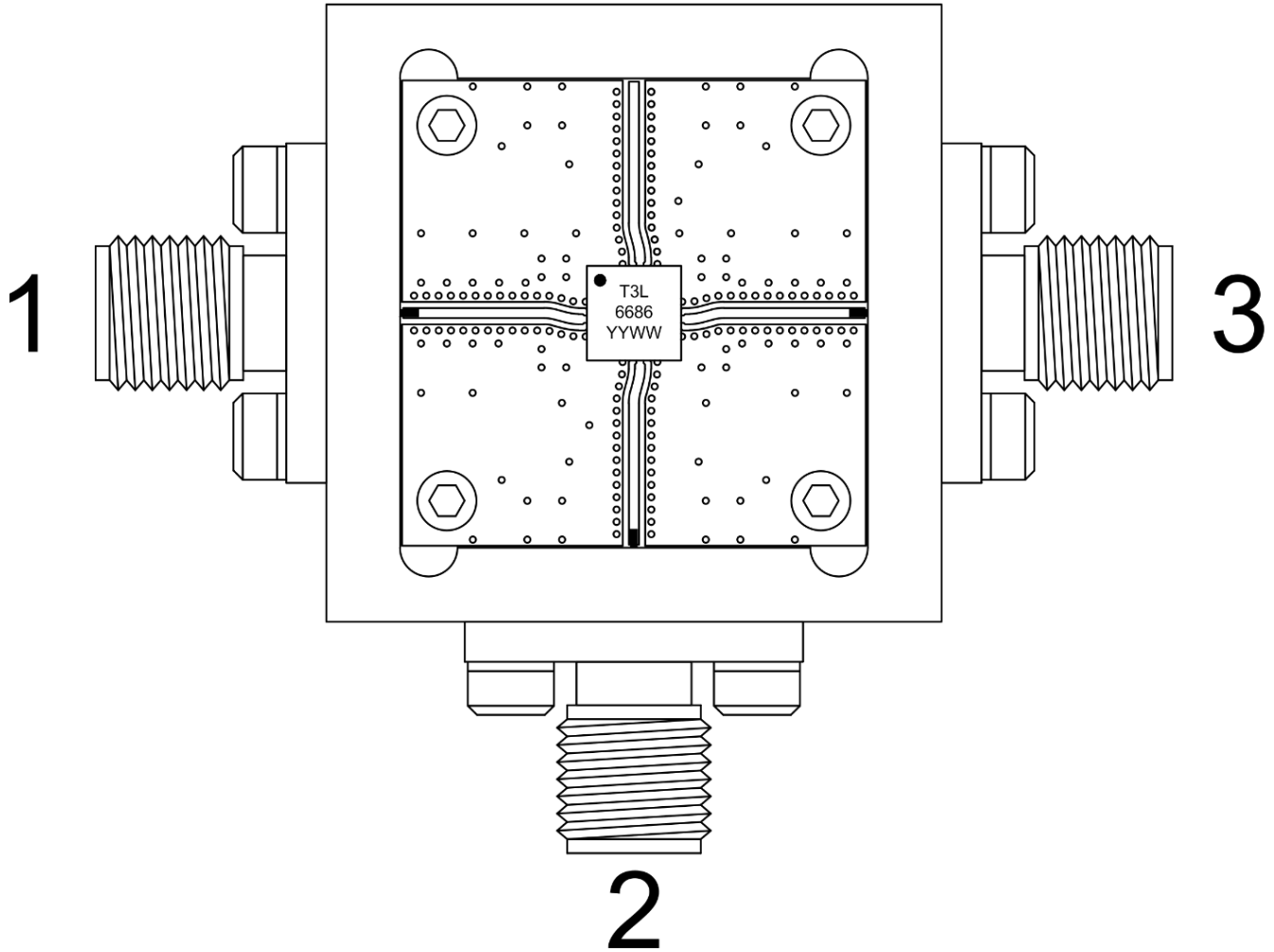

## Notes

### DATA SHEET NOTES:

1. Mixer Conversion Loss Plot IF frequency is 100 MHz unless otherwise specified.2
2. Mixer Noise Figure typically measures within 0.5 dB of conversion loss for IF frequencies greater than 5 MHz.3
3. Conversion Loss typically degrades less than 0.5 dB at +100°C and improves less than 0.5 dB at -55°C.
4. Unless otherwise specified, sine-wave data is taken with +20 dBm LO drive.
5. The square-wave LO is generated using an ADM-0012-5931SM pre-amplifier and an ADM-0026-5929SM output amplifier. The two amplifiers are biased with +7V, -0.25V. When specified, square-wave output power is the total of the fundamental plus harmonics.  
Unspecified square-wave LO (unspecified output power) is generated by saturating the amplifier chain with a +12 dBm input.
6. Specifications are subject to change without notice. Contact Marki Microwave for the most recent specifications and data sheets.
7. Catalog mixer circuits are continually improved. Configuration control requires custom mixer model numbers and specifications.
8. Environmental specifications are currently under evaluation. Contact support for more information.

## DISCLAIMER

MARKI MICROWAVE, INC., ("MARKI") PROVIDES TECHNICAL SPECIFICATIONS AND DATA (INCLUDING DATASHEETS), APPLICATION OR OTHER DESIGN ADVICE, WEB TOOLS, AND OTHER INFORMATION AND RESOURCES "AS IS" AND WITH ALL FAULTS. MARKI DISCLAIMS ALL WARRANTIES, EXPRESS OR IMPLIED, INCLUDING, WITHOUT LIMITATION, ANY IMPLIED WARRANTIES OF MERCHANTABILITY, FITNESS FOR A PARTICULAR PURPOSE, OR NON-INFRINGEMENT. These resources are intended for developers skilled in the art designing with Marki products. You are solely responsible for (1) selecting the appropriate products for your application, (2) designing, validating, and testing your application, and (3) ensuring your application meets applicable standards and other requirements. Marki makes no guarantee regarding the suitability of its products for any particular purpose, nor does Marki assume any liability whatsoever arising out of your use or application of any Marki product.

Marki grants you permission to use these resources only for development of an application that uses Marki products. Other reproduction or use of these resources is strictly prohibited. No license is granted to any other Marki intellectual property or to any third-party intellectual property. Marki reserves the right to make changes to the product(s) or information contained herein without notice.

MARKI MICROWAVE and T3 MIXER are trademarks or registered trademarks of Marki Microwave, Inc. All other trademarks used are the property of their respective owners.

© 2018 - 2020, 2022, Marki Microwave, Inc