

MM1-0212SS

GaAs MMIC Double Balanced Mixer

DEVICE OVERVIEW

General Description

MM1-0212S is a highly linear GaAs MMIC double balanced mixer. MM1-0212S is a low frequency, high linearity S band mixer that works well as both an up and down converter to through X band. This mixer offers low conversion loss and high LO to RF isolations at the nominal LO drive. The sister MM1-0212H and MM1-0212L are recommended for applications which need LO operation at lower powers. The MM1-0212S is available as both wire bondable die and as connectorized modules.

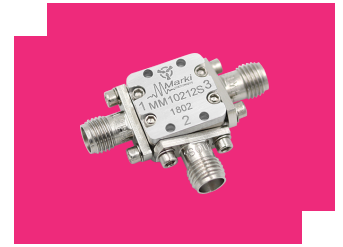

Features

- High nominal +26 dBm IIP3
- Low cost X band mixer

Applications

- Test and Measurement Equipment

Functional Block Diagram

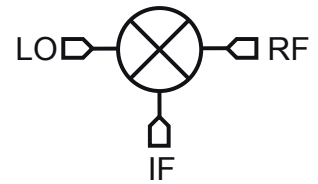

Part Ordering Options

Part Number	Description	Package	Connectors	Green Status	Product Lifecycle	Export Classification
MM1-0212SS	GaAs MMIC Double Balanced Mixer	S	<u>Standard</u>	REACH RoHS	Released	EAR99

Table Of Contents

- **Device Overview**
 - General Description
 - Features
 - Applications
 - Functional Block Diagram
- **Port Configuration and Functions**
 - Port Diagram
 - Port Functions
- **Revision History**
- **Specifications**
 - Absolute Maximum Ratings
 - Package Information
 - Recommended Operating Conditions
 - Sequencing Requirements
 - Electrical Specifications
 - Typical Performance Plots
 - Typical Performance Plots: IP3
 - Typical Performance Plots: LO Harmonic Isolation
 - Spur Tables
- **Mechanical Data**
 - Outline Drawing

Revision History

Revision Code	Revision Date	Comment
-	2018-01-01	- January 2018 Datasheet Initial Release
A	2019-01-01	Added max power/current spec, ESD rating

Port Configuration and Functions

Port Diagram

The MM1-0212S has the input and output ports given in Port Functions. The MM1-0212S can be used in either an up or down conversion. For configuration A, input the LO into port 1, use port 3 for the RF, and port 2 for the IF. For configuration B, input the LO into port 3, use port 1 for the RF, and port 2 for the IF.

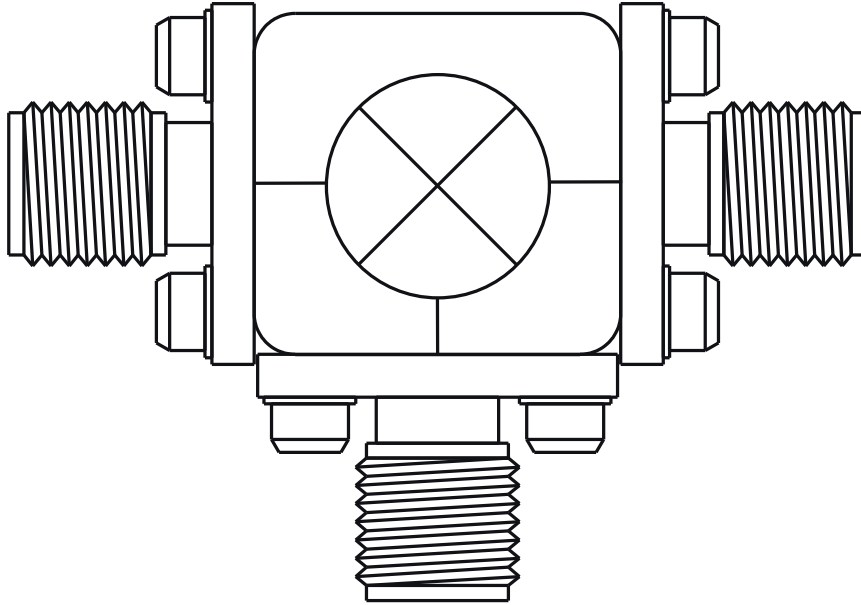

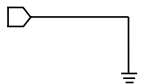
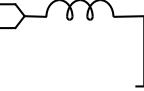
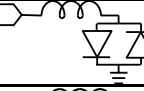
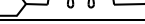

Port Functions

Configuration A

Port	Function	Connector Type	Description	Equivalent Circuit for Package
GND	Ground	-	S package ground provided through metal housing and outer coax conductor.	
Port 1	LO	SMAF	Port 1 is DC short for the CH and S packages.	
Port 2	IF	SMAF	Port 2 is diode connected for the CH and S package.	
Port 3	RF	SMAF	Port 3 is DC open for the CH and S packages.	

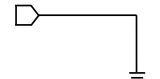
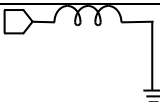
Configuration B

Port	Function	Connector Type	Description	Equivalent Circuit for Package
GND	Ground	-	S package ground provided through metal housing and outer coax conductor.	
Port 1	RF	SMAF	Port 1 is DC short for the CH and S packages.	
Port 2	IF	SMAF	Port 2 is diode connected for the CH and S package.	
Port 3	LO	SMAF	Port 3 is DC open for the CH and S packages.	

Specifications

Absolute Maximum Ratings

The Absolute Maximum Ratings indicate limits beyond which damage may occur to the device. If these limits are exceeded, the device may be inoperable or have a reduced lifetime.

Parameter	Maximum Rating	Unit
Maximum Operating Temperature	100	°C
Maximum Storage Temperature	125	°C
Minimum Operating Temperature	-55	°C
Minimum Storage Temperature	-65	°C
Port 1 DC Current	30	mA
Port 2 DC Current	30	mA
Power Handling, at any Port	30	dBm

Package Information

Parameter	Details	Rating
ESD	250 to < 500 Volts	HBM Class 1A
Weight	Package name: S	10g
Dimensions	-	14.22 x 13.21 mm

Recommended Operating Conditions

The Recommended Operating Conditions indicate the limits, inside which the device should be operated, to guarantee the performance given in Electrical Specifications. Operating outside these limits may not necessarily cause damage to the device, but the performance may degrade outside the limits of the electrical specifications. For limits, above which damage may occur, see Absolute Maximum Ratings.

Parameter	Min	Nominal	Max	Unit
LO Input Power	17	-	23	dBm
Ambient Temperature	-55	25	100	°C

Sequencing Requirements

There is no requirement to apply power to the ports in a specific order. However, it is recommended to provide a 50Ω termination to each port before applying power. This is a passive diode mixer that requires no DC bias.

Electrical Specifications

The electrical specifications apply at TA=+25°C in a 50Ω system. Typical data shown is for the connectorized S package mixer used in the forward direction with a +20 dBm sine wave input. Min and Max limits apply only to our connectorized units and are guaranteed at TA=+25°C. All bare die are 100% DC tested and visually inspected.

Parameter	Port Configuration	Test Conditions	Min	Typ	Max	Unit
Conversion Loss ¹	A	RF/LO = 2 - 12 GHz I = 0.2 - 3 GHz	-	9	-	dB
Conversion Loss ²	A	RF/LO = 2 - 12 GHz I = DC - 0.2 GHz	-	8.5	11.5	dB
Input 1 dB Gain Compression Point (P1dB)	A	-	-	16	-	dBm
Input IP3	A	RF/LO = 2 - 12 GHz I = DC - 0.2 GHz	-	26	-	dBm
Conversion Loss ³	B	RF/LO = 2 - 12 GHz I = 0.2 - 3 GHz	-	11.5	-	dBm
Conversion Loss ⁴	B	RF/LO = 2 - 12 GHz I = DC - 0.2 GHz	-	10.5	14	dB
Input 1 dB Gain Compression Point (P1dB)	B	-	-	18	-	dBm
Input IP3	B	RF/LO = 2 - 12 GHz I = DC - 0.2 GHz	-	29	-	dBm
IF Frequency Range	-	-	0	-	3	GHz
Isolation, LO to IF	-	IF/LO = 2 - 12 GHz	-	49	-	dB
Isolation, LO to RF	-	RF/LO = 2 - 12 GHz	-	47	-	dB
Isolation, RF to IF	-	RF/IF = 2 - 12 GHz	-	39	-	dB
LO Frequency Range	-	-	2	-	12	GHz
Noise Figure ⁵	-	RF/LO = 2 - 12 GHz I = DC - 0.2 GHz	-	9	-	dB
RF Frequency Range	-	-	2	-	12	GHz

[1][2][3][4] Measured as a down converter to a fixed 91MHz IF.

[5] Mixer Noise Figure typically measures within 0.5 dB of conversion loss for IF frequencies greater than 5 MHz.

Typical Performance Plots

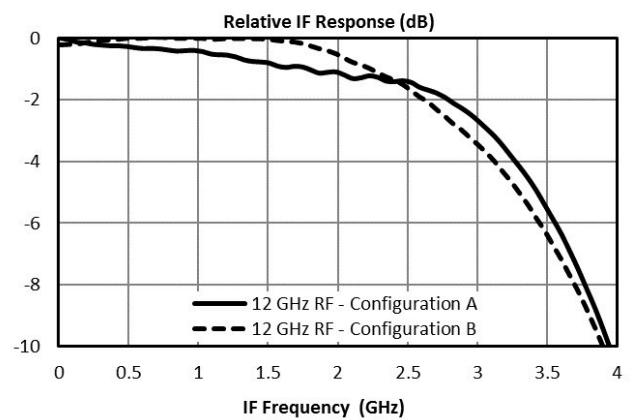
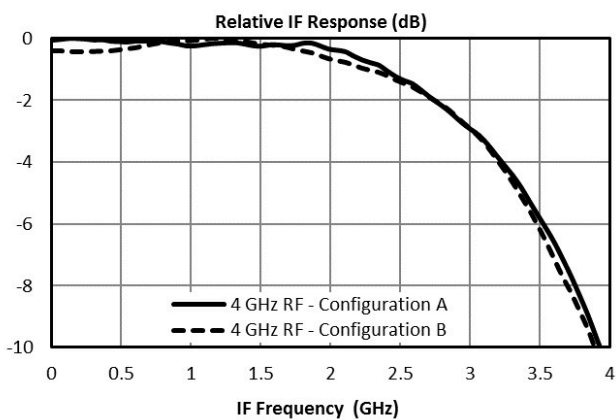
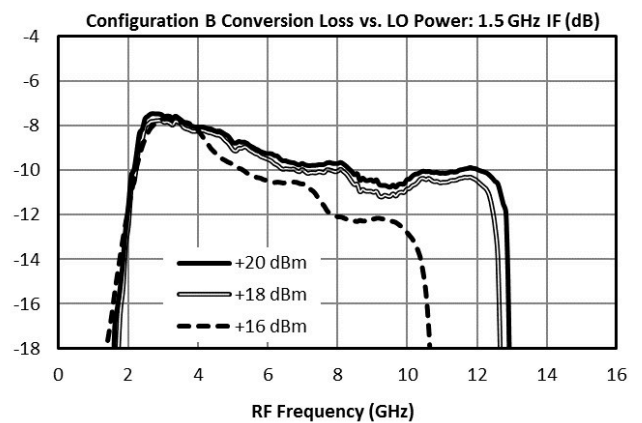
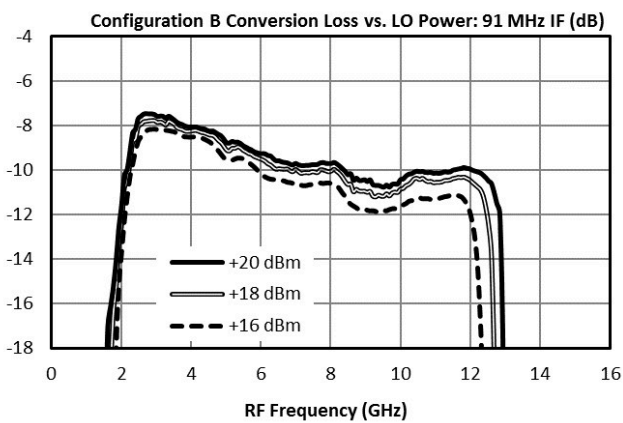
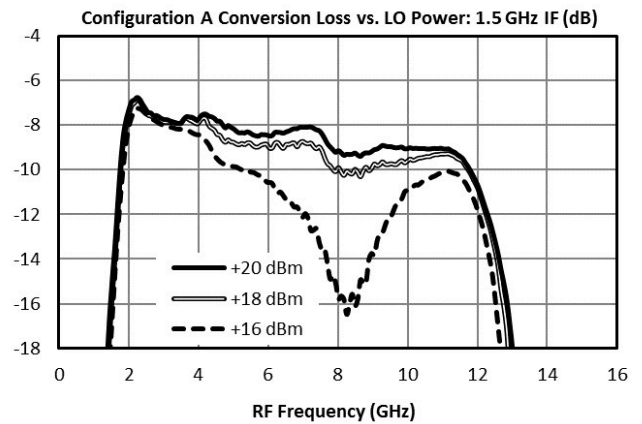
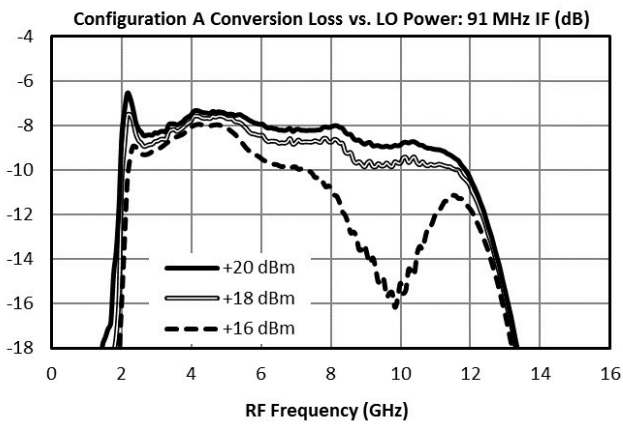
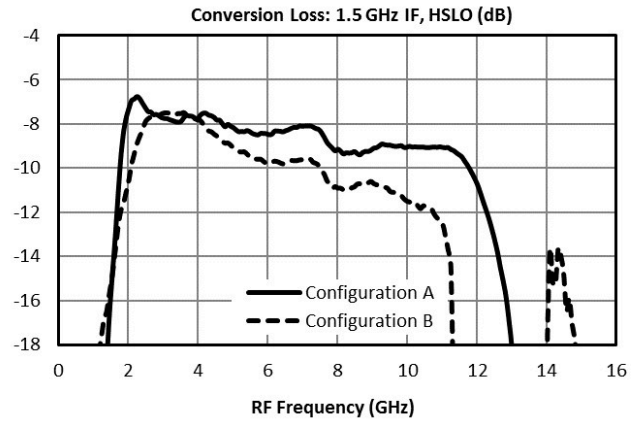
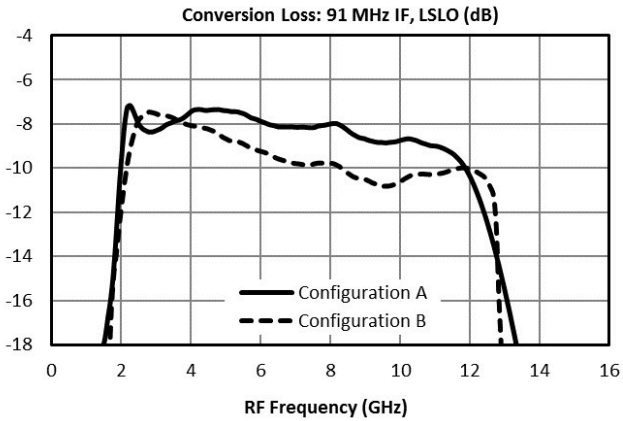

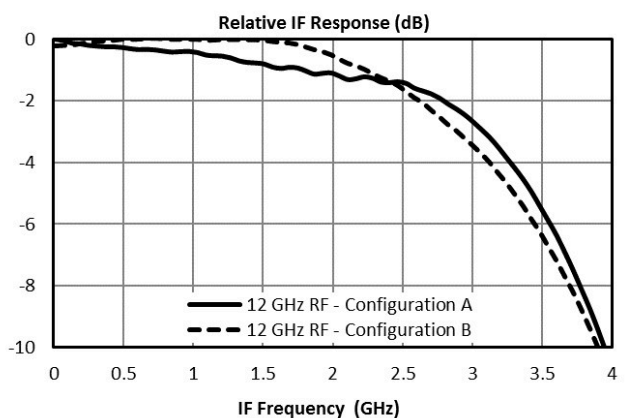
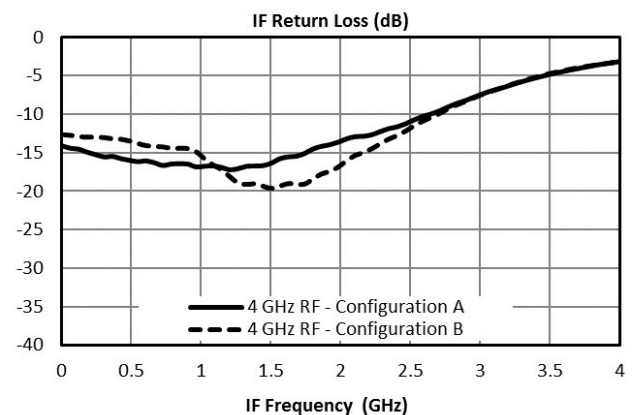
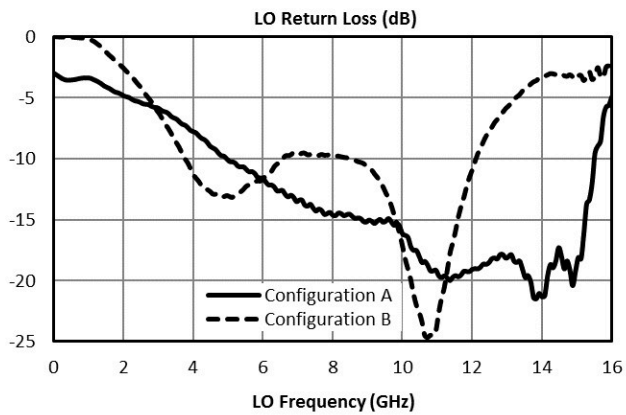
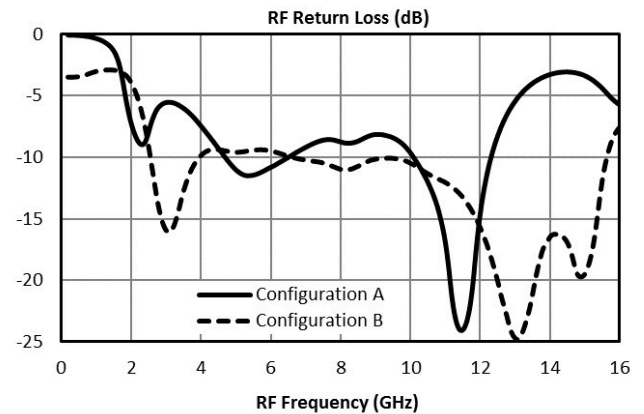
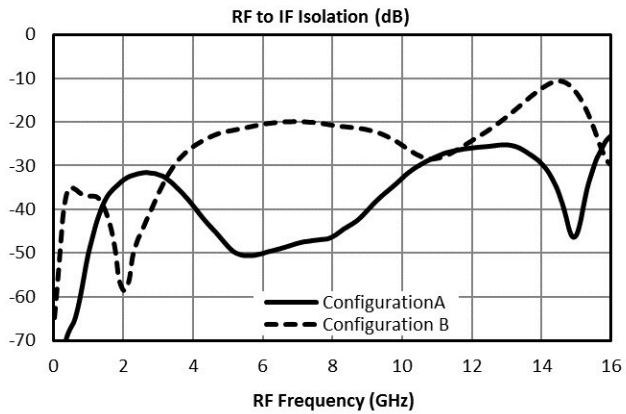
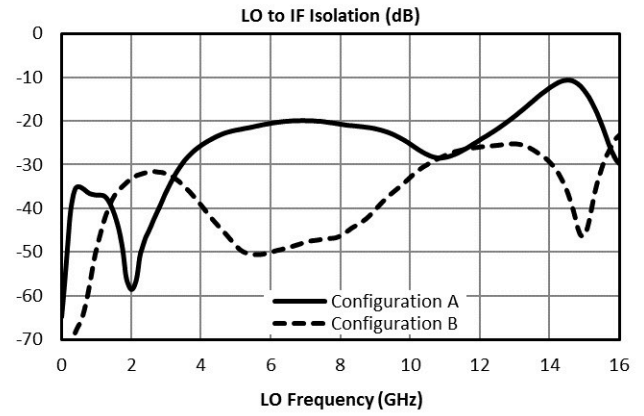
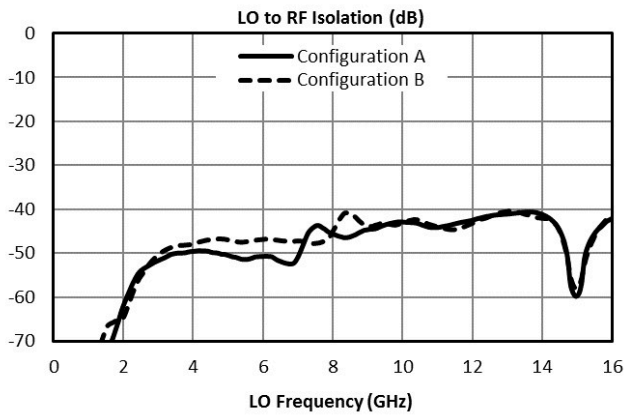

Typical Performance Plots: IP3

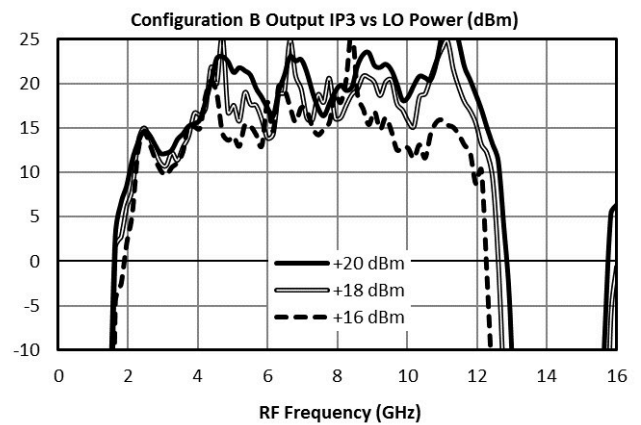
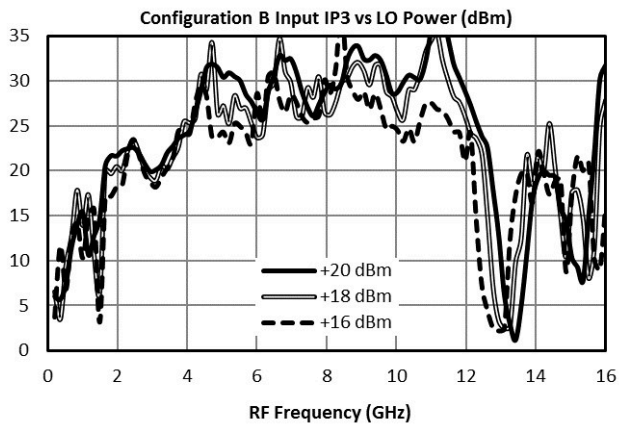
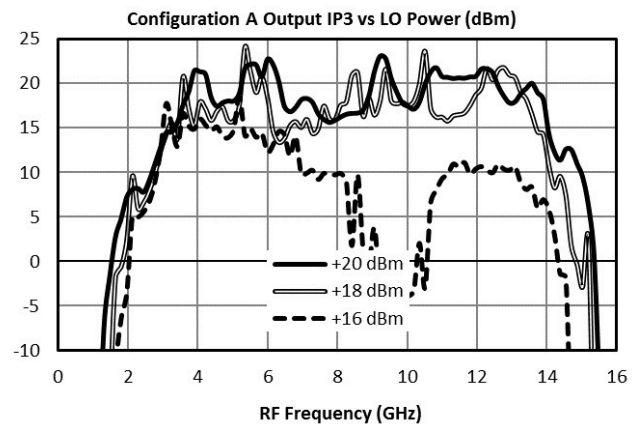
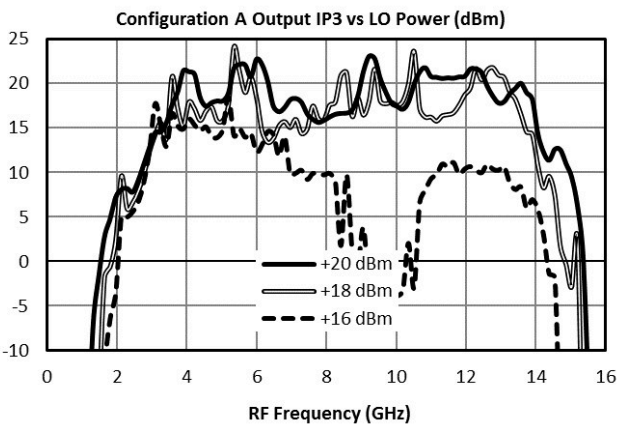
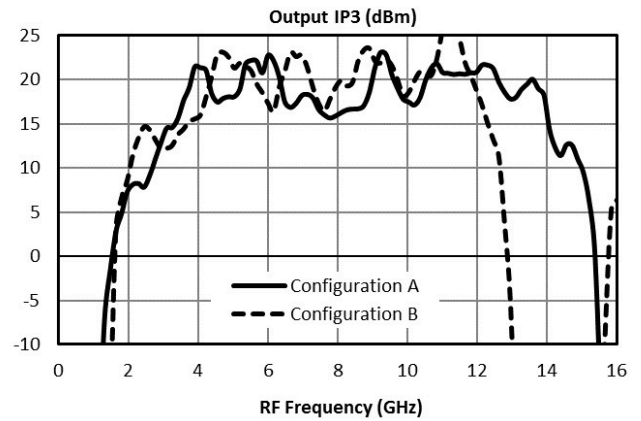
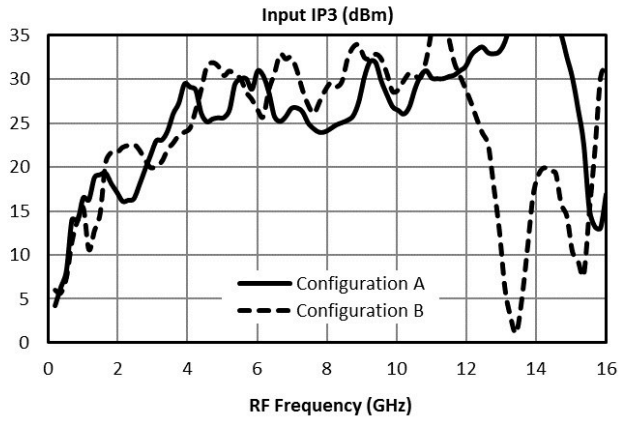

Typical Performance Plots: LO Harmonic Isolation

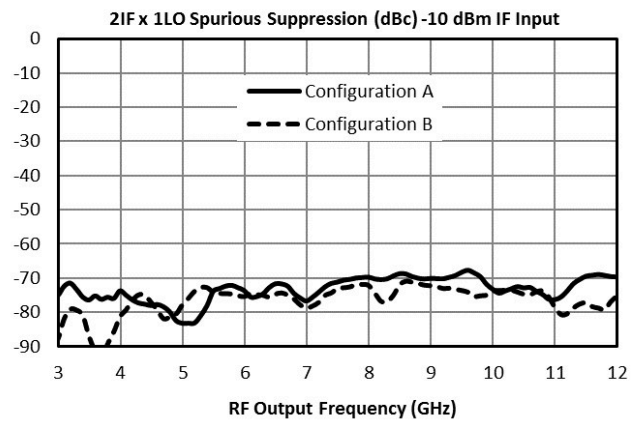
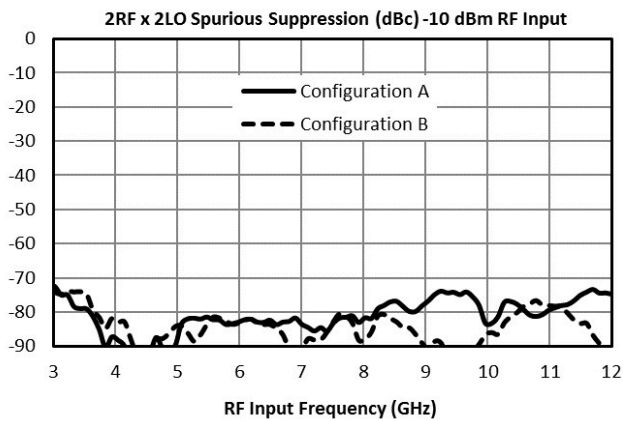
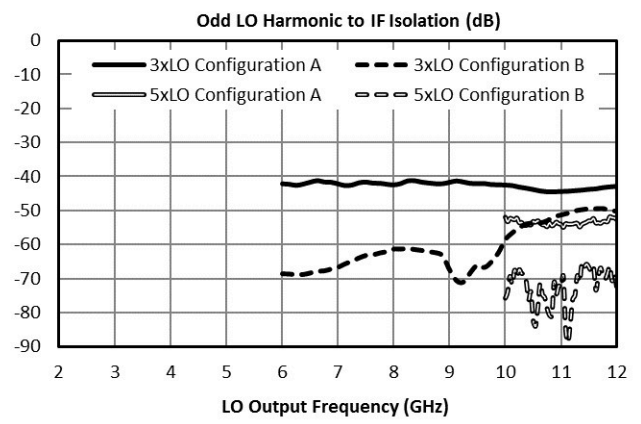
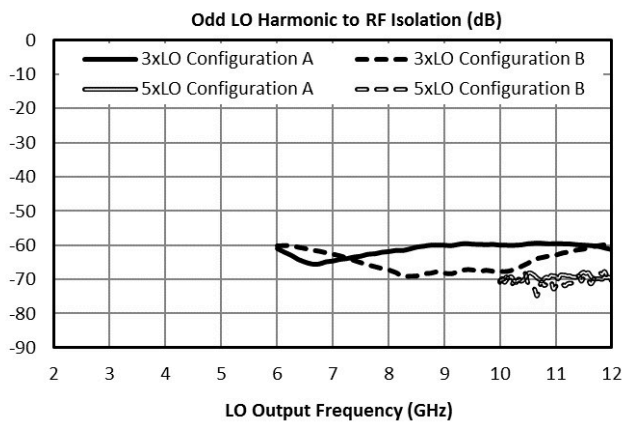
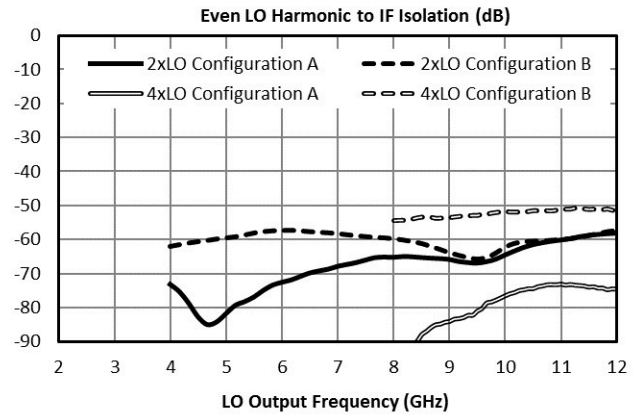
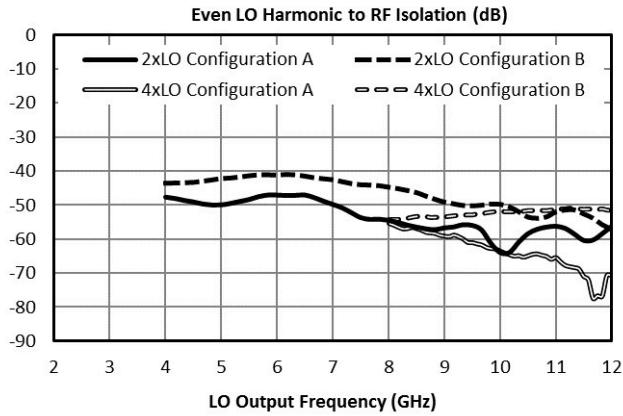

Spur Table

Typical Spurious Performance: Down-Conversion

Typical spurious data is provided by selecting RF and LO frequencies ($\pm m \cdot LO \pm n \cdot RF$) within the RF/LO bands, to create a spurious output within the IF band. The mixer is swept across the full spurious band and the mean is calculated. The numbers shown in the table below are for a -10 dBm RF input. Spurious suppression is scaled for different RF power levels by (n-1), where “n” is the RF spur order. For example, the 2RF x 2LO spur is 80 dBc for a -10 dBm input, so a -20 dBm RF input creates a spur that is (2-1) x (-10 dB) lower, or 90 dBc. Data is shown for the frequency plan in 3.6 Typical Performance.

Typical Down-conversion spurious suppression (dBc): Config A (B)

-10 dBm RF Input	0xLO	1xLO	2xLO	3xLO	4xLO	5xLO
1xRF	30 (16)	Reference	33 (32)	11 (13)	44 (38)	24 (24)
2xRF	74 (72)	63 (61)	80 (84)	73 (71)	70 (72)	75 (73)
3xRF	103 (98)	70 (74)	99 (103)	86 (88)	97 (101)	78 (81)
4xRF	130 (139)	111 (124)	128 (128)	127 (131)	134 (138)	124 (128)
5xRF	145 (162)	140 (144)	143 (146)	134 (141)	147 (151)	140 (146)

Typical Spurious Performance: Up-Conversion

Typical spurious data is taken by mixing an input within the IF band, with LO frequencies ($\pm m \cdot LO \pm n \cdot IF$), to create a spurious output within the RF output band. The mixer is swept across the full spurious output band and the mean is calculated. The numbers shown in the table below are for a -10 dBm IF input. Spurious suppression is scaled for different IF input power levels by (n-1), where “n” is the IF spur order. For example, the 2IFx1LO spur is typically 74 dBc for a -10 dBm input with a sine-wave LO, so a -20 dBm IF input creates a spur that is (2-1) x (-10 dB) lower, or 84 dBc. Data is shown for the frequency plan in 3.6 Typical Performance.

Typical Up-conversion spurious suppression (dBc): Config A (B)

-10 dBm RF Input	0xLO	1xLO	2xLO	3xLO	4xLO	5xLO
1xIF	29 (18)	Reference	33 (33)	12 (11)	44 (37)	27 (25)
2xIF	62 (69)	74 (77)	60 (59)	78 (83)	68 (61)	72 (74)
3xIF	96 (93)	80 (81)	93 (95)	74 (77)	97 (89)	77 (75)
4xIF	121 (129)	132 (136)	120 (117)	128 (133)	114 (113)	132 (121)
5xIF	136 (150)	131 (133)	145 (151)	120 (130)	146 (141)	124 (115)

Mechanical Data

Outline Drawing

Download : [Outline 2D Drawing](#) | [Outline 3D Drawing](#) | [Outline 3D STP](#)

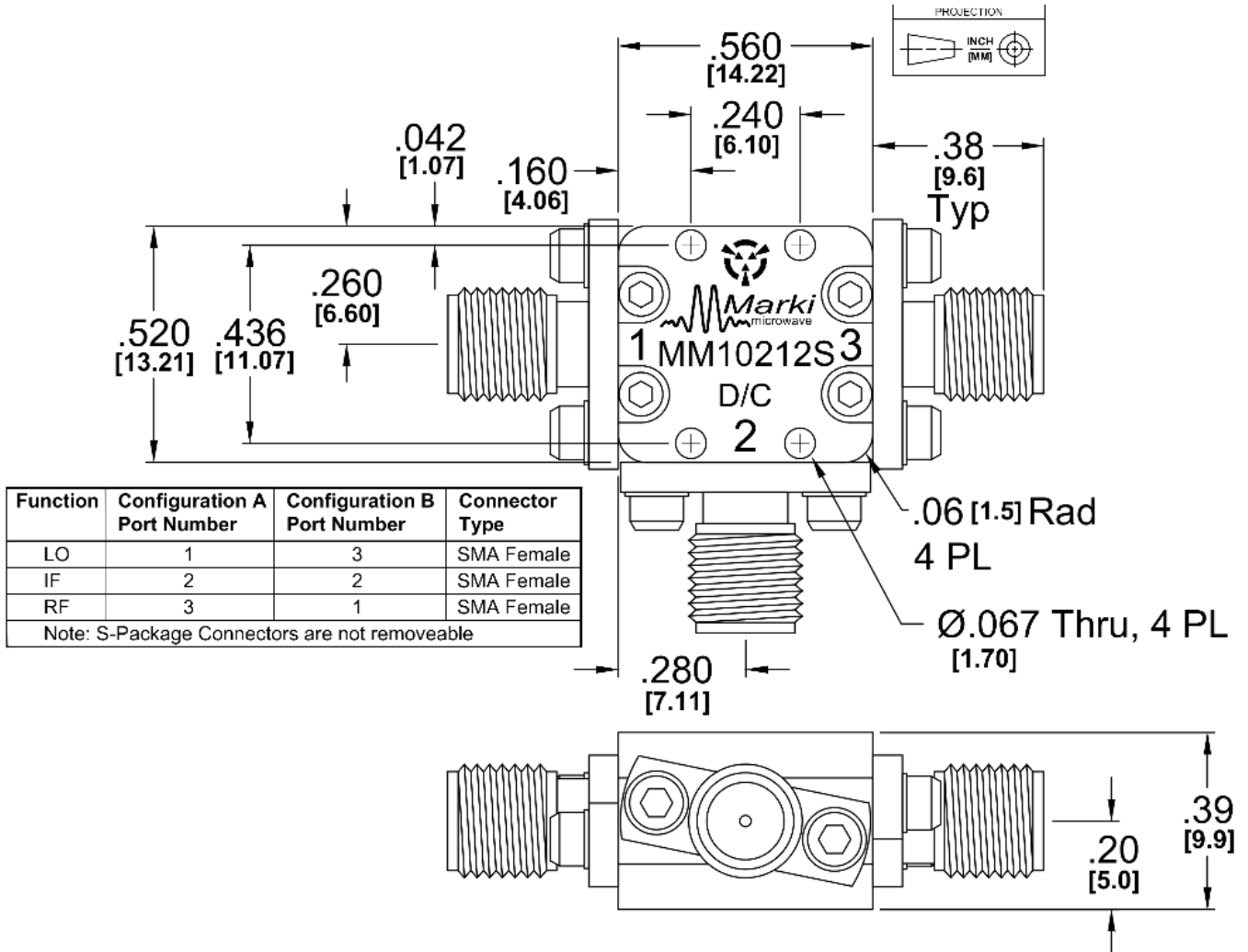

DISCLAIMER

MARKI MICROWAVE, INC., ("MARKI") PROVIDES TECHNICAL SPECIFICATIONS AND DATA (INCLUDING DATASHEETS), APPLICATION OR OTHER DESIGN ADVICE, WEB TOOLS, AND OTHER INFORMATION AND RESOURCES "AS IS" AND WITH ALL FAULTS. MARKI DISCLAIMS ALL WARRANTIES, EXPRESS OR IMPLIED, INCLUDING, WITHOUT LIMITATION, ANY IMPLIED WARRANTIES OF MERCHANTABILITY, FITNESS FOR A PARTICULAR PURPOSE, OR NON-INFRINGEMENT. These resources are intended for developers skilled in the art designing with Marki products. You are solely responsible for (1) selecting the appropriate products for your application, (2) designing, validating, and testing your application, and (3) ensuring your application meets applicable standards and other requirements. Marki makes no guarantee regarding the suitability of its products for any particular purpose, nor does Marki assume any liability whatsoever arising out of your use or application of any Marki product.

Marki grants you permission to use these resources only for development of an application that uses Marki products. Other reproduction or use of these resources is strictly prohibited. No license is granted to any other Marki intellectual property or to any third-party intellectual property. Marki reserves the right to make changes to the product(s) or information contained herein without notice.

MARKI MICROWAVE and T3 MIXER are trademarks or registered trademarks of Marki Microwave, Inc. All other trademarks used are the property of their respective owners.

© 2018 - 2019, Marki Microwave, Inc