

# BTN1-0050

## High Power Bias Tee

### DEVICE OVERVIEW

#### General Description

The BTN1-0050 is constructed using a custom-made, resonance-free conical inductor to achieve extremely broadband performance. By minimizing the overall inductor size and using proprietary packaging techniques, the BTN1-0050 is a superior option in terms of performance, reliability and ease-of-use when compared to cumbersome user-designed bias tees employing off-the-shelf conical inductors. The extremely low cutoff and resonance free operation makes the BTN1-0050 suitable for biasing amplifiers, lasers, and modulators driven with high frequency data patterns.

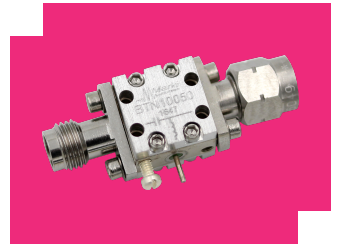

#### Features

- Broadband: 500 kHz to 50 GHz
- Low Insertion Loss
- High Power
- Non-Resonant
- Compact Size

#### Applications

- Test and Measurement Equipment

#### Functional Block Diagram

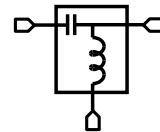

#### Part Ordering Options

Part Number	Description	Connectors	Green Status	Product Lifecycle	Export Classification
BTN1-0050	High Power Bias Tee	<u>Standard</u>	REACH RoHS	Released	EAR99

## Table Of Contents

- **Device Overview**
  - General Description
  - Features
  - Applications
  - Functional Block Diagram
- **Port Configuration and Functions**
  - Port Functions
- **Revision History**
- **Specifications**
  - Absolute Maximum Ratings
  - Package Information
  - Electrical Specifications
  - Typical Performance
  - Typical Performance vs Bias Current at Low frequencies
  - Time Domain Plots
- **Operation**
  - Application Information
- **Mechanical Data**
  - Outline Drawing

## Revision History

Revision Code	Revision Date	Comment
C	2020-10-01	Added Performance plots vs Bias current

## Port Configuration and Functions

### Port Functions

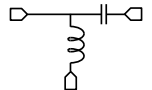
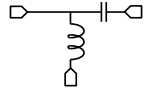
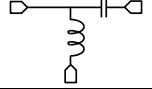
Port	Function	Connector Type	Description	DC Equivalent Circuit
Common	RF+DC	2.4M	This port is DC blocked to the RF port and DC connected to the DC port through an internal RF choke	
DC	DC	-	This port is internally connected to an RF choke which is DC connected to the RF+DC port and DC blocked to the RF port.	
RF	RF	2.4F	This port is internally DC blocked to the RF+DC and DC ports.	

**Specifications**

**Absolute Maximum Ratings**

Parameter	Maximum Rating	Unit
DC Current	1	A
DC Voltage	50	V
Maximum Storage Temperature	125	°C
Minimum Storage Temperature	-65	°C
RF Power Handling	5	W

**Package Information**

Parameter	Details	Rating
Weight	-	10g
Dimensions	-	11.94 x 11.94 mm

## Electrical Specifications

Specifications guaranteed at +25C, measured in a 50-Ohm system

Parameter	Test Conditions	Minimum Frequency (GHz)	Maximum Frequency (GHz)	Min	Typ	Max	Unit
Capacitance	-	-	-	-	100	-	nF
DC Port Isolation	-	0.0005	1	-	50	-	dB
DC Port Isolation	-	1	50	-	30	-	dB
DC Resistance	-	-	-	-	0.5	-	Ω
Inductance	-	-	-	-	22	-	μH
Insertion Loss	-	0.0005	0.004	-	2	-	dB
Insertion Loss	-	0.004	50	-	1.5	2.5	dB
Return Loss	-	0.0005	50	-	13	-	dB
Risetime/Falltime <sup>1</sup>	-	-	-	-	10	-	ps

<sup>[1]</sup> Specified as 90%/10%. Calculated from  $\tau_{bt}^2 = (\tau_{out}^2 - \tau_{in}^2)$

**Typical Performance**

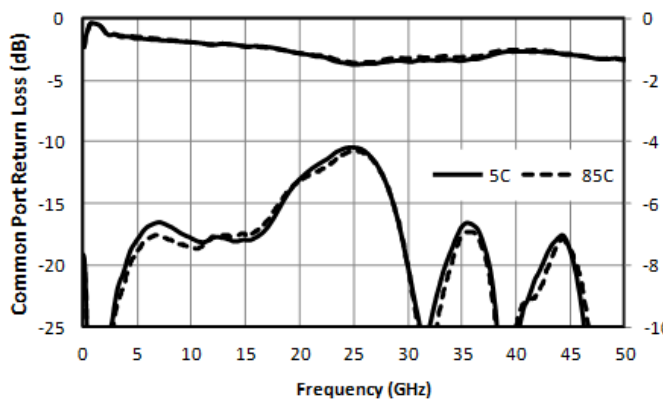
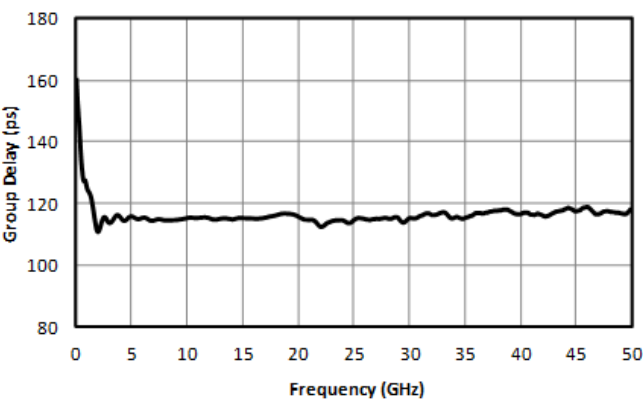
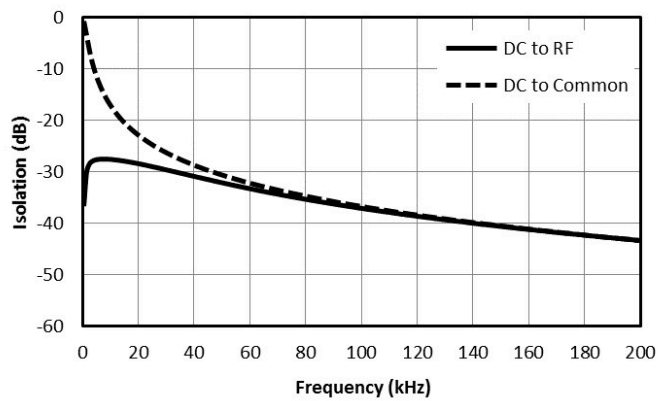
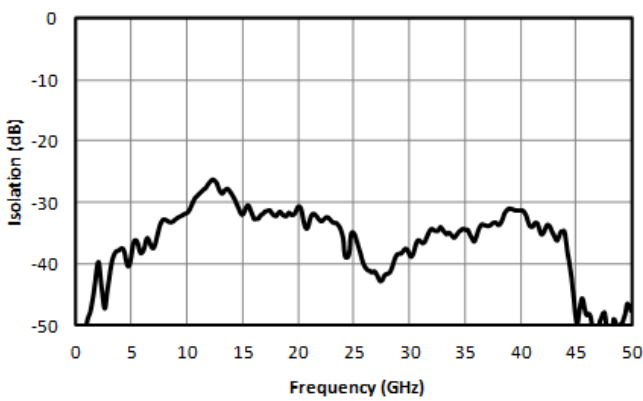
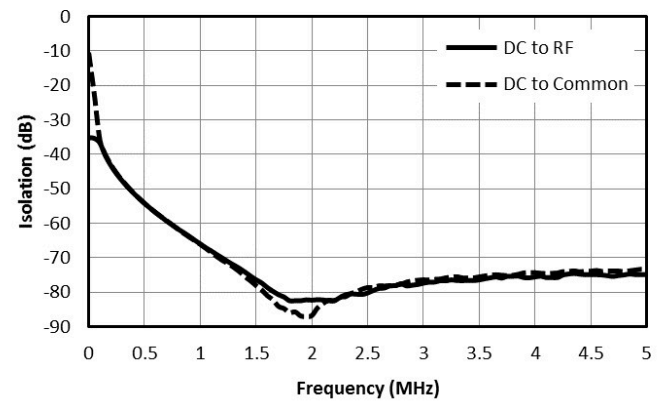
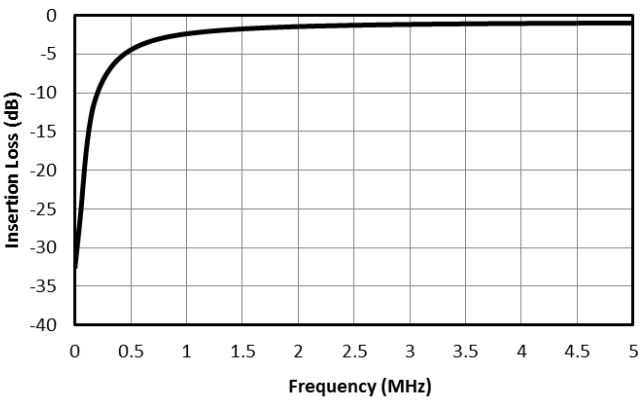
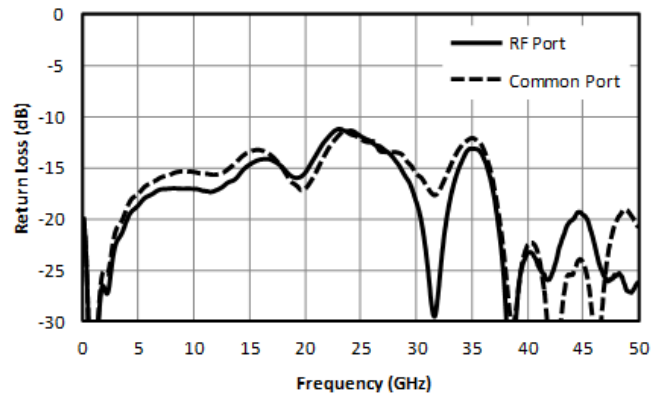
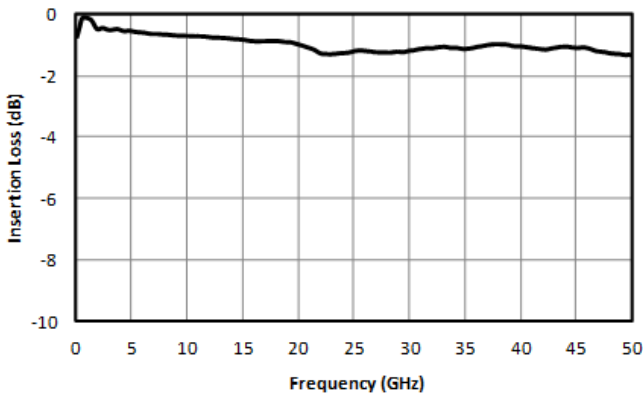

**Typical Performance vs Bias Current at Low frequencies**

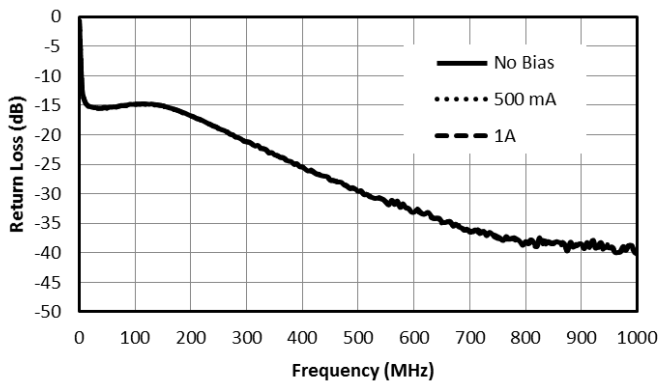
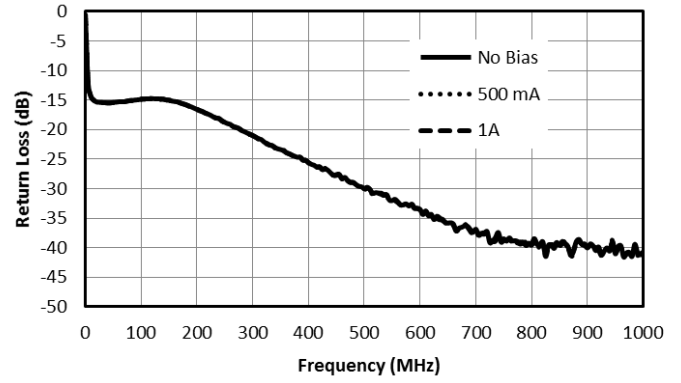
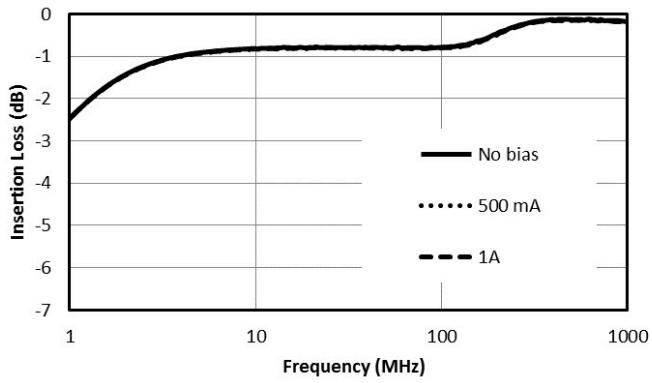

### Time Domain Plots

Oscilloscope measurements of the BTN1-0050 with a 10Gb/s PRBS pattern. Eye diagrams are taken with a  $2^{31}-1$  PRBS input demonstrating minimal eye distortion/closure afforded by the extremely low frequency operation of the bias tee.

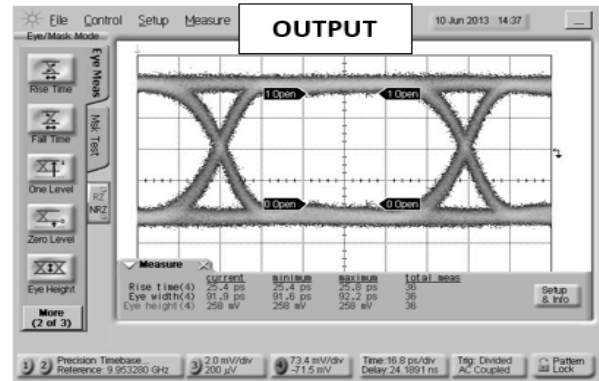
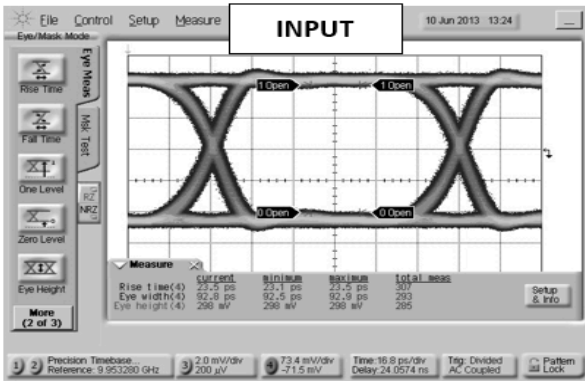

**Application Information**

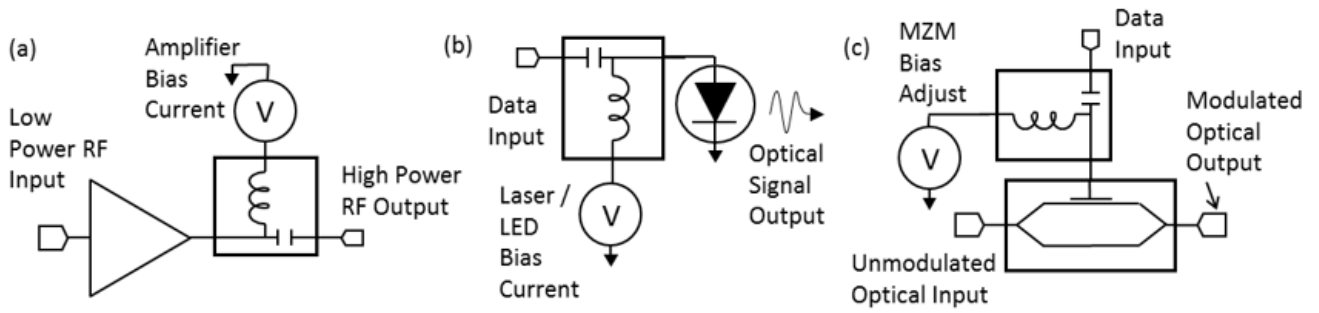

Example Schematics of a) Broadband Microwave Amplifier Biasing, b) Laser/LED Biasing for Data Communication and c) Mach-Zender Modulator Biasing for Data Communication

**Mechanical Data**

**Outline Drawing**

Download : [Outline 2D Drawing](#) | [Outline 3D Drawing](#) | [Outline 3D STP](#)

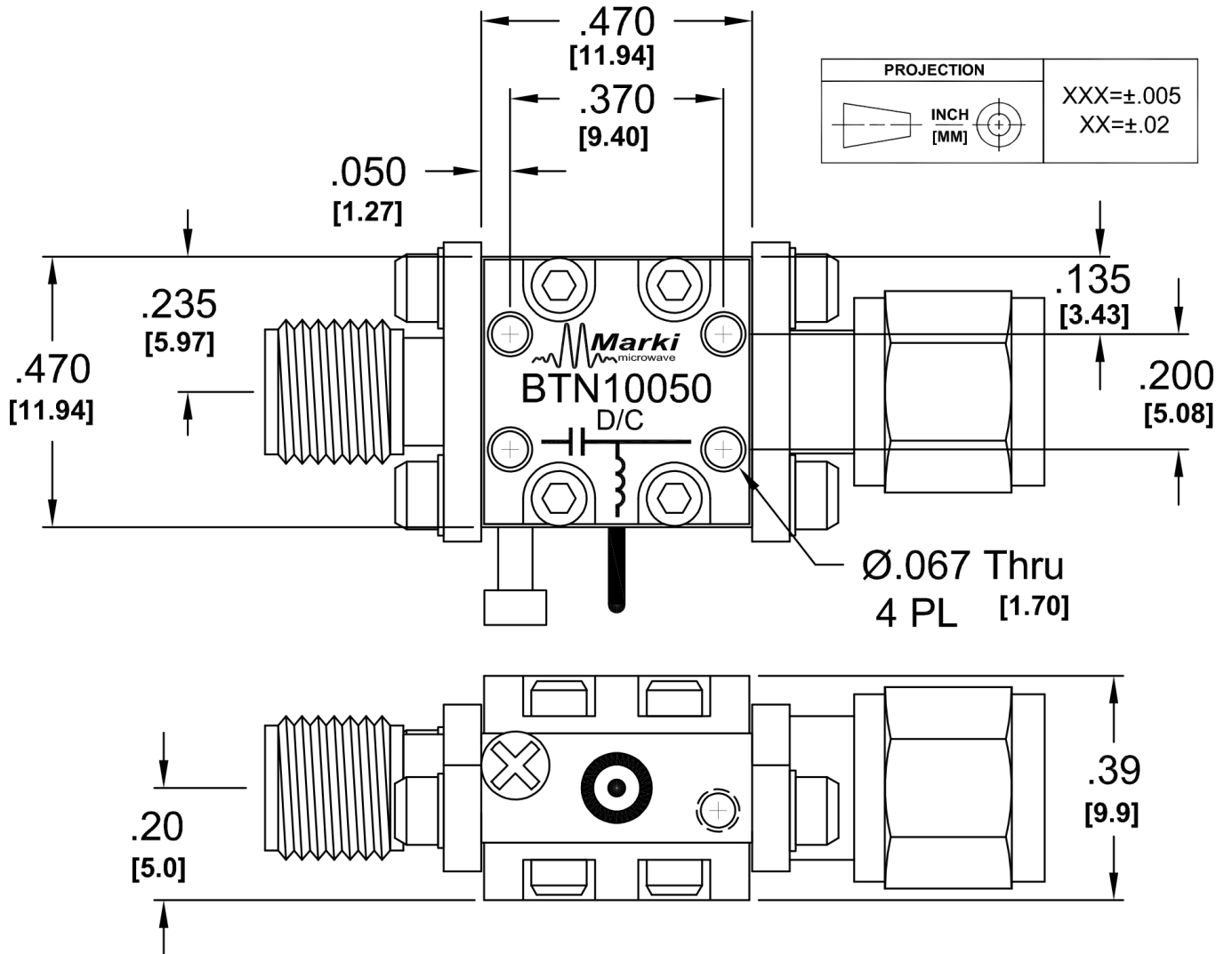

#### **DISCLAIMER**

MARKI MICROWAVE, LLC., ("MARKI") PROVIDES TECHNICAL SPECIFICATIONS AND DATA (INCLUDING DATASHEETS), APPLICATION OR OTHER DESIGN ADVICE, WEB TOOLS, AND OTHER INFORMATION AND RESOURCES "AS IS" AND WITH ALL FAULTS. MARKI DISCLAIMS ALL WARRANTIES, EXPRESS OR IMPLIED, INCLUDING, WITHOUT LIMITATION, ANY IMPLIED WARRANTIES OF MERCHANTABILITY, FITNESS FOR A PARTICULAR PURPOSE, OR NON-INFRINGEMENT.

These resources are intended for developers skilled in the art designing with Marki products. You are solely responsible for (1) selecting the appropriate products for your application, (2) designing, validating, and testing your application, and (3) ensuring your application meets applicable standards and other requirements. Marki makes no guarantee regarding the suitability of its products for any particular purpose, nor does Marki assume any liability whatsoever arising out of your use or application of any Marki product.

Marki grants you permission to use these resources only for development of an application that uses Marki products. Other reproduction or use of these resources is strictly prohibited. No license is granted to any other Marki intellectual property or to any third-party intellectual property. Marki reserves the right to make changes to the product(s) or information contained herein without notice.

MARKI MICROWAVE and T3 MIXER are trademarks or registered trademarks of Marki Microwave, LLC. All other trademarks used are the property of their respective owners.

© 2020, Marki Microwave, LLC