

MQS-0518SM

MMIC 5-18GHz 90° Splitter / Combiner

DEVICE OVERVIEW

General Description

The MQS-0518SM is a MMIC 5 GHz – 18 GHz 90° splitter/combiner. Passive GaAs MMIC technology allows production of smaller constructions that replace larger form factor circuit board constructions. Low variation allows for accurate simulations using the provided S4P file taken from measured production units. Tight fabrication tolerances allow for less unit to unit variation than traditional splitter/combiner technologies. The MQS-0518SM is available as 4X4 mm QFN Package. Evaluation boards are also available.

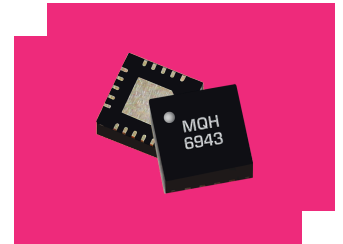

[Download s-parameters here](#)

Features

- Designed for C to Ku-band applications
- High amplitude and phase balance
- High isolation
- Low insertion loss
- Off Chip termination

Applications

- Single Sideband and Image Rejection Mixing
- IQ Modulation / Demodulation
- Balanced Amplifiers
- Microwave Correlators

Functional Block Diagram

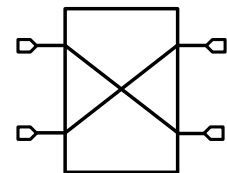

Part Ordering Options

Part Number	Description	Package	Green Status	Product Lifecycle	Export Classification
MQS-0518SM	MMIC 5-18GHz 90° Splitter / Combiner	QFN	REACH RoHS	Released	EAR99
<u>EVAL-MQS-0518</u>	Evaluation Board, MMIC 5-18GHz 90° Splitter / Combiner	EVAL	REACH RoHS	Released	EAR99

Table Of Contents

- **Device Overview**
 - General Description
 - Features
 - Applications
 - Functional Block Diagram
- **Port Configuration and Functions**
 - Port Diagram
 - Port Functions
- **Revision History**
- **Specifications**
 - Absolute Maximum Ratings
 - Package Information
 - Electrical Specifications
 - Typical Performance Plots
 - Evaluation Board Typical Performance Plots
- **Operation**
 - Application Information
- **Mechanical Data**
 - Outline Drawing
- **Footprint Image**
- **Evaluation Board**
 - Evaluation Board Outline Drawing

Revision History

Revision Code	Revision Date	Comment
-	2020-06-01	Initial Datasheet Release

Port Configuration and Functions

Port Diagram

A bottom-up view of the MQS-0518SM's SM package outline drawing is shown below. Only Pins 5 and 11 may be used as an input. Pins 1 and 15 are not recommended as inputs. Device is not recommended for applications requiring reflected signals.

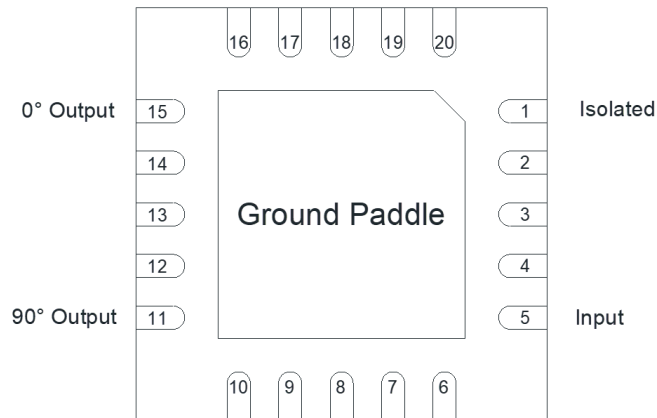

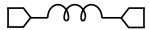
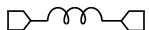

Port Functions

Configuration A

Port	Function	Description	Equivalent Circuit for Package
Pin 1	Isolated	Pin 1 is DC short to pin 11 and open to ground.	
Pin 11	90° Output	Pin 11 is DC short to pin 1 and open to ground.	
Pin 15	0° Output	Pin 15 is DC short to pin 5 and open to ground.	
Pin 5	Input	Pin 5 is DC short to pin 15 and open to ground.	

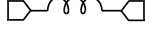
Configuration B

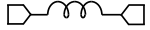
Port	Function	Description	Equivalent Circuit for Package
Pin 1	0° Output	Pin 1 is DC short to pin 11 and open to ground.	
Pin 11	Input	Pin 11 is DC short to pin 1 and open to ground.	
Pin 15	Isolated	Pin 15 is DC short to pin 5 and open to ground.	
Pin 5	90° Output	Pin 5 is DC short to pin 15 and open to ground.	

Specifications

Absolute Maximum Ratings

The Absolute Maximum Ratings indicate limits beyond which damage may occur to the device. If these limits are exceeded, the device may be inoperable or have a reduced lifetime.

Parameter	Maximum Rating	Unit
Maximum Operating Temperature	100	°C
Maximum Storage Temperature	125	°C
Minimum Operating Temperature	-55	°C
Minimum Storage Temperature	-65	°C
RF Power Handling	10	W

Package Information

Parameter	Details	Rating
Dimensions	-	4 x 4 mm
Moisture Sensitivity Level	-	MSL 1

Electrical Specifications

The electrical specifications apply at Tau=+25°C in a 50Ω system. Min and Max limits are guaranteed at Tau=+25°C.

Parameter	Port Configuration	Test Conditions	Minimum Frequency (GHz)	Maximum Frequency (GHz)	Min	Typ	Max	Unit
Amplitude Balance ¹	A	-	5	18	-	0.5	2.5	dB
Excess Through Line Insertion Loss ²	A	-	5	18	-	4.5	6	dB
Impedance	A	-	5	18	-	50	-	Ω
Isolation ³	A	-	5	18	10	17	-	dB
Mean Coupling ⁴	A	-	5	18	-	3	-	dB
Nominal Phase Shift ⁵	A	-	5	18	-	90	-	°
Phase Balance	A	-	5	18	-	2.5	10	°
VSWR ⁶	A	-	5	18	-	1.2	-	

[1][3][4][5][6] Device is non-reciprocal. Operation not guaranteed when ports 3 or 4 are used as an input.

[2] Device is non-reciprocal. Operation not guaranteed when ports 3 or 4 are used as an input. Excess Insertion Loss = (Input Port to Common Port Insertion Loss) – 3 dB.

Typical Performance Plots

All measured data is de-embedded using AFR.

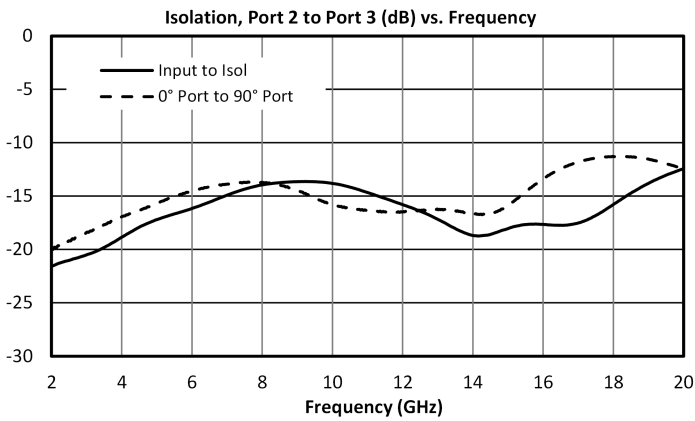
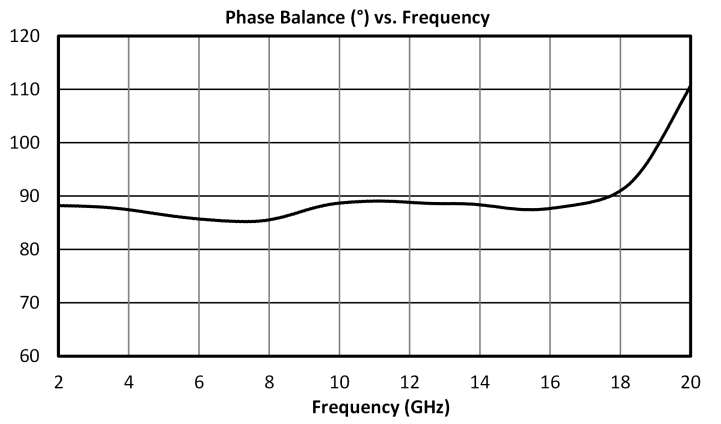
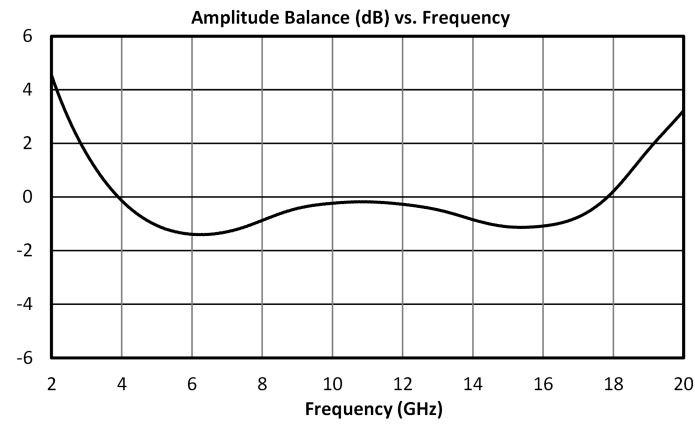
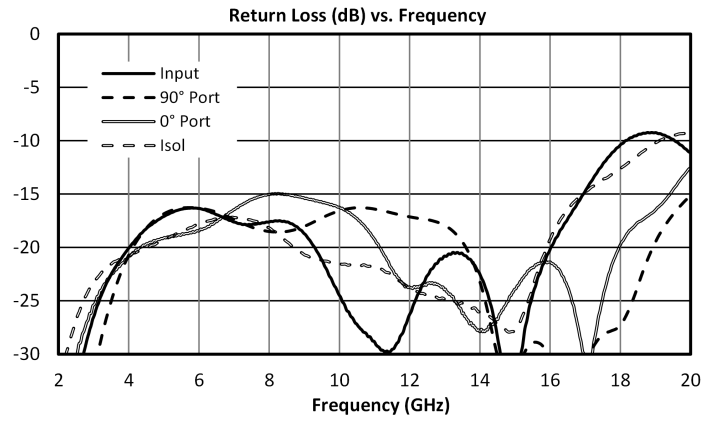
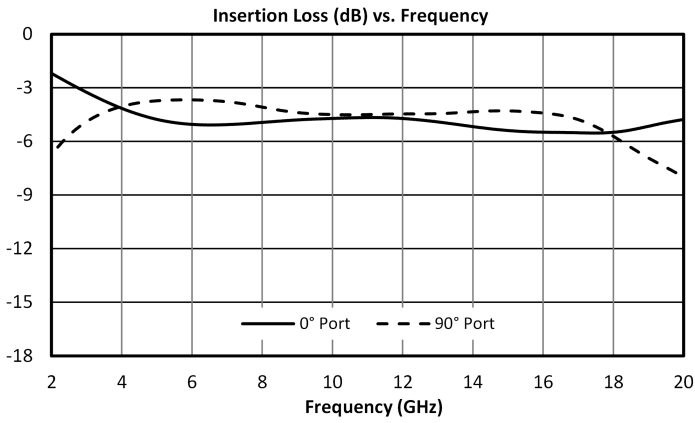

Evaluation Board Typical Performance Plots

All measured data is taken from the eval board without de-embedding of the connectors and traces. All measurements taken in a 50Ω environment.

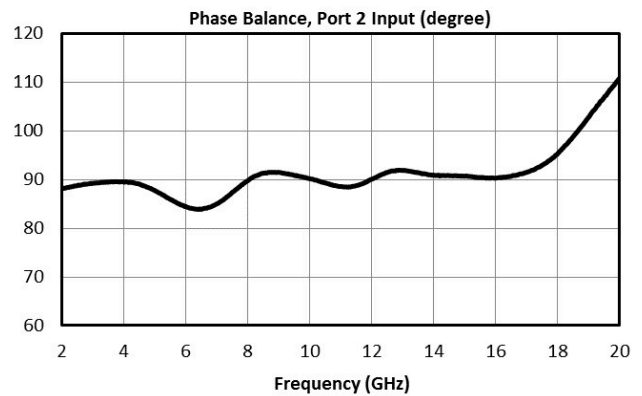
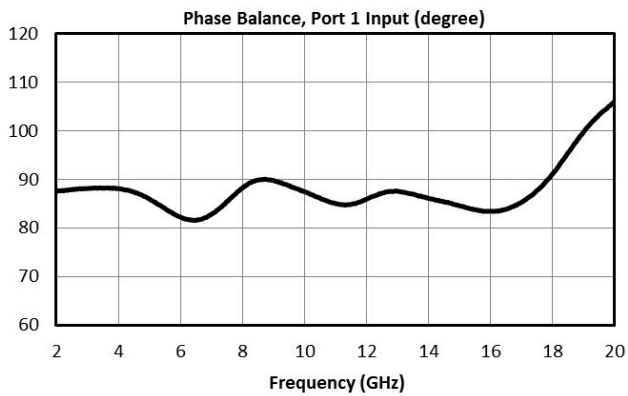
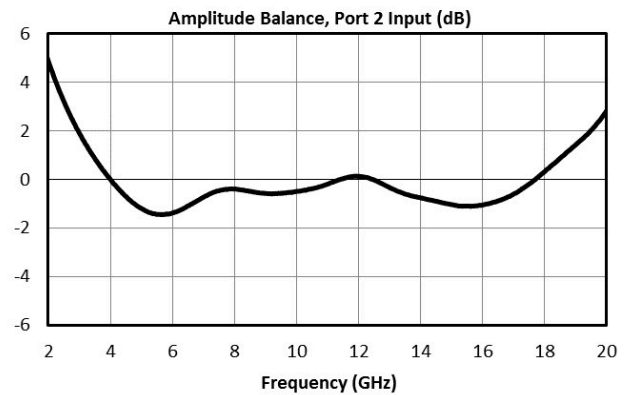
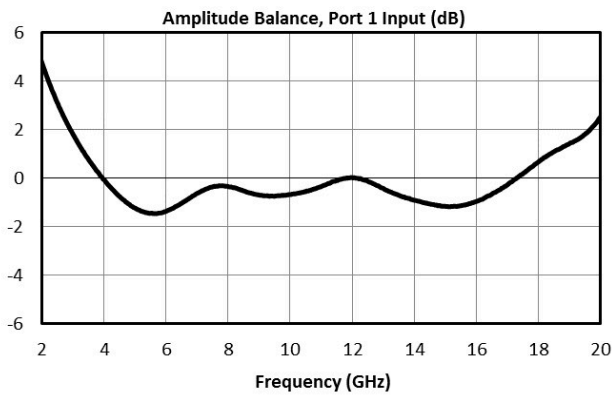
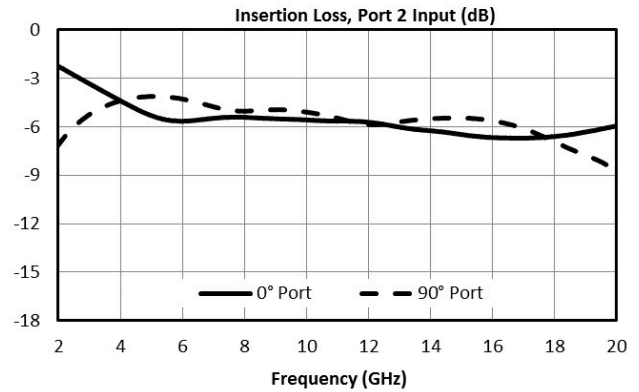
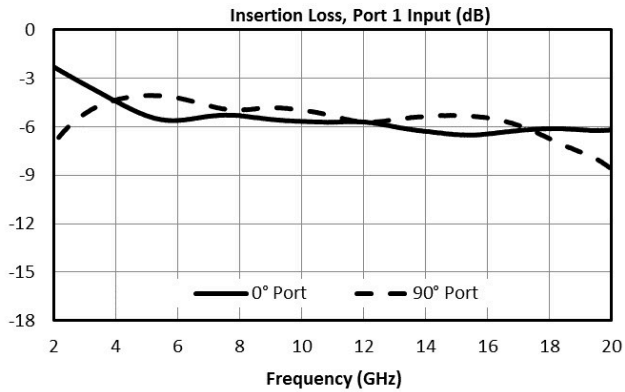

MQS-0518SM

MMIC 5-18GHz 90° Splitter / Combiner

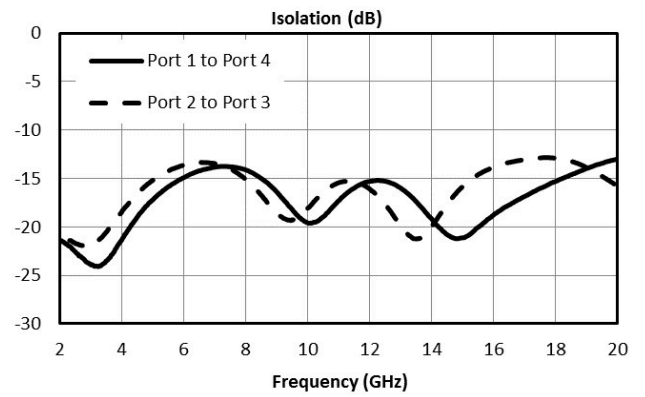
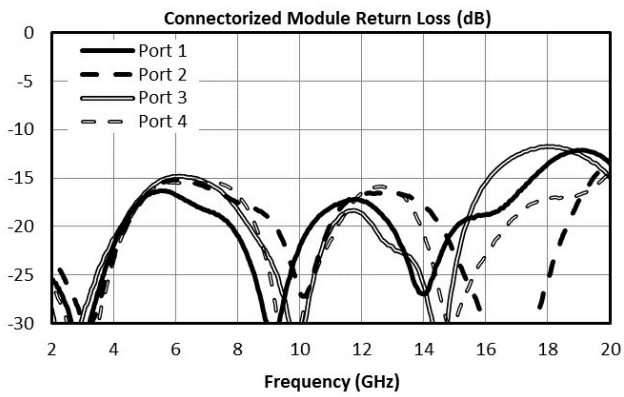

All measured data is taken from the eval board without de-embedding of the connectors and traces. 6 Ports 1 – 4 correspond to the Evaluation board package designation.

Application Information

Quadrature signal generation is useful for many applications in analog signal processing. Marki MQH (MMIC quadrature hybrids) and MQS (MMIC 90° Splitter/Combiners) offer this functionality in a small factor with high repeatability. Below are applications and how they can be realized with the MQH and MQS product lines.

Quadrature Hybrids vs 90° Splitter/Combiners

Some products are 'true' quadrature hybrids, while others are 90° Splitter/Combiners. A quadrature hybrid is symmetric about all four ports, meaning that in a splitting application any port can be used as an input, with the isolated and output ports following from this selection. Likewise, for a combining application, any port can be used as an output.

A 90° Splitter/Combiner is not symmetric. When splitting, only ports 1 and 2 can be used as an input. If ports 3 or 4 were used, there would be significant phase walk-off between the output ports. As a combiner, only ports 1 and 2 are suitable as output ports. The phase walk-off introduced when using ports 3 or 4 as an output means that reflected signals recombine and cancel poorly inside a 90° Splitter/Combiner.

Single Sideband and Image Reject Mixers

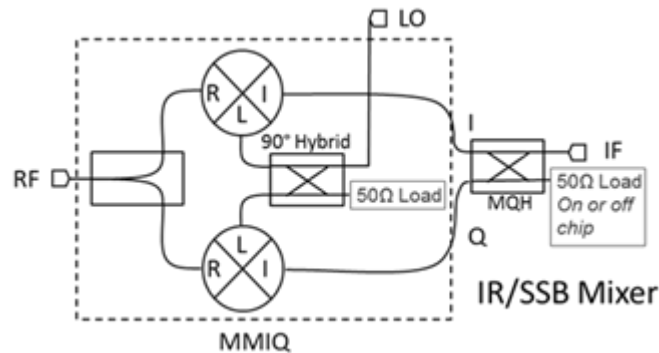

The primary application for the MQH and MQS series is as IF or LO quadrature signal splitter/combiners. They can be used in combination with the MMIQ series of IQ mixers to create broadband single sideband and image reject mixers. Either 90° Splitter/Combiners or quadrature hybrids can be used as the IF hybrid, but if a 90° Splitter/Combiner is used only one sideband (or image) is accessible, whereas if a quadrature hybrid is used than both sidebands are accessible.

If 90° Splitter/Combiner is used for a single sideband upconverter or image reject mixer, port 1 (or 2) should be used as the IF input/output and ports 2 and 3 (or 1 and 4) should be connected to the I and Q ports. Selecting port 1 or 2 to terminate will select which sideband of the mixer to reject.

Balanced Amplifiers

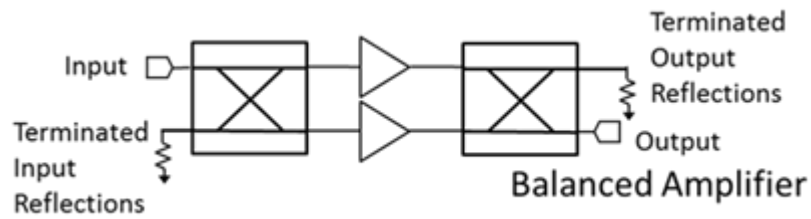

In a balanced amplifier, the poor return loss of an amplifier is compensated for with a quadrature hybrid. In this application, the reflections from the input or output are collected at the isolated port of the quadrature hybrid and terminated.

Since a 90° Splitter/Combiner is not completely symmetric, reflected signals will not terminate as well as with a quadrature hybrid. An MQH option is recommended for this application. If a 90° Splitter/Combiner is used for a single sideband upconverter or image reject mixer, port 1 (or 2) should be used as the IF input/output and ports 2 and 3 (or 1 and 4) should be connected to the I and Q ports. Selecting port 1 or 2 to terminate will select which sideband of the mixer to reject. Testing/simulation is recommended when considering if a 90° Splitter/Combiner is suitable.

Reflectionless Filter

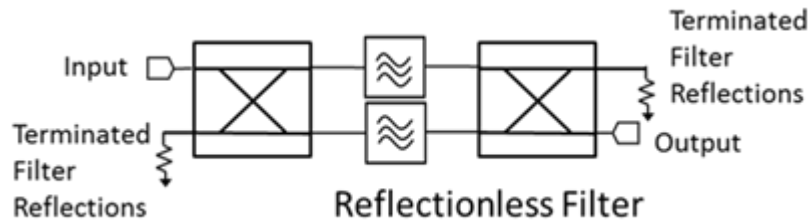

Similar to a balanced amplifier, a reflectionless filter will terminate reflections that are out of band for a filter (but in band for the quadrature hybrid) at the isolated port.

Since a 90° Splitter/Combiner is not completely symmetric, reflected signals will not terminate as well as with a quadrature hybrid. An MQH option is recommended for this application. If a 90° Splitter/Combiner is used for a single sideband upconverter or image reject mixer, port 1 (or 2) should be used as the IF input/output and ports 2 and 3 (or 1 and 4) should be connected to the I and Q ports. Selecting port 1 or 2 to terminate will select which sideband of the mixer to reject. Testing/simulation is recommended when considering if a 90° Splitter/Combiner is suitable.

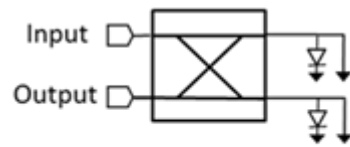

Reflective Phase Shifter

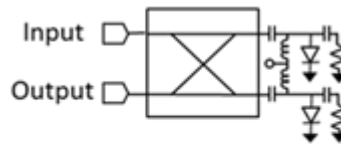

Reflective Attenuator

Mechanical Data

Outline Drawing

Download : [Outline 2D Drawing](#) | [Outline 3D Drawing](#) | [Outline 3D STP](#)

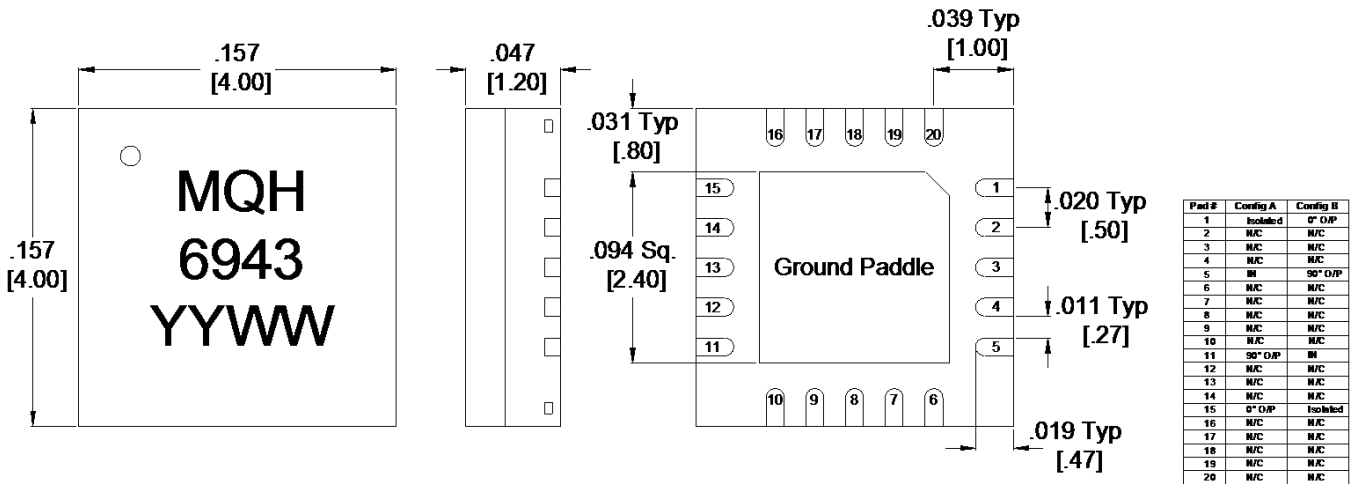

Footprint Image

Download : [Footprint Drawing](#)

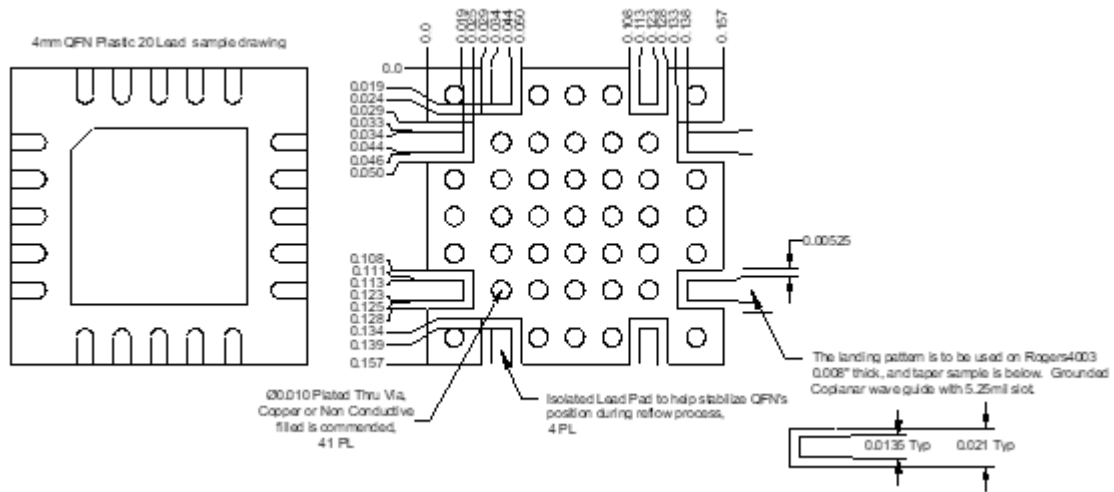

Evaluation Board - Outline Drawing

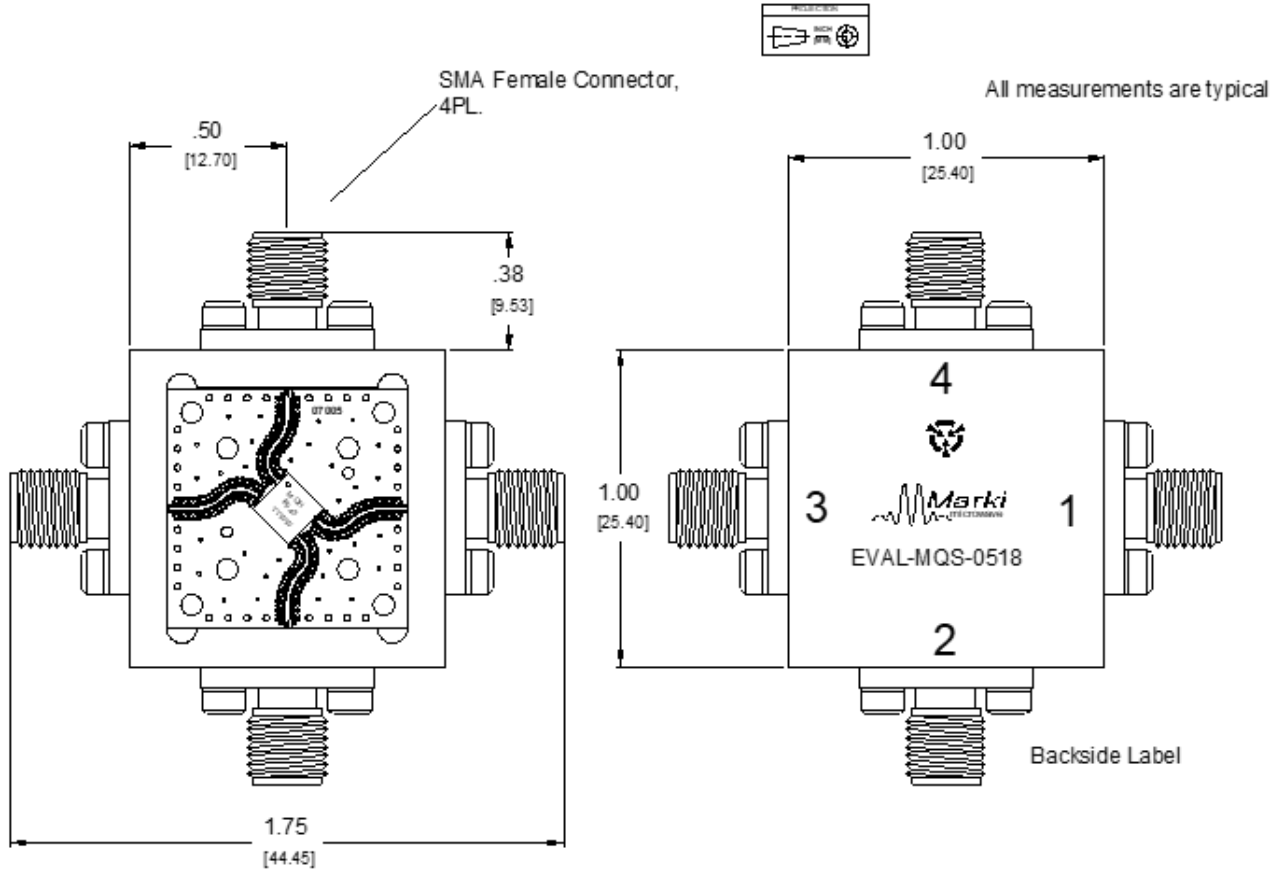

DISCLAIMER

MARKI MICROWAVE, INC., ("MARKI") PROVIDES TECHNICAL SPECIFICATIONS AND DATA (INCLUDING DATASHEETS), APPLICATION OR OTHER DESIGN ADVICE, WEB TOOLS, AND OTHER INFORMATION AND RESOURCES "AS IS" AND WITH ALL FAULTS. MARKI DISCLAIMS ALL WARRANTIES, EXPRESS OR IMPLIED, INCLUDING, WITHOUT LIMITATION, ANY IMPLIED WARRANTIES OF MERCHANTABILITY, FITNESS FOR A PARTICULAR PURPOSE, OR NON-INFRINGEMENT. These resources are intended for developers skilled in the art designing with Marki products. You are solely responsible for (1) selecting the appropriate products for your application, (2) designing, validating, and testing your application, and (3) ensuring your application meets applicable standards and other requirements. Marki makes no guarantee regarding the suitability of its products for any particular purpose, nor does Marki assume any liability whatsoever arising out of your use or application of any Marki product.

Marki grants you permission to use these resources only for development of an application that uses Marki products. Other reproduction or use of these resources is strictly prohibited. No license is granted to any other Marki intellectual property or to any third-party intellectual property. Marki reserves the right to make changes to the product(s) or information contained herein without notice.

MARKI MICROWAVE and T3 MIXER are trademarks or registered trademarks of Marki Microwave, Inc. All other trademarks used are the property of their respective owners.

© 2020, Marki Microwave, Inc